

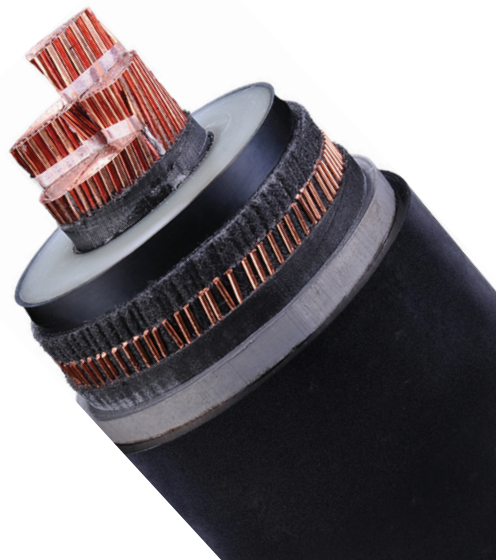

**ELSEWEDY
CABLES**

Power to Rely on



POWER CABLES





This catalogue provides technical information of over head conductors and electrical power cables up to 500 kV, which helps our valued customers to select the desired cable for their needs.

The enclosed information guides customers to define the suitable cable design, voltage, ampacity, short circuit current in addition to approximate weight and dimension of the finished cable.



Index

4	About ELSEWEDY ELECTRIC
5	ELSEWEDY ELECTRIC Facts & Figures
6	Wire, Cable & Accessories
7	Power Cables Factory
8	General information & technical data
30	Overhead conductors
48	High Temperature Low Sag (HTLS) Conductors
60	Low Voltage Cables
114	Medium Voltage Cables
146	High & Extra High Voltage Cables
158	Handling & Laying Instruction
164	Cables Clarification Sheet
166	Certifications
168	Our Partners

A global leader that has evolved from a local manufacturer of electrical products into a giant provider of integrated infrastructure solutions; with over 18,000 employees and more than USD 4.8 billion revenue. We Operate in five key business sectors: Wire, Cable & Accessories, Electrical Products, Engineering & Construction, Digital Solutions, and Infrastructure Investments. With a strong presence in 19 different countries, 31 production facilities are spread across African and Asian countries including Egypt, Algeria, KSA, Qatar, Indonesia, Pakistan, and Tanzania. We export a wide range of high-end products to over 110 countries worldwide. At the heart of our approach is an all-in-one integrated Engineering, Procurement & Construction (EPC) service which enables us to deliver the most complex turnkey projects on time and with the highest efficiency.

A vital part of our mission is ensuring that the communities where we operate develop and flourish. We work to facilitate the global transition toward a sustainable energy future, whereby we established green energy projects and smart cities across Africa, the Middle East, and Eastern Europe. In alignment with our 2030 sustainability strategy, we aim to extend and enhance our positive impact, provide energy services to a growing customer base, and drive decarbonization, digitalization, and sustainable transition in Egypt and beyond.

Our growth has been driven by hiring talents and empowering businesses and communities where we operate. We enable customers to digitize and meet the challenges of an ever-changing world. Our extensive range of digital solutions allows them to become smarter, faster, and more agile. We are committed to doing our best to serve our customers while caring for the environment. We aim to use our knowledge of our environmental impact to better develop more sustainable business scenarios and evaluate our future policies.

A leader in integrated energy, infrastructure, and digital solutions.

85+ years of evolution



Financial strength



Product diversity



Sector expertise



Geographic reach

End-to-end solutions



Power generation



Power transmission & distribution



Construction & infrastructure



Digital solutions



Projects development & Renewable energy



Industrial development

\$4.8 Billion

Revenue

27 sq Meters

of Sustainable Industrial Communities

4k+ Overhead Transmission Lines

23k+ Distribution Networks

23 Gigawatts

Total Number of Delivered Power

95+ substations

Indoor & Outdoor substations

Global Presence



31

PRODUCTION FACILITIES



19

OPERATION COUNTRIES



110

EXPORTING COUNTRIES

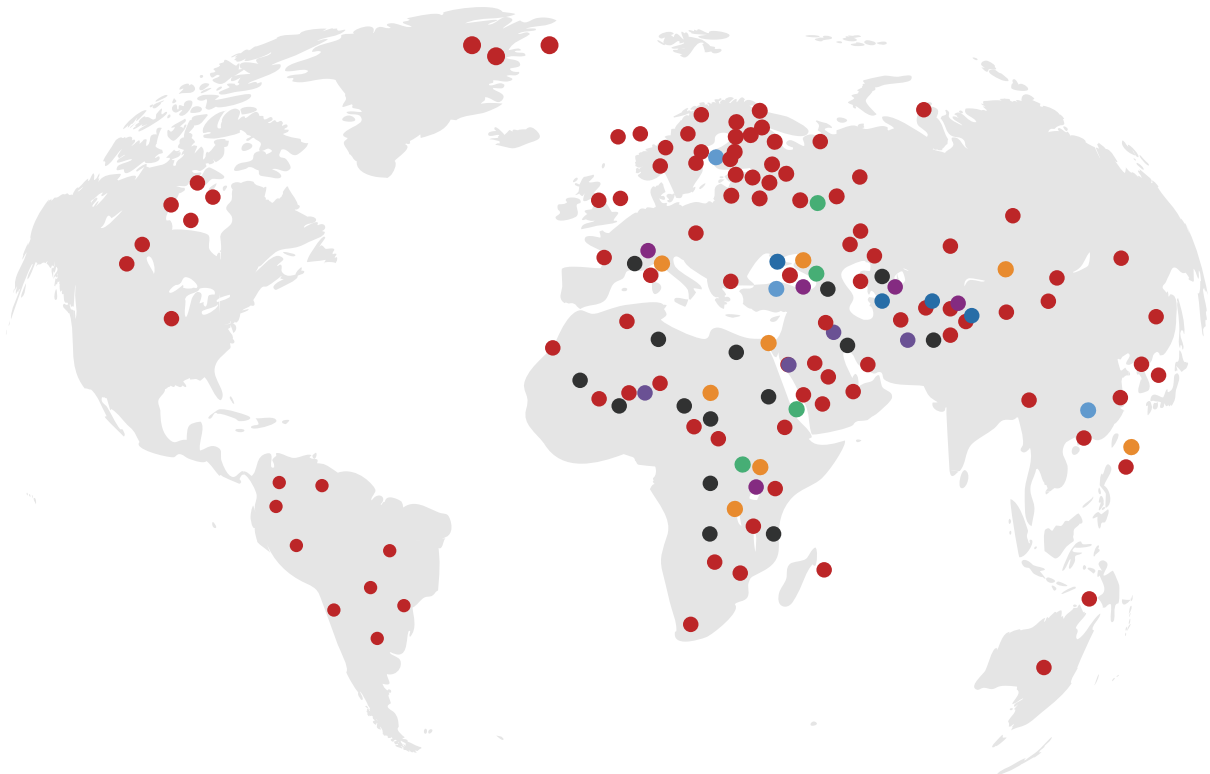

Wire, Cable, & Accessories

Electrical Products

Meters

Transformer

Telecommunication

Renewable Energy

Project Development

Export

With over 40 years of experience in the manufacturing industry, ELSEWEDY ELECTRIC'S product portfolio provides a comprehensive range of wire, cable, and accessories that comply with international standards and are recognized locally and globally. We pride ourselves on our ability to provide the most reliable, cost-effective, high-quality products and innovative solutions for our customers. With a reach of more than 100 countries and an annual production capacity of approximately 350,000 tons, we offer power, special & telecom cables, winding wires, OHTL & OPGW, steel applications, insulators, cable accessories, explosion-proof equipment, and plastics.

17 Factories

Up to **500kV**

350K+ Annual Total Capacity Wire & Cable



Energy Cables



Special & Fiber Optic Cables



OHTL & OPGW



Winding Wires



Cable Accessories



Steel Applications



Metals

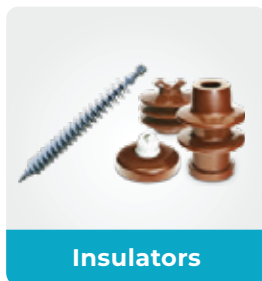

Insulators

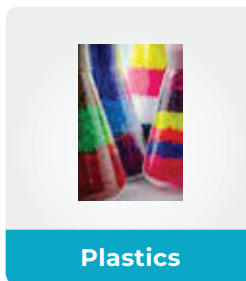

Plastics



Explosion-Proof Equipment



POWER CABLES FACTORY

Elsewedy Cables is the industry benchmark for energy cables. Starting out over 40 years ago, we have grown into Elsewedy Electric – a global, diversified energy solutions provider. We're one of the leading worldwide manufacturers of energy cables, producing low, medium, high & extra high cables, HTLS and overhead conductors.

With an area over 34,316 m², and 350,000 tons annual production capacity of wires and cables, innovative R&D labs,

17 factories worldwide, we are the go-to supplier, sub-contractor and partner for electrical projects in Africa and the Middle East.

We remain dedicated to penetrate new markets with a vision of providing the best products and services to our clients and shareholders and a first-class working environment for our employees.

General Information

Power Cable Selection:

The following factors are important for selecting the suitable cable construction:

- Voltage designation.
- Load factor.
- Required load (ampere or MVA).
- Level of short circuit current (KA) and duration (Sec).
- Environmental conditions.
- Laying conditions.

Standards:

Products described in this catalog are standard types and in accordance with the recommendation of IEC publications wherever applicable.

Power cables in accordance to other standards (BS, HD, NEMA, ASTM, AEIC, ICEA, VDE, DIN,.... etc.) or according to customer specification.

A) Standards Related to Power Cables

IEC Standards

S/N	No. of IEC	Subject
1	60028	International standard of resistance for copper.
2	60060	High-voltage test techniques
3	60104	Aluminum-magnesium-silicon alloy wire for overhead line conductors
4	60121	Recommendation for commercial annealed aluminum electrical conductor wire.
5	60173	Colours of the cores of flexible cables and cores.
6	60183	Guide to the selection of high voltage cables.
7	60227	Polyvinyl chloride insulated cables of rated voltage up to and including 450/750 V
8	60228	Conductors of insulated cables.
9	60229	Electric cables – Tests on extruded oversheaths with a special protective function
10	60230	Impulse tests on cables and their accessories.
11	60270	High-Voltage test techniques – Partial discharge measurements
12	60287	Electric cables - Calculation of the current rating.
13	60304	standard colors for insulation for low-frequency cables and wires
14	60331	Tests for electric cables under fire conditions - Circuit integrity
15	60332	Tests on electric and optical fibre cables under fire conditions
16	60502-1	Power cables with extruded insulation and their accessories for rated voltages from 1 kV (Um = 1,2 kV up to 30 kV (Um = 36 kV) - Part 1: Cables for rated voltages of 1 kV (Um = 1,2 kV) and 3 kV (Um = 3,6 kV)
17	60502-2	Power cables with extruded insulation and their accessories for rated voltages from 1 kV (Um = 1,2 kV) up to 30 kV (Um = 36 kV) – Part 2: Cables for rated voltages from 6 kV (Um = 7,2 kV) up to 30 kV (Um = 36 kV)
18	60719	Calculation of the lower and upper limits for the average outer dimensions of cables with circular copper conductors and of rated voltages up to and including 450/750 V.
19	60724	Short-circuit temperature limits of electric cables with rated voltages of 1kV (Um=1.2 kV) and 3 kV (Um=3.6 kV).
20	60754	Test on gases evolved during combustion of materials from cables.
21	60811	Electric and optical fibre cables - Test methods for non-metallic materials.
22	60840	Power cables with extruded insulation and their accessories for rated voltages above 30 kV (Um = 36 kV) up to 150 kV (Um = 170 kV) – Test methods and requirements.
23	60853	Calculation of the cyclic and emergency current rating of cables

Cont'd >>

A) Standards Related to Power Cables

IEC Standards

S/N	No. of IEC	Subject
24	60865	Short circuit currents - calculation of effects
25	60885	Electrical test methods for electric cables.
26	60888	Zinc-Coated steel wires for stranded conductors
27	60889	Hard drawn aluminum wire for overhead line conductors
28	60949	Calculation of thermally permissible short-circuits currents, taking into account non-adiabatic heating effects.
29	60986	Short-circuit temperature limits of electric cables with rated voltages from 6kV (Um=7.2 kV) and to 30 kV (Um=36 kV).
30	61034	Measurement of smoke density of cables burning under defined conditions.
31	61089	Round wire concentric lay overhead electrical stranded conductors
32	61232	Aluminum – clad steel wires for electrical purposes.
33	61394	Overhead lines - Characteristics of greases for aluminum, aluminum alloy and steel bare conductors.
34	61443	Short circuit temperature limits of electric cables with rated voltages above 30 kV (Um=36 kV).
35	61597	Overhead electrical conductors – calculation methods for stranded bare conductors.
36	TR 61901	Tests recommended on cables with a longitudinally applied metal foil for rated voltages above 30 kV (Um = 36 kV) up to and including 500 kV (Um = 550 kV).
37	62067	Power cables with extruded insulation and their accessories for rated voltages above 150 kV (Um = 170 kV) up to 500 kV (Um = 550 kV) – Test methods and requirements.
38	62095	Electric Cables –Calculations for current ratings – Finite element method.
39	62230	Electric cables – Spark-test method
40	62440	Electric cables with a rated voltage not exceeding 450/750 V - Guide to use.

A) Standards Related to Power Cables

BS Standards

S/N	No. of BS	Subject
1	2627	Wrought aluminum for electrical purposes. Wire.
2	4553	600/1000 V single-phase split concentric electric cables.
3	5467	Thermosetting insulated, armoured cables of rated voltages of 600/1000 V and 1900/3 300 V for fixed installations. Specification
4	6231	Electric cables – Single core PVC insulated flexible cables of rated voltage 600/1000V for switchgear and control gear wiring
5	6387	Test method for resistance to fire of cables required to maintain circuit integrity under fire conditions
6	6485	PVC-covered conductors for overhead power lines. equipment intended for domestic, office and similar environments
7	6622	Electric cables - Armoured cables with thermosetting insulation for rated voltages from 3.8/6.6kV to 19/33kV - Requirements and test methods.
8	6724	Thermosetting insulated, armoured cables of rated voltages of 600/1000 V and 1900/3 300 V for fixed installations, having low emission of smoke and corrosive gases when affected by fire. Specification
9	7655	Specification for insulating and sheathing materials for cables.
10	7671	Requirements for Electrical Installations
11	7835	Armoured cables with thermosetting insulation for rated voltages from 3.8/6.6 kV to 19/33 kV having low emission of smoke and corrosive gases when affected by fire. Requirements and test methods
12	7846	Thermosetting insulated, armoured, fire-resistant cables of rated voltage 600/1 000 V for fixed installations, having low emission of smoke and corrosive gases when affected by fire. Specification
13	7870	LV and MV polymeric insulated cables for use by distribution and generation utilities.
14	7884	Copper and copper-cadmium stranded conductors for overhead electric traction and power transmission systems.
15	7889	Thermosetting insulated, non-armoured cables with a voltage of 600/1 000 V, for fixed installations.
16	8573	Thermosetting insulated, non-armoured cables with a voltage of 600/1 000V, for fixed installations, having low emissions of smoke and corrosive gases when affected by fire
17	EN 10244	Steel wire and wire products - Non-ferrous metallic coatings on steel wire

» Cont'd

A) Standards Related to Power Cables

BS Standards

S/N	No. of BS	Subject
18	EN 10257	Zinc or zinc alloy coated non-alloy steel wire for armouring either power cables or telecommunication cables
19	EN 50182	Conductors for overhead lines - Round wire concentric lay stranded conductors
20	EN 50183	Conductors for overhead lines - Aluminum - magnesium - silicon alloy wires
21	EN 50189	Conductors for overhead lines - Zinc coated steel wires
22	EN 50288	Multi-element metallic cables used in analogue and digital communication and control-
23	EN 50363	Insulating, sheathing and covering materials for low voltage energy cables
24	EN 50397	covered conductors for overhead lines and the related accessories for rated voltages above 1 kV a.c. and not exceeding 36 kV a.c.
25	EN 50525-1	Low voltage energy cables of rated voltages up to and including 450/750 V (U0/U). General requirements
26	EN 50525-2-12	Low voltage energy cables of rated voltages up to and including 450/750 V (U0/U). Cables for general applications. Cables with thermoplastic PVC insulation for extensible leads
27	EN 50525-2-21	Low voltage energy cables of rated voltages up to and including 450/750 V (U0/U). Cables for general applications. Flexible cables with crosslinked elastomeric insulation
28	EN 50525-2-31	Low voltage energy cables of rated voltages up to and including 450/750 V (U0/U). Cables for general applications. Single core non-sheathed cables with thermoplastic PVC insulation
29	EN 50525-2-41	Low voltage energy cables of rated voltages up to and including 450/750 V (U0/U). Cables for general applications. Single core cables with crosslinked silicone rubber insulation
30	EN 50525-2-42	Low voltage energy cables of rated voltages up to and including 450/750 V (U0/U). Cables for general applications. Single core non-sheathed cables with crosslinked EVA insulation
31	EN ISO 9001	Quality management systems – Requirements

A) Standards Related to Power Cables

HD Standards

S/N	No. of HD	Subject
1	HD 21	Polyvinyl chloride insulated cables of rated voltages up to and including 450/750 V.
2	HD 308	Identification of cores in cables and flexible cords.
3	HD 603	Distribution cables of rated voltage 0.6/1 kV
4	HD 604	0.6/1 kV and 1.9/3.3 kV power cables with special fire performance for use in power stations.
5	HD 605	Electric cables -Additional test methods
6	HD 620	Distribution cables with extruded insulation for rated voltages from 3.6/6 (7.2) kV up to and including 20.8/36 (42) kV
7	HD 622	Power cables having rated voltages from 3.6/6 (7.2) kV up to and including 20.8/36 (42) kV with special fire performance for use in power stations.
8	HD 626	Overhead distribution cables of rated voltage U0/U (Um): 0.6/1 (1.2) kV
9	HD 627	Multi-core and multi-pair cable for insulation above and below ground.
10	HD 632	Power cables with extruded insulation and their accessories for rated voltages above 36 kV (Um = 42 kV) up to 150 kV (Um = 170 kV)

IEEE Standards

S/N	No. of IEEE	Subject
1	IEEE 738	Standard for Calculating the Current-Temperature Relationship of Bare Overhead Conductors
2	IEEE 635	Guide for Selection and Design of Aluminum Sheaths for Power Cables
3	IEEE 532	Guide for Selecting and Testing Jackets for Power, Instrumentation, and Control Cables
4	IEEE 1242	Guide for Specifying and Selecting Power, Control, and Special-Purpose Cable for Petroleum and Chemical Plants
5	IEEE 1142	Guide for the Selection, Testing, Application, and Installation of Cables having Radial-Moisture Barriers and/or Longitudinal Water Blocking
6	IEEE 1202	Standard for Flame-Propagation Testing of Wire & Cable
7	IEEE 575	Guide for Bonding Shields and Sheaths of Single-Conductor Power Cables Rated 5 kV through 500 kV
8	IEEE 576	Recommended Practice for Installation, Termination, and Testing of Insulated Power Cable as Used in Industrial and Commercial Applications

A) Standards Related to Power Cables

NF Standards

S/N	No. of NF	Subject
1	C33-226	Insulated cables and their accessories for power systems - Cross-linked polyethylene cables of rated voltages from 6/10 (12) kV up to 18/30 (36) kV with fixed gradient for distribution networks
2	C32-321	Insulated cables and conductors for installations - Rigid cross-linked polyethylene insulated cables covered with a polyvinylchloride sheath - Series U-1000 R2V and U-1000 AR2V

B) Definitions

Definitions of dimensional values:

1. Nominal value:

Value by which a quantity is designated and which is often used in tables.

NOTE: Usally, in IEC standard, nominal values give rise to values to be checked by measurements taking into account specified tolerances.

2. Approximate value:

Value which is neither guaranteed nor checked, it is used, for example, for the calculation of other dimensional values.

3. Median Value:

When several test results have been obtained and ordered in an increasing (or decreasing) succession, the median value is the middle value if the number of available values is odd, and the mean of the two middle values if the number is even.

Definitions concerning the tests:

1. Routine tests:

Tests made by the manufacturer on each manufactured length of cable to check that each length meets the specified requirements.

2. Sample tests:

Tests made by the manufacturer on samples of completed cable or components taken from a completed cable, at a specified frequency, so as to verify that the finished product meets the specified requirements.

3. Type tests:

Tests made before supplying, on a general commercial basis, a type of cable covered by the standard, in order to demonstrate satisfactory performance characteristics to meet the intended application.

NOTE: These tests are of such nature that, after they have been made, they need not be repeated, unless changes are made in the cable materials or design or manufacturing process which might change the performance characteristics.

4. Prequalification test:

Test made before supplying, on a general commercial basis, a type of cable system covered by the standard, in order to demonstrate satisfactory long term performance of the complete cable system.

5. Extension of Prequalification Test:

Test made before supplying, on a general commercial basis, a type of cable system covered by the standard, in order to demonstrate satisfactory long term performance of the complete cable system taking into account an already prequalification cable system

6. Electrical tests after installation:

Tests made to demonstrate the integrity of the cable and its accessories as installed.

C) Voltage designation:

U_0 : The rated r.m.s. power frequency voltage between each conductor and screen or sheath for which cables and accessories are designed.

U : The rated r.m.s. power frequency voltage between any two conductors for which cables and accessories are designed.

U_m : The maximum r.m.s. power frequency voltage between any two conductors for which cables and accessories are designed. It is the highest voltage that can be sustained under normal operating conditions at any time and in any point in a system.

Cables are designed by **U_0/U (U_m)** to provide guidance on compatibility with switchgear and transformers.

The following table gives the relation between **U_0** , **U** , and **U_m** in accordance with IEC 60183:

Rated voltage of cable (U_0) kV	Nominal system voltage (U) kV		Highest voltage for equipment (U_m) kV	
0.45	0.75			
0.6	1		1.2	
1.8	3		3.6	
3	3		3.6	
3.5	6		7.2	
6	6		7.2	
6	10		12	
8.7	10		12	
8.7	15		17.5	
12	20		24	
18	30		33	36
26	45		47	52
36	60	66	69	72.5
64	110		115	123
76	132		138	145
87	150		161	170
127	220		230	245

D) Technical data & Cables parameters:

1. Resistance

The conductor DC resistance values given in this catalog are based on 20°C. in case of the conductor DC resistance is required at different temperature, the following formula shall be used:

$$R_{\theta} = R_{20} [1 + \alpha(\theta-20)] \Omega/\text{Km}$$

where

R_{θ}	: conductor DC resistance at $\theta^{\circ}\text{C}$	Ω/Km
R_{20}	: conductor DC resistance at 20°C	Ω/Km
θ	: operating temperature	$^{\circ}\text{C}$
α	: temperature coefficient	$1/^{\circ}\text{C}$
	= 0.00393 for Copper	
	= 0.00403 for Aluminum	

To get AC resistance of the condcutor at operating temperature the following fromula is used

$$R_{AC} = R_{\theta} (1 + Y_p + Y_s) \Omega/\text{Km}$$

where

Y_p and Y_s are proximity and skin effect factors respectively

2. Inductance:

The self and mutual inductances are formulalted as following:

$$L = K + 0.2 \ln\left(\frac{2S}{d}\right) \text{ mh/Km}$$

where

L	: Inductance	mh/Km
K	: Constant (as self inductance)	
d	: Conductor diameter	mm
S	: Axial spacing between cables in trefoil and in case of flat formation multiply the spacing by 1.26	mm

3. capacitance:

The capacitance is formulated as following:

$$C = \frac{\epsilon_r}{18 \ln\left(\frac{D}{d}\right)} \mu\text{f/Km}$$

where

C	: Capacitance	$\mu\text{f/Km}$
ϵ_r	: relative permittivity of insulation material	
D	: Diameter over Insulation	mm
d	: Diameter under insulation	mm

4. Insulation resistance:

The insulation resistance is formulalted as following:

$$R = K \ln(D/d) \text{ M}\Omega/\text{Km}$$

where

R	: insulation resistance	$\text{M}\Omega/\text{Km}$
K	: Constant depending on the insulation material	
d	: diameter under the insulation	mm
D	: diameter over the insulation	mm

5. Charging Current:

The charging current is the capacitive current which flows through the dielectric layers when AC voltage is applied. The value can be calculated from the following equation:

$$I_c = U_0 \omega C 10^{-6} \text{ A/Km}$$

where

I_c	: Charging current	A/Km
U_0	: Rated phase voltage	V
ω	: Angular of velocity ($2\pi f$)	
f	: Frequency	Hz
C	: Capacitance	$\mu\text{f/Km}$

6. Dielectric losses

The dielectric losses of an AC cable are proportional to the capacitance, the frequency, the phase voltage squared and the power factor. The value can derived from the following equation:

$$W_d = \omega C U_0^2 \tan\delta 10^{-6} \text{ watt/Km/phase}$$

where

W_d	: Dielectric losses	watt/Km/phase
f	: Frequency	Hz
C	: Capacitance	$\mu\text{f/Km}$
U_0	: Rated phase voltage	V
$\tan\delta$: Dielectric power factor	
ω	: Angular of velocity ($2\pi f$)	

D) Technical data & Cables parameters:

7. Cable Ampacity:

Cable ampacity or current carrying capacity is defined as the continuous maximum current that cable can carry at its maximum operating temperature. The following installation conditions were assumed for the enclosed cable ampacity:

- Ambient air temperature 30(shaded) °C
- Ground temperature 20 °C
- Ground thermal resistivity 100 K.cm/Watt
- Burial depth 0.5 m
- Inner diameter of duct is 1.5 multiplied by outer cable diameter/ diameter of cables group
- Drying out of the soil is ignored.
- In case of installation conditions are different from the assumption stated. Derating factors tabulated in tables 3 to 11 shall be used for calculating the required current capacity.
- All cables ampacities are based on IEC 60287

8. Cable short circuit capacity:

Tables 13-17 give the short circuit current for both copper and aluminum conductor insulated by PVC & XLPE in accordance to table 13.

If the short circuit is required at duration not mentioned in the catalog, it is obtained by the following formula:

$$I_{s.c.t} = \frac{I_{s.c.1}}{\sqrt{t}} \quad \text{KA}$$

where

- $I_{s.c.t}$: short circuit current for t second KA
- $I_{s.c.1}$: short circuit current for 1 second KA
- t : duration Sec

9. Voltage drop:

When current flows in a cable there is a voltage drop between the ends of the cable which is the product of the current and the impedance.

the following equations should be used to calculate the voltage drop.

A. Single phase circuit

$$V_d = 2I\ell(R \cos\phi + X \sin\phi) \quad \text{v}$$

B. Three phase circuit

$$Vd=\sqrt{3}I\ell(R \cos\phi+X \sin\phi) \quad \text{v}$$

where

- V_d : Voltage drop V
- I : Load current A
- R : AC resistance Ω/Km
- X : Reactance Ω/Km
- $\text{Cos}\phi$: Power factor
- ℓ : Length Km
- $X = \omega L^{10-3}$ Ω/Km

L : Inductance
Relation between $\text{Cos}\phi$ & $\text{Sin}\phi$

Cosφ	1.0	0.9	0.8	0.71	0.6	0.5
Sinφ	0.0	0.44	0.6	0.71	0.8	0.87

- LV cable systems should be designed so as not to exceed voltage drop 3-5 % in normal operating conditions.

- Voltage drop data for LV cable (single & multi-core) are tabulated in tables 18 & 19.

10. Frequency:

Values in this catalog are based on 50 HZ frequency.

11. Load factor:

It is defined as the average power divided by the peak power, over a period of time.

In this catalog current values are calculated based on unity load factor.

E) Electrical and physical properties of Metals:

Electrical properties

Table 1

Metal	IACS 100 %	Electric alresistivity @ 20 °C Ω.m (10-8)	temperature coefficient of resistance per °C
Copper (annealed)	100	1.7241	0.00393
Copper (hard drawn)	97	1.777	0.00393
Tinned copper	95-97	1.741-1.814	0.00393
Aluminum	61	2.8264	0.00403
Lead	8	21.4	0.004

Electrical properties

Table 2

Property	Units	Copper	Aluminum	Lead
Density @ 20 °C	Kg/m ³	8890	2703	11340
Coeff. Of thermal expansion	1/°C X	17	23	29
Melting point	10 ⁻⁶ °C	1083	659	327
Thermal conductivity	W/cm °C	3.8	2.4	0.34
Ultimate tensile strength	Mn/mm ²	225	70-90	---

F) Derating Factors for Rated Currents at conditions other that specified in D.7

Air temperature derating factors

Table 3

Air temperature	15	20	25	30	35	40	45	50	55
PVC cables rated 70°C	1.21	1.15	1.07	1	0.92	0.84	0.75	0.66	0.55
XLPE cables rated 90°C	1.15	1.1	1.05	1	0.95	0.9	0.84	0.78	0.72

Ground temprature derating factors

Table 4

Ground temperature	15	20	25	30	35	40	45	50	55
PVC cables rated 70°C	1.05	1	0.95	0.89	0.84	0.77	0.71	0.63	0.55
XLPE cables rated 90°C	1.04	1	0.96	0.93	0.89	0.85	0.8	0.76	0.71

F) Derating Factors:

Burial depth de-rating factors

Table 5

Depth of laying m	Direct buried			Duct		
	Single core		Three cores	Single core		Three cores
	<= 185	> 185		<= 185	> 185	
0.5	1	1	1	1	1	1
0.6	0.98	0.98	0.99	0.98	0.98	0.99
0.8	0.96	0.94	0.96	0.96	0.95	0.97
1	0.94	0.92	0.94	0.94	0.92	0.96
1.25	0.92	0.9	0.92	0.92	0.9	0.94
1.5	0.91	0.88	0.91	0.91	0.89	0.93
1.75	0.9	0.86	0.9	0.9	0.88	0.92
2	0.89	0.85	0.89	0.89	0.87	0.91
2.5	0.88	0.83	0.88	0.88	0.85	0.9
3	0.87	0.81	0.87	0.87	0.84	0.89

Soil thermal resistivity de-rating factors

Table 6

soil thermal resistivity K.m/W	0.8	0.9	1	1.2	1.5	2	2.5	3
derating factors for direct buried cables	1.05	1.03	1	0.92	0.83	0.73	0.66	0.6
derating factors for cables in buried ducts	1.03	1.02	1	0.95	0.89	0.81	0.75	0.7

PVC rated temperature de-rating factors

Table 7

Type of PVC rated temperature °C	70	90	105
De-rating factors for cable directly buried in ground	1	1.15	1.24
De-rating factors for cable in air	1	1.28	1.46
De-rating factors for cable in duct	1	1.2	1.34

Trefoil or flat formation De-rating factors for three single core cables laid direct in ground

Table 8

Number of circuits						
	Trefoil Formation			Flat Formation		
	Touching		Spacing = 0.15 m	Spacing = 0.3 m		
nr	Trefoil	Flat	Trefoil	Flat	Trefoil	Flat
2	0.77	0.8	0.82	0.85	0.88	0.91
3	0.66	0.69	0.73	0.76	0.8	0.83
4	0.6	0.63	0.68	0.71	0.74	0.77
5	0.56	0.59	0.64	0.67	0.72	0.75
6	0.53	0.57	0.61	0.64	0.7	0.73

*L= Spacing

F) Derating Factors:

Trefoil formation De-rating factors for multi-core core cables laid direct in ground

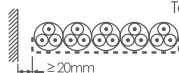
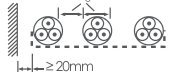
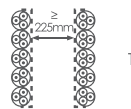

Table 9

Number of circuits	Trefoil Formation		Flat Formation			
	Touching		Spacing = 0.15 m		Spacing = 0.30 m	
	Trefoil	Flat	Trefoil	Flat	Trefoil	Flat
nr						
2	0.81	0.81	0.87	0.87	0.91	0.91
3	0.69	0.70	0.76	0.78	0.82	0.84
4	0.62	0.63	0.72	0.74	0.77	0.81
5	0.58	0.60	0.66	0.70	0.73	0.78
6	0.54	0.56	0.63	0.67	0.70	0.76

*L= Spacing

Reduction factors for groups of more than one multi-core cable in air to be applied to the current-carrying capacity for one multi-core cable in free air

Table 10

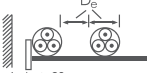
Number of trays	Number of cables						Method of installation
	1	2	3	4	6	9	
1	1.00	0.88	0.82	0.79	0.76	0.73	Cables on perforated trays 
2	1.00	0.87	0.80	0.77	0.73	0.68	
3	1.00	0.86	0.79	0.76	0.71	0.66	
1	1.00	1.00	0.98	0.95	0.91	-	Cables on perforated trays 
2	1.00	0.99	0.96	0.92	0.87	-	
3	1.00	0.98	0.95	0.91	0.85	-	
1	1.00	0.88	0.82	0.78	0.73	0.72	Cables on vertical perforated trays 
2	1.00	0.88	0.81	0.76	0.71	0.70	
1	1.00	0.91	0.89	0.88	0.87	-	
2	1.00	0.91	0.88	0.87	0.85	-	Cables on ladder supports, cleats, etc. 
1	1.00	0.87	0.82	0.80	0.79	0.78	
2	1.00	0.86	0.80	0.78	0.76	0.73	
3	1.00	0.85	0.79	0.76	0.73	0.70	Cables on ladder supports, cleats, etc. 
1	1.00	1.00	1.00	1.00	1.00	-	
2	1.00	0.99	0.98	0.97	0.96	-	
3	1.00	0.98	0.97	0.96	0.93	-	

- NOTE 1 Values given are averages for the cable types and range of conductor sizes considered. The spread of values is generally less than 5%
- NOTE 2 Factors apply to single layer groups of cables as shown above and do not apply when cables are installed in more than one layer touching each other. Values for such installations may be significantly lower and must be determined by an appropriate method.
- NOTE 3 Values are given for vertical spacing between trays of 300 mm and at least 20 mm between trays and wall. For closer spacing, the factors should be reduced.
- NOTE 4 Values are given for horizontal spacing between trays of 225 mm with trays mounted back to back. For closer spacing the factors should be reduced.

F) Derating Factors:

Reduction factors for groups of more than one circuit of single-core cables (note 2) to be applied to the current carrying capacity for one circuit of single-core cable in free air

Table 11

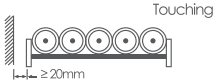
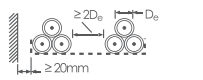
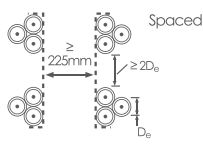
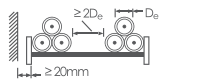
Number of trays	Number of cables			Use as a multiplier to rating for	Method of installation
	1	2	3		
1	0.98	0.91	0.87	Three cables in horizontal formation	Preforated trays (Note 3) 
2	0.96	0.87	0.81		
3	0.95	0.85	0.78		
1	1.00	0.97	0.96	Three cables in horizontal formation	Ladder supports, cleats, etc. (Note 3) 
2	0.98	0.93	0.89		
3	0.97	0.90	0.86		
1	1.00	0.98	0.96	Three cables in trefoil formation	Preforated trays (Note 3) 
2	0.97	0.93	0.98		
3	0.96	0.92	0.86		
1	1.00	0.91	0.89	Three cables in trefoil formation	Vertical perforated trays (Note 4) 
2	1.00	0.90	0.8		
3	1.00	1.00	1.00		
1	1.00	1.00	1.00	Three cables in trefoil formation	Ladder supports, cleats, etc. (Note 3) 
2	0.97	0.95	0.93		
3	0.96	0.94	0.90		

- NOTE 1 Values given are averages for the cable types and range of conductor sizes considered. The spread of values is generally less than 5%
- NOTE 2 Factors are given for single layers of cables (or trefoil groups) as shown in the table and do not apply when cables are installed in more than one layer touching each other. Values for such installations may be significantly lower and should be determined by an appropriate method.
- NOTE 3 Values are given for vertical spacings between trays of 300 mm. For closer spacing, the factors should be reduced.
- NOTE 4 Values are given for horizontal spacing between trays of 225 mm with trays mounted back to back. For closer spacing, the factors should be reduced.
- NOTE 5 For circuits having more than one cable in parallel per phase, each three phase set of conductors should be considered as a circuit for the purpose of this table.

Minimum separation between cables in air to eliminate reduction

Table 12

Arrangement of Cables	Thermal proximity effect is negligible if e/D_e is greater than or equal to
1	2
Side by side	
2 multi-core	0.5
3 multi-core	0.75
2 trefoils	1
3 trefoils	1.5
one above the other	
2 multi-core	2
3 multi-core	4
2 trefoils	4
near to a vertical surface or to a horizontal surface below the cable	0.5

Max. Short circuit temperature for Cable components

Table 13

Material	Item	Temp. °C
Insulation	PVC insulation	140 For C.S.A > 300 mm ²
		160 For C.S.A ≤ 300 mm ²
	XLPE insulation	250
Jacket	PVC sheathing	200
	LLDPE sheathing	150
	HDPE sheathing	180
Metal	Lead sheath	170
	Lead sheath - alloy	200*
	Copper	250
	Aluminum	250

* Temp. = 210 °C for cables with rated voltages above 30kV ($U_m=36$ kV).

Short Circuit Current

Short Circuit current in kA for Copper Conductors PVC insulated

Table 14

CSA mm ²	Duration in second									
	0.1	0.2	0.3	0.4	0.5	1	2	3	4	5
1.5	0.5	0.4	0.3	0.3	0.2	0.2	0.1	0.1	0.1	0.1
2.5	0.9	0.6	0.5	0.5	0.4	0.3	0.2	0.2	0.1	0.1
4	1.5	1	0.8	0.7	0.7	0.5	0.3	0.3	0.2	0.2
6	2.2	1.5	1.3	1.1	1	0.7	0.5	0.4	0.3	0.3
10	3.6	2.6	2.1	1.8	1.6	1.2	0.8	0.7	0.6	0.5
16	5.8	4.1	3.4	2.9	2.6	1.8	1.3	1.1	0.9	0.8
25	9.1	6.4	5.2	4.5	4.1	2.9	2	1.7	1.4	1.3
35	12.7	9	7.3	6.4	5.7	4	2.8	2.3	2	1.8
50	18.2	12.9	10.5	9.1	8.1	5.8	4.1	3.3	2.9	2.6
70	25.5	18	14.7	12.7	11.4	8.1	5.7	4.6	4	3.6
95	34.5	24.4	19.9	17.3	15.5	10.9	7.7	6.3	5.5	4.9
120	43.6	30.9	25.2	21.8	19.5	13.8	9.8	8	6.9	6.2
150	54.6	38.6	31.5	27.3	24.4	17.3	12.2	10	8.6	7.7
185	67.3	47.6	38.8	33.6	30.1	21.3	15	12.3	10.6	9.5
240	87.3	61.7	50.4	43.6	39	27.6	19.5	15.9	13.8	12.3
300	109.1	77.1	63	54.6	48.8	34.5	24.4	19.9	17.3	15.4
400	130	92	75.1	65	58.2	41.1	29.1	23.7	20.6	18.4
500	162.5	114.9	93.8	81.3	72.7	51.4	36.3	29.7	25.7	23
630	204.8	144.8	118.2	102.4	91.6	64.8	45.8	37.4	32.4	29
800	260.1	183.9	150.2	130	116.3	82.2	58.2	47.5	41.1	36.8

Short Circuit current in kA for Copper Conductors XLPE insulated

Table 15

CSA mm ²	Duration in second									
	0.1	0.2	0.3	0.4	0.5	1	2	3	4	5
1.5	0.7	0.5	0.4	0.3	0.3	0.2	0.2	0.1	0.1	0.1
2.5	1.1	0.8	0.7	0.6	0.5	0.4	0.3	0.2	0.2	0.2
4	1.8	1.3	1	0.9	0.8	0.6	0.4	0.3	0.3	0.3
6	2.7	1.9	1.6	1.4	1.2	0.9	0.6	0.5	0.4	0.4
10	4.5	3.2	2.6	2.3	2	1.4	1	0.8	0.7	0.6
16	7.2	5.1	4.2	3.6	3.2	2.3	1.6	1.3	1.1	1
25	11.3	8	6.5	5.7	5.1	3.6	2.5	2.1	1.8	1.6
35	15.8	11.2	9.1	7.9	7.1	5	3.5	2.9	2.5	2.2
50	22.6	16	13.1	11.3	10.1	7.2	5.1	4.1	3.6	3.2
70	31.7	22.4	18.3	15.8	14.2	10	7.1	5.8	5	4.5
95	43	30.4	24.8	21.5	19.2	13.6	9.6	7.8	6.8	6.1
120	54.3	38.4	31.3	27.1	24.3	17.2	12.1	9.9	8.6	7.7
150	67.9	48	39.2	33.9	30.4	21.5	15.2	12.4	10.7	9.6
185	83.7	59.2	48.3	41.9	37.4	26.5	18.7	15.3	13.2	11.8
240	108.6	76.8	62.7	54.3	48.6	34.3	24.3	19.8	17.2	15.4
300	135.7	96	78.4	67.9	60.7	42.9	30.4	24.8	21.5	19.2
400	181	128	104.5	90.5	80.9	57.2	40.5	33	28.6	25.6
500	226.2	160	130.6	113.1	101.2	71.5	50.6	41.3	35.8	32
630	285.1	201.6	164.6	142.5	127.5	90.1	63.7	52	45.1	40.3
800	362	256	209	181	161.9	114.5	80.9	66.1	57.2	51.2

Short Circuit Current

Short Circuit current in kA for Aluminum Conductors PVC insulated

Table 16

CSA mm ²	Duration in second									
	0.1	0.2	0.3	0.4	0.5	1	2	3	4	5
1.5	0.4	0.3	0.2	0.2	0.2	0.1	0.1	0.1	0.1	0.1
2.5	0.6	0.4	0.3	0.3	0.3	0.2	0.1	0.1	0.1	0.1
4	1	0.7	0.6	0.5	0.4	0.3	0.2	0.2	0.2	0.1
6	1.4	1	0.8	0.7	0.6	0.5	0.3	0.3	0.2	0.2
10	2.4	1.7	1.4	1.2	1.1	0.8	0.5	0.4	0.4	0.3
16	3.8	2.7	2.2	1.9	1.7	1.2	0.9	0.7	0.6	0.5
25	6	4.3	3.5	3	2.7	1.9	1.3	1.1	1	0.9
35	8.4	6	4.9	4.2	3.8	2.7	1.9	1.5	1.3	1.2
50	12	8.5	6.9	6	5.4	3.8	2.7	2.2	1.9	1.7
70	16.8	11.9	9.7	8.4	7.5	5.3	3.8	3.1	2.7	2.4
95	22.8	16.2	13.2	11.4	10.2	7.2	5.1	4.2	3.6	3.2
120	28.9	20.4	16.7	14.4	12.9	9.1	6.5	5.3	4.6	4.1
150	36.1	25.5	20.8	18	16.1	11.4	8.1	6.6	5.7	5.1
185	44.5	31.5	25.7	22.2	19.9	14.1	9.9	8.1	7	6.3
240	57.7	40.8	33.3	28.9	25.8	18.2	12.9	10.5	9.1	8.2
300	72.1	51	41.6	36.1	32.3	22.8	16.1	13.2	11.4	10.2
400	86	60.2	49.6	43	38.5	27.2	19.2	15.7	13.6	12.2
500	107.5	76	62.1	53.7	48.1	34	24	19.6	17	15.2
630	135.4	95.8	78.2	67.7	60.6	42.8	30.3	24.7	21.4	19.2
800	172	121.6	99.3	86	76.9	54.4	38.5	31.4	27.2	24.3

Short Circuit current in kA for Aluminum Conductors XLPE insulated

Table 17

CSA mm ²	Duration in second									
	0.1	0.2	0.3	0.4	0.5	1	2	3	4	5
1.5	0.4	0.3	0.3	0.2	0.2	0.1	0.1	0.1	0.1	0.1
2.5	0.7	0.5	0.4	0.4	0.3	0.2	0.2	0.1	0.1	0.1
4	1.2	0.8	0.7	0.6	0.5	0.4	0.3	0.2	0.2	0.2
6	1.8	1.3	1	0.9	0.8	0.6	0.4	0.3	0.3	0.3
10	3	2.1	1.7	1.5	1.3	0.9	0.7	0.5	0.5	0.4
16	4.8	3.4	2.8	2.4	2.1	1.5	1.1	0.9	0.8	0.7
25	7.5	5.3	4.3	3.7	3.3	2.4	1.7	1.4	1.2	1.1
35	10.5	7.4	6	5.2	4.7	3.3	2.3	1.9	1.7	1.5
50	14.9	10.6	8.6	7.5	6.7	4.7	3.3	2.7	2.4	2.1
70	20.9	14.8	12.1	10.5	9.4	6.6	4.7	3.8	3.3	3
95	28.4	20.1	16.4	14.2	12.7	9	6.3	5.2	4.5	4
120	35.9	25.4	20.7	17.9	16	11.3	8	6.5	5.7	5.1
150	44.8	31.7	25.9	22.4	20	14.2	10	8.2	7.1	6.3
185	55.3	39.1	31.9	27.6	24.7	17.5	12.4	10.1	8.7	7.8
240	71.7	50.7	41.4	35.9	32.1	22.7	16	13.1	11.3	10.1
300	89.6	63.4	51.8	44.8	40.1	28.3	20	16.4	14.2	12.7
400	119.5	84.5	69	59.8	53.4	37.8	26.7	21.8	18.9	16.9
500	149.4	105.6	86.3	74.7	66.8	47.2	33.4	27.3	23.6	21.1
630	188.2	133.1	108.7	94.1	84.2	59.5	42.1	34.4	29.8	26.6
800	239	169	138	119.5	106.9	75.6	53.4	43.6	37.8	33.8

Voltage Drop

Voltage drop for single core LV cables (0.6/1 kV)

Table 18

CSA mm ²	Copper Conductor Voltage Drop (mv / AMP / Meter)											
	PVC Insulation & PVC Sheathed						XLPE Insulation & PVC Sheathed					
	Unarmored		AL Tape Armored		AL Wire Armored		Unarmored		AL Tape Armored		AL Wire Armored	
	Flat	Trefoil	Flat	Trefoil	Flat	Trefoil	Flat	Trefoil	Flat	Trefoil	Flat	Trefoil
1.5	20.226	20.211					21.541	21.526				
2.5	12.438	12.423					13.243	13.228				
4	7.79	7.775					8.286	8.271				
6	5.245	5.23					5.575	5.56				
10	3.167	3.152					3.361	3.346				
16	2.031	2.016	2.056	2.041	2.066	2.051	2.152	2.137	2.178	2.163	2.189	2.174
25	1.326	1.311	1.348	1.333	1.357	1.342	1.402	1.387	1.425	1.409	1.434	1.419
35	0.985	0.97	1.005	0.99	1.014	0.999	1.039	1.024	1.059	1.044	1.069	1.054
50	0.753	0.738	0.77	0.755	0.778	0.763	0.791	0.776	0.809	0.794	0.818	0.803
70	0.552	0.536	0.567	0.552	0.575	0.56	0.578	0.563	0.595	0.579	0.602	0.587
95	0.427	0.412	0.44	0.425	0.447	0.432	0.444	0.429	0.458	0.443	0.465	0.45
120	0.359	0.344	0.371	0.356	0.377	0.362	0.372	0.357	0.385	0.37	0.392	0.376
150	0.311	0.296	0.321	0.306	0.327	0.312	0.322	0.307	0.333	0.318	0.339	0.324
185	0.269	0.254	0.278	0.263	0.283	0.268	0.277	0.262	0.287	0.272	0.292	0.277
240	0.229	0.214	0.237	0.222	0.242	0.227	0.234	0.219	0.243	0.228	0.248	0.233
300	0.204	0.189	0.21	0.195	0.215	0.2	0.207	0.192	0.214	0.199	0.219	0.204
400	0.182	0.167	0.189	0.174	0.193	0.178	0.185	0.169	0.192	0.177	0.196	0.181
500	0.165	0.15	0.171	0.156	0.175	0.16	0.167	0.152	0.173	0.158	0.177	0.162
630	0.152	0.137	0.157	0.142	0.16	0.145	0.154	0.139	0.159	0.144	0.162	0.146
800	0.142	0.127	0.147	0.131	0.15	0.135	0.144	0.129	0.148	0.133	0.152	0.137
1000	0.135	0.12	0.138	0.123	0.142	0.126	0.136	0.121	0.14	0.125	0.143	0.128

CSA mm ²	Aluminum Conductor Voltage Drop (mV/Amp/Meter)											
	PVC Insulation & PVC Sheathed						XLPE Insulation & PVC Sheathed					
	Unarmored		AL Tape Armored		AL Wire Armored		Unarmored		AL Tape Armored		AL Wire Armored	
	Flat	Trefoil	Flat	Trefoil	Flat	Trefoil	Flat	Trefoil	Flat	Trefoil	Flat	Trefoil
16	3.304	3.289	3.329	3.314	3.34	3.324	3.513	3.498	3.54	3.524	3.55	3.535
25	2.119	2.104	2.14	2.125	2.15	2.135	2.249	2.234	2.272	2.257	2.281	2.266
35	1.561	1.546	1.581	1.566	1.59	1.575	1.655	1.64	1.676	1.66	1.685	1.67
50	1.178	1.163	1.196	1.181	1.204	1.189	1.246	1.23	1.264	1.249	1.273	1.258
70	0.844	0.829	0.86	0.845	0.868	0.853	0.891	0.876	0.908	0.893	0.915	0.9
95	0.639	0.624	0.653	0.638	0.659	0.644	0.671	0.656	0.685	0.67	0.692	0.677
120	0.525	0.51	0.538	0.523	0.544	0.529	0.551	0.536	0.564	0.549	0.57	0.555
150	0.447	0.432	0.458	0.443	0.464	0.449	0.468	0.453	0.479	0.464	0.485	0.47
185	0.376	0.361	0.386	0.371	0.391	0.376	0.392	0.377	0.402	0.387	0.407	0.392
240	0.311	0.296	0.319	0.304	0.324	0.309	0.322	0.307	0.33	0.315	0.336	0.321
300	0.269	0.254	0.276	0.261	0.281	0.266	0.277	0.262	0.285	0.27	0.289	0.274
400	0.232	0.217	0.239	0.224	0.243	0.228	0.237	0.222	0.245	0.23	0.249	0.234
500	0.203	0.188	0.209	0.194	0.213	0.197	0.207	0.192	0.213	0.198	0.217	0.202
630	0.18	0.165	0.185	0.17	0.189	0.174	0.184	0.169	0.189	0.174	0.192	0.177
800	0.163	0.148	0.168	0.153	0.172	0.157	0.166	0.151	0.171	0.156	0.175	0.16
1000	0.151	0.136	0.155	0.14	0.158	0.143	0.153	0.138	0.157	0.142	0.161	0.146

The above data are based on:
 - Max. operating temp.: 90 °C for XLPE insulation & 70 °C for PVC insulation
 - Power factor: 0.8
 - Rated frequency: 50 Hz

Voltage Drop

Voltage Drop for Multi core L.V Cables (0.6/1 kV)

Table 19

CSA mm ²	Copper Conductor Voltage Drop (mv / AMP / Meter)	
	PVC Insulation & PVC Sheathed	XLPE Insulation & PVC Sheathed
1.5	20.175	21.489
2.5	12.392	13.195
4	7.749	8.242
6	5.207	5.534
10	3.13	3.322
16	1.998	2.117
25	1.296	1.37
35	0.957	1.009
50	0.726	0.764
70	0.527	0.553
95	0.402	0.418
120	0.334	0.347
150	0.287	0.297
185	0.246	0.254
240	0.207	0.212
300	0.182	0.185
400	0.16	0.163
500	0.144	0.145

CSA mm ²	Aluminium Conductor Voltage Drop (mv / AMP / Meter)	
	PVC Insulation & PVC Sheathed	XLPE Insulation & PVC Sheathed
16	3.271	3.478
25	2.089	2.218
35	1.533	1.625
50	1.152	1.218
70	0.82	0.866
95	0.615	0.646
120	0.501	0.526
150	0.423	0.443
185	0.354	0.369
240	0.289	0.3
300	0.247	0.255
400	0.21	0.216
500	0.181	0.186

The above data are based on:
 - Max. operating temp.: 90 °C for XLPE insulation & 70 °C for PVC insulation
 - Power factor: 0.8
 - Rated frequency: 50 Hz

Conversion Table

Table 20

Multiply	By	To Obtain
Weight-Imperial		
Ounces	28.3495	grams
Pounds (Av)	453.59	grams
Pounds (Av)	0.45359	Kilograms
Tons (short)	907.19	Kilograms
Tons (long)	1016.05	Kilograms
Weight-Metric		
Grams	0.03527	Ounces
Grams	0.002205	Pounds
Kilograms	35.274	Ounces
Kilograms	2.2046	Pounds
Kilograms	0.001102	tons (short)
Kilograms	0.0009842	tons (long)
Miscellaneous-Imperial		
Pounds per 1000 feet	1.48816	Kg/Km
Pounds per mile	0.28185	Kg/Km
Pounds per square inch	0.0007031	Kg. per square mm.
Pounds per square inch	0.07031	Kg. per square cm.
Pounds per cubic	27.68	grams per cubic cm.
Feet per second	18.288	meters per minute.
Feet per second	1.09728	Kilometers per hour.
Miles per hour	1.60935	Kilometers per hour.
Ohms per 1000 feet	3.28083	ohms per Kilometer.
Ohms per mile	0.62137	ohms per Kilometer.
Decibels per 1000 feet	3.28083	decibels per Kilometer.
Decibels per mile	0.62137	decibels per Kilometer.
Decibels	0.1153	nepers.
Miscellaneous-Metric		
Kg/Km	0.67197	pounds per 1000 feet.
Kg/Km	3.54795	pounds per mile.
Kg.per square mm	1422.34	pounds per square inch.
Kg.per square cm	14.2234	pounds per square inch.
Grams per cubic cm	0.03613	pounds per cubic inch.
Meters per minute	0.05468	feet per second.
Kilometers per hour	0.91134	feet per second.
Kilometer per hour	0.62137	miles per hour.
Ohms per Kilometer	0.3048	ohms per 1000 feet.
Ohms per Kilometer	1.6093	ohms per mile.
Decibels per kilometer	0.3048	decibels per 1000 feet.
Decibels per kilometer	1.6093	decibels per mile.
Temperature		
° Fahrenheit	5/9(°F)-32	°Celsius
° Celsius	9/5(°C)+32	°Fahrenheit
Length-Imperial		
Mils	0.001	inches.
Mils	0.0254	mm.
Inches	1000	mils.

Multiply	By	To Obtain
Inches	25.40	mm.
Inches	2.54	cm.
Feet	30.48	cm.
Feet	0.3048	meters.
Feet (thousands of)	0.3048	kilometers.
Yards	0.9144	meters.
Miles	1.6093	kilometers
Length-Metric		
Millimeters	39.37	mils.
Millimeters	0.03937	inches.
Centimeters	0.3937	inches.
Centimeters	0.032808	feet.
Meters	39.37	inches.
Meters	3.2808	feet.
Meters	1.0936	yards.
Kilometers	3280.83	feet.
Kilometers	0.62137	miles.
Area-Imperial		
Square mils	1.2732	circular mils
Square mils	0.000001	square inches
Circular mils	0.7854	square mils
Circular mils	0.0000007854	square inches
Square mils	0.0005067	square mm.
Square inches	1000000	square mils
Square inches	1273240	circualr mils
Square inches	645.16	square mm.
Square inches	6.4516	square cm.
Square feet	0.09290	square meters
Square yards	0.8361	square meters
Area-Metric		
Square millimeters	1973.52	circular mils
Square millimeters	0.00155	square inches
Square centimeters	0.155	square inches
Square meters	10.7638	square feet
Square meters	1.19599	square yards
Volume-Imperial		
Cubic inches	16.38716	cubic cm.
Cubic feet	0.028317	cubic meters
Volume-U.S.		
Quarts (liquid)	0.9463	liters
Gallons	3.7854	liters.
Volume-Metric		
Cubic cm	0.06102	cubic inches.
Cubic meters	35.3145	cubic feet.
Liters	1.05668	quarts (liquid U.S)
Liters	0.26417	gallons (U.S.)





Overhead Conductors

Product Types

1. Bare Hard and Soft Drawn Copper Conductors.
2. All Aluminum Conductor (AAC)
3. All Aluminum Alloy Conductor (AAAC)
4. Aluminum Conductor Steel reinforced (ACSR)
5. Aluminum Conductor Aluminum Clad Steel reinforced (ACSR/AW)
6. Areal Bundled Cables (ABC)

Cable Construction:

1. Conductor

Copper, Aluminum, Aluminum Alloy conductors consist of wires concentrically applied in successive layers in opposite direction.

In case of ACSR conductor a core of solid or stranded galvanized steel is applied first.

2. Insulation

In case of areal bundled cables, an extruded layer of PVC or XLPE or HDPE with 2.5 % of carbon black as UV protector is applied upon the conductor.

Bare Copper Conductor



Hard drawn conductor:

Description

Plain bare hard drawn copper conductors as per DIN 48201.

Application

Hard drawn copper conductors are used in overhead electrical distribution networks.

Bare Hard Drawn

Product Code	Cross Sectional Area	Number and Nominal Diameter of Wires	Max. DC. resistance at 20°C	Approx. overall diameter	Calculated Breaking Load	Approx. Weight
	mm ²	No x Ø (mm)	Ω/Km	mm	KN	Kg/Km
CH0-T001-U11	16	7X1.7	1.154	5.1	6.37	143
CH0-T001-U12	25	7X2.1	0.7563	6.3	9.72	218
CH0-T001-U13	35	7X2.5	0.5337	7.5	13.77	310
CH0-T001-U14	50	7X3	0.3706	9	19.84	446
CH0-T001-U14	50	19X1.8	0.3819	9	19.38	437
CH0-T001-U15	70	19X2.1	0.2806	10.5	26.38	596
CH0-T001-U16	95	19x2.5	0.198	12.5	37.39	845
CH0-T001-U17	120	19x2.8	0.1578	14	46.9	1060
CH0-T001-U18	150	37x2.25	0.1264	15.8	58.96	1337
CH0-T001-U19	185	37X2.5	0.1024	17.5	72.81	1649
CH0-T001-U20	240	61X2.25	0.07528	20.3	97.23	2209
CH0-T001-U30	300	61X2.5	0.06097	22.5	120.04	2725
CH0-T001-U40	400	61X2.89	0.0456	26	160.42	3640
CH0-T001-U50	500	61X3.23	0.0365	29.1	200.38	4545

The above data is approximate and subjected to manufacturing tolerance.

Bare Copper Conductor



Soft drawn conductor:

Description

Plain bare soft drawn copper conductors as per IEC 60228 class 2.

Application

Soft drawn copper conductors are used for grounding electrical systems, where high conductivity and flexibility are required.

Bare Soft Drawn

Product Code	Cross Sectional Area	Minimum Number of wires	Max. DC. resistance at 20°C	Approx. overall diameter	Approx. Weight
	mm ²	No	Ω/Km	mm	Kg/Km
CS0-T001-U11	16	6	1.15	4.7	137
CS0-T001-U12	25	6	0.727	5.8	216
CS0-T001-U13	35	6	0.524	6.9	297
CS0-T001-U14	50	6	0.387	8.2	405
CS0-T001-U15	70	12	0.268	9.8	586
CS0-T001-U16	95	15	0.193	11.3	815
CS0-T001-U17	120	18	0.153	12.7	1035
CS0-T001-U18	150	18	0.124	14.1	1277
CS0-T001-U19	185	30	0.0991	15.8	1595
CS0-T001-U20	240	34	0.0754	18.2	2095
CS0-T001-U30	300	34	0.0601	20.6	2623
CS0-T001-U40	400	53	0.047	23.2	3385
CS0-T001-U50	500	53	0.0366	26.6	4370

The above data is approximate and subjected to manufacturing tolerance.

All Aluminum Conductors (AAC)



Description

Hard drawn Aluminum wires, stranded in successive layers, in opposite direction to form the Aluminum stranded AAC conductor, As per BS EN 50182 or IEC 61089.

Application

All Aluminum bare conductors are used for aerial distribution lines having relatively short spans, aerial feeders and bus bars of substations.

α- According to BS EN 50182 - Germany

Product Code	Cross Sectional Area	Number and Nominal Diameter of Wires	Max. DC. resistance at 20°C	Rated strength	Approx. overall diameter	Approx. Weight	Current carrying capacity
	mm ²	No x Ø (mm)	Ω/Km	KN	mm	Kg/Km	Amp
AA0-T001-U11	16	7X1.7	1.7986	3.02	5.1	43.4	110
AA0-T001-U12	25	7X2.1	1.1787	4.36	6.3	66.3	145
AA0-T001-U13	35	7X2.5	0.8317	6.01	7.5	93.9	180
AA0-T001-U14	50	7x3	0.5776	8.41	9	135.2	225
AA0-T001-U14	50	19X1.8	0.5944	8.94	9	132.9	225
AA0-T001-U15	70	19X2.1	0.4367	11.85	10.5	180.9	270
AA0-T001-U16	95	19X2.5	0.3081	16.32	12.5	256.3	340
AA0-T001-U17	120	19x2.8	0.2456	19.89	14	321.5	390
AA0-T001-U18	150	37X2.25	0.196	26.48	15.8	405.7	455
AA0-T001-U19	185	37X2.5	0.1588	31.78	17.5	500.9	520
AA0-T001-U20	240	61X2.25	0.1193	43.66	20.3	671.1	625
AA0-T001-U30	300	61X2.5	0.0966	52.4	22.5	828.5	710
AA0-T001-U40	400	61X2.89	0.0723	68.02	26	1107.1	855
AA0-T001-U50	500	61X3.23	0.0579	82.47	29.1	1382.9	990
AA0-T001-U60	625	91X2.96	0.0464	106.45	32.6	1739.7	1140
AA0-T001-U70	800	91x3.35	0.0362	132.34	36.9	2228.3	1340
AA0-T001-U80	1000	91X3.74	0.0291	159.95	41.1	2777.3	1540

The above data is approximate and subjected to manufacturing tolerance.

Note:

Guideline values of current carrying capacity are valid up to 60 Hz, assuming an ambient temperature of 35 °C, final temperature of 80 °C wind velocity of 0.6 m/sec according to BSEN 50182 Germany Tables.

All Aluminum Conductors (AAC)



b- According to BS EN 50182 - United Kingdom

Product Code	Nominal cross sectional area	Number & nominal diameter of wires	Max. DC resistance at 20 °C	Rated strength	Approx. overall diameter	Approx. Weight	Current carrying capacity
	mm ²	No x Ø (mm)	Ω/Km	KN	mm	Kg/Km	Amp
MIDGE	23.3	7 x 2.06	1.2249	4.2	6.18	63.8	137
GNAT	26.9	7 x 2.21	1.0643	4.83	6.63	73.4	150
MOSQUITO	36.9	7 x 2.59	0.7749	6.27	7.77	100.8	183
LADYBIRD	42.8	7 x 2.79	0.6678	7.28	8.37	117	201
ANT	52.8	7 x 3.10	0.5409	8.72	9.3	144.4	230
FLY	63.6	7 x 3.40	0.4497	10.49	10.2	173.7	258
BLUEBOTTLE	73.6	7 x 3.66	0.3880	11.78	11	201.3	284
EARWIG	78.6	7 x 3.78	0.3638	12.57	11.3	214.7	296
GRASSHOPPER	84.1	7 x 3.91	0.3400	13.45	11.7	229.7	308
CLEGG	95.6	7 x 4.17	0.2989	15.3	12.5	261.3	335
WASP	106	7 x 4.39	0.2697	16.95	13.2	289.6	357
BEETLE	106.4	19 x 2.67	0.2701	18.08	13.4	292.4	358
BEE	132	7 x 4.90	0.2165	21.12	14.7	360.8	411
HORNET	157.6	19 x 3.25	0.1823	26.01	16.3	433.2	460
CATERPILLAR	185.9	19 x 3.53	0.1546	29.75	17.7	511.1	511
CHAFER	213.2	19 x 3.78	0.1348	34.12	18.9	586	558
SPIDER	237.6	19 x 3.99	0.1210	38.01	20	652.9	597
COCKROACH	265.7	19 x 4.22	0.1081	42.52	21.1	730	641
BUTTERFLY	322.7	19 x 4.65	0.0891	51.63	23.3	886.8	725
MOTH	373.1	19 x 5.00	0.0770	59.69	25	1025.3	795
DRONE	372.4	37 x 3.58	0.0774	59.59	25.1	1027.1	794
CENTIPEDE	415.2	37 x 3.78	0.0695	66.43	26.5	1145.1	850
MAYBUG	486.1	37 x 4.09	0.0593	77.78	28.6	1340.6	939
SCORPION	529.8	37 x 4.27	0.0544	84.77	29.9	1461.2	991
CICADA	628.3	37 x 4.65	0.0459	100.54	32.6	1732.9	1102

The above data is approximate and subjected to manufacturing tolerance.

Note:

Guideline values of current carrying capacity are valid up to 60 Hz, assuming an ambient temperature of 35 °C, final temperature of 80 °C wind velocity of 0.6 m/sec, sun radiation of 1000 W/m², emissivity of 0.5, absorption factor of 0.5

All Aluminum Alloy Conductors (AAAC)



Description

All Aluminum alloy (ALMELEC) conductors , stranded in successive layers to form the stranded AAAC conductor. As per IEC 61089 or BS EN 50182 or ASTM B 399.

Application

AAAC are mainly used for overhead lines , in transmission and distribution electrical networks , having relatively long spans. They are also used a messenger to support overhead electrical cables.

α- According to BS EN 50182 - Germany

Product Code	Cross Sectional Area	Number and Nominal Diameter of Wires	Max. DC. resistance at 20°C	Rated strength	Approx. overall diameter	Approx. Weight	Current carrying capacity
	mm ²	No x Ø (mm)	Ω/Km	KN	mm	Kg/Km	Amp
AA0-T001-U12	25	7X2.1	1.3566	7.15	6.3	66.2	135
AA0-T001-U13	35	7X2.5	0.9572	10.14	7.5	93.8	170
AA0-T001-U14	50	7x3	0.6647	14.6	9	135.1	210
AA0-T001-U14	50	19X1.8	0.6841	14.26	9	132.7	210
AA0-T001-U15	70	19X2.1	0.5026	19.41	10.5	180.7	255
AA0-T001-U16	95	19X2.5	0.3546	27.51	12.5	256	320
AA0-T001-U17	120	19x2.8	0.2827	34.51	14	321.2	365
AA0-T001-U18	150	37X2.25	0.2256	43.4	15.8	405.3	425
AA0-T001-U19	185	37X2.5	0.1827	53.58	17.5	500.3	490
AA0-T001-U20	240	61X2.25	0.1373	71.55	20.3	670.3	585
AA0-T001-U30	300	61X2.5	0.1112	88.33	22.5	827.5	670
AA0-T001-U40	400	61X2.89	0.0832	118.04	26	1105.9	810
AA0-T001-U50	500	61X3.23	0.0666	147.45	29.1	1381.4	930
AA0-T001-U60	625	91X2.96	0.0534	184.73	32.6	1737.7	1075
AA0-T001-U70	800	91x3.35	0.0417	236.62	36.9	2225.8	1255
AA0-T001-U80	1000	91X3.74	0.0334	294.91	41.1	2774.3	1450

The above data is approximate and subjected to manufacturing tolerance.

Note:

Guideline values of current carrying capacity are valid up to 60 Hz, assuming an ambient temperature of 35 °C, final temperature of 80 °C wind velocity of 0.6 m/sec according to BSEN 50182 Germany Tables.

All Aluminum Alloy Conductors (AAAC)



b- According to BS EN 50182 - United Kingdom

Product Code	Cross Sectional Area	Number & nominal diameter of wires	Max. DC resistance at 20 °C	Rated strength	Approx. overall diameter	Approx. Weight	Current carrying capacity
	mm ²	No x Ø (mm)	Ω/Km	KN	mm	Kg/Km	Amp
ACACIA	23.8	7 x 2.08	1.3828	7.02	6.24	64.9	130
ALMOND	30.1	7 x 2.34	1.0926	8.88	7.02	82.2	151
CEDAR	35.5	7 x 2.54	0.9273	10.46	7.62	96.8	168
DEODAR	42.2	7 x 2.77	0.7797	12.44	8.31	115.2	187
FIR	47.8	7 x 2.95	0.6875	14.11	8.85	130.6	202
HAZEL	59.9	7 x 3.30	0.5494	17.66	9.9	163.4	233
PINE	71.6	7 x 3.61	0.4591	21.14	10.8	195.6	261
HOLLY	84.1	7 x 3.91	0.3913	24.79	11.7	229.5	289
WILLOW	89.7	7 x 4.04	0.3665	26.47	12.1	245	301
OAK	118.9	7 x 4.65	0.2767	35.07	14	324.5	360
MULBERRY	150.9	19 x 3.18	0.2192	44.52	15.9	414.3	420
ASH	180.7	19 x 3.48	0.183	53.31	17.4	496.1	471
ELM	211	19 x 3.76	0.1568	62.24	18.8	579.2	519
POPLAR	239.4	37 x 2.87	0.1387	70.61	20.1	659.4	562
SYCAMORE	303.2	37 x 3.23	0.1095	89.4	22.6	835.2	654
UPAS	362.1	37 x 3.53	0.0917	106.82	24.7	997.5	732
YEW	479	37 x 4.06	0.0693	141.31	28.4	1319.6	874
TOTARA	498.1	37 x 4.14	0.0666	146.93	29	1372.1	895
RUBUS	586.9	61 x 3.50	0.0567	173.13	31.5	1622	991
SORBUS	659.4	61 x 3.71	0.0505	194.53	33.4	1822.5	1066
ARAUCARIA	821.1	61 x 4.14	0.0406	242.24	37.3	2269.4	1221
REDWOOD	996.2	61 x 4.56	0.0334	293.88	41	2753.2	1373

The above data is approximate and subjected to manufacturing tolerance.

Note:

Guideline values of current carrying capacity are valid up to 60 Hz, assuming an ambient temperature of 35 °C, final temperature of 80 °C wind velocity of 0.6 m/sec, sun radiation of 1000 W/m², emissivity of 0.5, absorption factor of 0.5.

Aluminum Conductor Steel Reinforced (ACSR)



Description

An outer layer of Aluminum conductor concentrically stranded over the central core of galvanized solid or stranded steel wires to form Aluminum steel reinforced conductor. As per BS EN 50182 or ASTM B 232 or IEC 61089.

Application

ACSR conductors are widely used for electrical power transmission over long distance. It could be used as a messenger for supporting overhead electrical cables.

α- According to BS EN 50182 - Germany

Product Code	Cross Sectional Area	Number and Nominal Diameter of Wires		Max. DC. resistance at 20°C	Rated strength	Approx. overall diameter	Approx. Weight	Current carrying capacity
		Aluminum	Steel					
	mm ²	No x Ø (mm)		Ω/Km	KN	mm	Kg/Km	Amp
ACO-T001-U11	16/2.5	6 x 1.80	1x1.80	1.8769	5.80	5.4	61.6	105
ACO-T001-U12	25/4	6 x 2.25	1x2.25	1.2012	8.95	6.75	96.3	140
ACO-T001-U13	35/6	6 x 2.70	1x2.70	0.8342	12.37	8.1	138.7	170
ACO-T001-U14	50/8	6 x 3.20	1x3.20	0.5939	16.81	9.6	194.8	210
ACO-T001-U15	70/12	26 x 1.85	7x1.44	0.4132	26.27	11.7	282.2	290
ACO-T001-U16	95/15	26 x 2.15	7x1.67	0.3060	34.93	13.6	380.6	350
ACO-T001-U17	120/20	26 x 2.44	7x1.90	0.2376	44.50	15.5	491.0	410
ACO-T001-U18	150/25	26 x 2.70	7x2.10	0.1940	53.67	17.1	600.8	470
ACO-T001-U19	185/30	26 x 3.00	7x2.33	0.1571	65.27	19.0	741.0	535
ACO-T001-U21	210/35	26 x 3.20	7x2.49	0.1381	73.36	20.3	844.1	590
ACO-T001-U20	240/40	26 x 3.45	7x2.68	0.1188	85.12	21.8	980.1	645
ACO-T001-U31	380/50	54 x 3.00	7x3.00	0.0758	121.30	27.0	1442.5	840
ACO-T001-U64	490/65	54 x 3.40	7x3.40	0.0590	150.81	30.6	1852.9	960

The above data is approximate and subjected to manufacturing tolerance.

Note:

Guideline values of current carrying capacity are valid up to 60 Hz, assuming an ambient temperature of 35 °C, final temperature of 80 °C wind velocity of 0.6 m/sec according to BSEN 50182 Germany Tables.

Aluminum Conductor Steel Reinforced (ACSR)



b- According to BS EN 50182 - United Kingdom

Product Code	Cross Sectional Area		Number and Nominal Diameter of Wires		Max. DC. resistance at 20°C Ω/Km	Rated strength KN	Approx. overall diameter mm	Approx. Weight Kg/Km	Current carrying capacity Amp
	Aluminum	Steel	Aluminum	Steel					
	mm ²		No x Ø (mm)						
MOLE	10.6	1.77	6 x 1.50	1 x 1.50	2.7027	4.14	4.50	42.8	79
SQUIRREL	21.0	3.50	6 x 2.11	1 x 2.11	1.3659	7.87	6.33	84.7	122
GOPHER	26.2	4.37	6 x 2.36	1 x 2.36	1.0919	9.58	7.08	106.0	140
WEASEL	31.6	5.27	6 x 2.59	1 x 2.59	0.9065	11.38	7.77	127.6	158
FOX	36.7	6.11	6 x 2.79	1 x 2.79	0.7812	13.21	8.37	148.1	173
FERRET	42.4	7.07	6 x 3.00	1 x 3.00	0.6757	15.27	9.00	171.2	190
RABBIT	52.9	8.81	6 x 3.35	1 x 3.35	0.5419	18.42	10.1	213.5	219
MINK	63.1	10.5	6 x 3.66	1 x 3.66	0.4540	21.67	11.0	254.9	245
SKUNK	63.2	36.9	12 x 2.59	7 x 2.59	0.4568	52.79	13.0	463.0	255
BEAVER	75.0	12.5	6 x 3.99	1 x 3.99	0.3820	25.76	12.0	302.9	273
HORSE	73.4	42.8	12 x 2.79	7 x 2.79	0.3936	61.26	14.0	537.3	280
RACCOON	78.8	13.1	6 x 4.09	1 x 4.09	0.3635	27.06	12.3	318.3	282
OTTER	83.9	14.0	6 x 4.22	1 x 4.22	0.3415	28.81	12.7	338.8	293
CAT	95.4	15.9	6 x 4.50	1 x 4.50	0.3003	32.76	13.5	385.3	318
HARE	105.0	17.5	6 x 4.72	1 x 4.72	0.2730	36.04	14.2	423.8	338
DOG	105.0	13.6	6 x 4.72	7 x 1.57	0.2733	32.65	14.2	394.0	338
COYOTE	131.7	20.1	26 x 2.54	7 x 1.91	0.2192	45.86	15.9	520.7	417
COUGAR	131.5	7.31	18 x 3.05	1 x 3.05	0.2188	29.74	15.3	418.8	413
TIGER	131.2	30.6	30 x 2.36	7 x 2.36	0.2202	57.87	16.5	602.2	421
WOLF	158.1	36.9	30 x 2.59	7 x 2.59	0.1829	68.91	18.1	725.3	474
DINGO	158.7	8.81	18 x 3.35	1 x 3.35	0.1814	35.87	16.8	505.2	465
LYNX	183.4	42.8	30 x 2.79	7 x 2.79	0.1576	79.97	19.5	841.6	521
CARACAL	184.2	10.2	18 x 3.61	1 x 3.61	0.1562	40.74	18.1	586.7	512
PANTHER	212.1	49.5	30 x 3.00	7 x 3.00	0.1363	92.46	21.0	973.1	571
JAGUAR	210.6	11.7	18 x 3.86	1 x 3.86	0.1366	46.57	19.3	670.8	550
LION	238.3	55.6	30 x 3.18	7 x 3.18	0.1213	100.47	22.3	1093.4	616
BEAR	264.4	61.7	30 x 3.35	7 x 3.35	0.1093	111.50	23.5	1213.4	658
GOAT	324.3	75.7	30 x 3.71	7 x 3.71	0.0891	135.13	26.0	1488.2	749
SHEEP	375.1	87.5	30 x 3.99	7 x 3.99	0.0771	156.30	27.9	1721.3	822
ANTELOPE	374.1	48.5	54 x 2.97	7 x 2.97	0.0773	118.88	26.7	1413.8	795
BISON	381.7	49.5	54 x 3.00	7 x 3.00	0.0758	121.30	27.0	1442.5	806
DEER	429.6	100.2	30 x 4.27	7 x 4.27	0.0673	179.00	29.9	1971.4	897
ZEBRA	428.9	55.6	54 x 3.18	7 x 3.18	0.0674	131.92	28.6	1620.8	868
ELK	477.1	111.3	30 x 4.50	7 x 4.50	0.0606	198.80	31.5	2189.5	959
CAMEL	476.0	61.7	54 x 3.35	7 x 3.35	0.0608	146.40	30.2	1798.8	928
MOOSE	528.5	68.5	54 x 3.53	7 x 3.53	0.0547	159.92	31.8	1997.3	992

The above data is approximate and subjected to manufacturing tolerance
Other types can be provided on specific request.

Note:

Guideline values of current carrying capacity are valid up to 60 Hz, assuming an ambient temperature of 35 °C, final temperature of 80 °C wind velocity of 0.6 m/sec, sun radiation of 1000 W/m², emissivity of 0.5, absorption factor of 0.5.

Aluminum Conductor Steel Reinforced (ACSR)



c- According to ASTM 232

Product Code	Cross Sectional Area		Number and Nominal Diameter of Wires		Max. DC. resistance at 20°C	Rated strength	Approx. overall diameter	Approx. Weight		Current carrying capacity
	Aluminum	Steel	Aluminum	Steel				Aluminum	Steel	
	mm ²		No x Ø (mm)					Ω/Km	KN	
GROUSE	40.5	14.12	8 x 2.54	1 x 4.24	0.7089	22.9	9.3	112	110	187
PETREL	51.6	30.1	12 x 2.34	7 x 2.34	0.5596	46.2	11.7	143	235	224
MINORCA	56.1	32.73	12 x 2.44	7 x 2.44	0.5146	50.2	12.2	156	256	236
LEGHORN	68.2	39.78	12 x 2.69	7 x 2.69	0.4234	60.5	13.5	189	311	268
GUINEA	80.4	46.88	12 x 2.92	7 x 2.92	0.3593	71.1	14.6	223	367	297
DOTTEREL	89.4	52.15	12 x 3.08	7 x 3.08	0.323	76.7	15.4	248	407	318
DORKING	96.5	56.3	12 x 3.20	7 x 3.20	0.2992	83.2	16	268	441	334
BRAHMA	102.8	91.78	16 x 2.86	19 x 2.48	0.2809	126.3	18.1	285	718	356
COCHIN	107	62.44	12 x 3.37	7 x 3.37	0.2698	91.8	16.9	297	488	357
TURKEY	13.3	2.22	6 x 1.68	1 x 1.68	2.1499	5.3	5	36	17	104
SWAN	21.2	3.53	6 x 2.12	1 x 2.12	1.3501	8.3	6.4	58	27	123
SWANATE	21.1	5.35	7 x 1.96	1 x 2.61	1.3539	10.5	6.5	58	42	123
SPARROW	33.6	5.6	6 x 2.67	1 x 2.67	0.8512	12.7	8	92	44	164
SPARATE	33.5	8.55	7 x 2.47	1 x 3.30	0.8525	16.1	8.3	92	67	165
ROBIN	42.4	7.07	6 x 3.00	1 x 3.00	0.6742	15.8	9	117	55	190
RAVEN	53.5	8.92	6 x 3.37	1 x 3.37	0.5343	19.4	10.1	147	69	220
QUAIL	67.3	11.22	6 x 3.78	1 x 3.78	0.4247	23.3	11.3	185	87	255
PIGEON	85.1	14.19	6 x 4.25	1 x 4.25	0.3359	29.4	12.8	233	110	296
PENGUIN	107.2	17.87	6 x 4.77	1 x 4.77	0.2667	37.1	14.3	294	139	342
WAXWING	135.0	7.5	18 x 3.09	1 x 3.09	0.2129	30.3	15.5	373	59	420
PARTRIDGE	134.9	21.99	26 x 2.57	7 x 2.00	0.2142	50.2	16.3	373	172	425
OSTRICH	152.2	24.7	26 x 2.73	7 x 2.12	0.1897	56.6	17.3	421	193	459
MERLIN	170.2	9.46	18 x 3.47	1 x 3.47	0.1688	38.2	17.4	470	74	487
LINNET	170.6	27.83	26 x 2.89	7 x 2.25	0.1693	62.8	18.3	472	217	494
ORIOLE	170.5	39.8	30 x 2.69	7 x 2.69	0.1698	77	18.8	473	311	562
CHICKADEE	200.9	11.16	18 x 3.77	1 x 3.77	0.1430	43.4	18.9	555	87	541
BRANT	201.6	26.13	24 x 3.27	7 x 2.18	0.1433	64.7	19.6	558	204	547
IBIS	201.3	32.73	26 x 3.14	7 x 2.44	0.1434	72.1	19.9	558	256	549
LARK	200.9	46.9	30 x 2.92	7 x 2.92	0.1442	90.3	20.4	559	367	552
PELICAN	242.3	13.46	18 x 4.14	1 x 4.14	0.1186	52.3	20.7	669	105	609

The above data is approximate and subjected to manufacturing tolerance
Other types can be provided on specific request.

» Cont'd

Note:

Guideline values of current carrying capacity are valid up to 60 Hz, assuming an ambient temperature of 35 °C, final temperature of 80 °C wind velocity of 0.6 m/sec, sun radiation of 1000 W/m², emissivity of 0.5, absorption factor of 0.5.

Aluminum Conductor Steel Reinforced (ACSR)



c- According to ASTM 232

Product Code	Cross Sectional Area		Number and Nominal Diameter of Wires		Max. DC. resistance at 20°C	Rated strength	Approx. overall diameter	Approx. Weight		Current carrying capacity
	Aluminum	Steel	Aluminum	Steel				Aluminum	Steel	
	mm ²		No x Ø (mm)					Ω/Km	KN	
FLICKER	241.6	31.4	24 x 3.58	7 x 2.39	0.1195	76.5	21.5	670	245	614
HAWK	241.6	39.2	26 x 3.44	7 x 2.67	0.1195	86.4	21.8	670	306	616
HEN	241.3	56.3	30 x 3.20	7 x 3.20	0.12	105.2	22.4	672	440	621
OSPREY	282.5	15.7	18 x 4.47	1 x 4.47	0.1017	61	22.4	779	122	672
PARAKEET	282.3	36.6	24 x 3.87	7 x 2.58	0.1023	88.3	23.2	782	285	678
DOVE	282.6	45.92	26 x 3.72	7 x 2.89	0.1022	101.1	23.6	784	359	681
EAGLE	282.1	65.82	30 x 3.46	7 x 3.46	0.1026	123	24.2	783	514	686
PEACOCK	306.1	39.8	24 x 4.03	7 x 2.69	0.0943	95.8	24.2	850	311	714
SQUAB	305.8	49.8	26 x 3.87	7 x 3.01	0.0945	108.1	24.5	849	390	716
WOODDUCK	307.1	71.65	30 x 3.61	7 x 3.61	0.0943	129	25.3	853	559	724
TEAL	307.1	69.62	30 x 3.61	19 x 2.16	0.0943	133.4	25.2	853	545	723
SWIFT	323	8.97	36 x 3.38	1 x 3.38	0.089	60.6	23.7	891	70	714
KINGBIRD	323	17.95	18 x 4.78	1 x 4.78	0.089	69.7	23.9	891	139	731
ROOK	323.1	41.9	24 x 4.14	7 x 2.76	0.0894	101	24.8	896	326	739
GROSBEAK	321.8	52.49	26 x 3.97	7 x 3.09	0.0897	111.9	25.2	893	409	740
SCOTER	322.6	75.26	30 x 3.70	7 x 3.70	0.0897	135.5	25.9	895	588	747
EGRET	322.6	73.54	30 x 3.70	19 x 2.22	0.0897	140.6	25.9	895	575	747
FLAMINGO	337.3	43.72	24 x 4.23	7 x 2.82	0.0856	105.4	25.4	936	342	759
GANNET	338.3	54.9	26 x 4.07	7 x 3.16	0.0854	117.2	25.8	936	429	764
STILT	363.3	46.88	24 x 4.39	7 x 2.92	0.0795	113.4	26.3	1005	367	796
STARLING	361.9	59.15	26 x 4.21	7 x 3.28	0.0798	126	26.7	1004	461	797
REDWING	362.1	82.41	30 x 3.92	19 x 2.35	0.08	153.7	27.4	1006	646	804
CUCKOO	402.3	52.15	24 x 4.62	7 x 3.08	0.0718	123.8	27.7	1116	408	850
DRAKE	402.6	65.44	26 x 4.44	7 x 3.45	0.0717	139.7	28.1	1117	511	853
TERN	403.8	27.83	45 x 3.38	7 x 2.25	0.0715	97.5	27	1115	217	829
COOT	401.9	11.16	36 x 3.77	1 x 3.77	0.0715	72.9	26.4	1111	87	821
CONDOR	402.3	52.15	54 x 3.08	7 x 3.08	0.0718	124.3	27.7	1115	407	833
MALLARD	403.8	91.78	30 x 4.14	19 x 2.48	0.0717	171.2	29	1119	718	861
RUDDY	455.5	31.67	45 x 3.59	7 x 2.40	0.0634	109.3	28.7	1263	246	896
CANARY	456.3	59.15	54 x 3.28	7 x 3.28	0.0633	141.9	29.5	1263	461	903

The above data is approximate and subjected to manufacturing tolerance
Other types can be provided on specific request.

» Cont'd

Note:

Guideline values of current carrying capacity are valid up to 60 Hz, assuming an ambient temperature of 35 °C, final temperature of 80 °C wind velocity of 0.6 m/sec, sun radiation of 1000 W/m², emissivity of 0.5, absorption factor of 0.5.

Aluminum Conductor Steel Reinforced (ACSR)



c- According to ASTM 232

Product Code	Cross Sectional Area		Number and Nominal Diameter of Wires		Max. DC. resistance at 20°C	Rated strength	Approx. overall diameter	Approx. Weight		Current carrying capacity
	Aluminum	Steel	Aluminum	Steel				Aluminum	Steel	
	mm ²		No x Ø (mm)					Ω/Km	KN	
RAIL	483.8	33.54	45 x 3.70	7 x 2.47	0.0597	116	29.6	1339	261	923
CATBIRD	484.6	13.46	36 x 4.14	1 x 4.14	0.0593	87.9	29	1335	105	919
CARDINAL	484.5	62.81	54 x 3.38	7 x 3.38	0.0596	149.7	30.4	1338	490	929
ORTOLAN	523.9	36.31	45 x 3.85	7 x 2.57	0.0551	123.3	30.8	1450	283	969
TANAGER	522.8	14.52	36 x 4.30	1 x 4.30	0.055	94.8	30.1	1444	113	963
CURLEW	522.5	67.73	54 x 3.51	7 x 3.51	0.0553	161.5	31.6	1450	529	975
BLUEJAY	565.5	38.9	45 x 4.00	7 x 2.66	0.0511	132.7	32	1568	304	1012
FINCH	565	71.57	54 x 3.65	19 x 2.19	0.0514	174.6	32.9	1574	560	1017
BUNTING	605.8	41.88	45 x 4.14	7 x 2.76	0.0477	142.4	33.1	1680	326	1057
GRACKLE	602.8	76.89	54 x 3.77	19 x 2.27	0.0481	184.2	34	1679	602	1059
BITTERN	644.4	44.66	45 x 4.27	7 x 2.85	0.0448	151.6	34.2	1786	348	1097
PHEASANT	645.1	81.71	54 x 3.90	19 x 2.34	0.045	194	35.1	1797	639	1106
SKYLARK	643.3	17.87	36 x 4.77	1 x 4.77	0.0447	117.2	33.4	1782	140	1088
DIPPER	684.2	47.2	45 x 4.40	7 x 2.93	0.0422	160.7	35.2	1882	370	1138
MARTIN	685.4	86.67	54 x 4.02	19 x 2.41	0.0423	206.1	36.2	1910	679	1146
BOBOLINK	725.2	50.14	45 x 4.53	7 x 3.02	0.0398	170.5	36.2	2010	392	1176
PLOVER	726.9	91.78	54 x 4.14	19 x 2.48	0.0399	218.4	37.2	2014	719	1184
NUTHATCH	746.2	52.83	45 x 4.65	7 x 3.10	0.0378	177.6	37.2	2120	413	1214
PARROT	766.1	97.03	54 x 4.25	19 x 2.55	0.038	230.5	38.2	2134	758	1220
LAPWING	807.5	55.6	45 x 4.78	7 x 3.18	0.0359	187.4	38.2	2239	435	1250
FALCON	806.2	102.43	54 x 4.36	19 x 2.62	0.036	243	39.3	2246	802	1260

The above data is approximate and subjected to manufacturing tolerance
Other types can be provided on specific request.

Note:

Guideline values of current carrying capacity are valid up to 60 Hz, assuming an ambient temperature of 35 °C, final temperature of 80 °C wind velocity of 0.6 m/sec, sun radiation of 1000 W/m², emissivity of 0.5, absorption factor of 0.5.

Aluminum Conductor Aluminum Clad Steel Reinforced (ACSR/AW)



Description

An outer layer of Aluminum conductor concentrically stranded over the central core of aluminum clad steel solid or stranded to form Aluminum Conductor Aluminum Clad Steel Reinforced. As per ASTM B549.

Application

ACSR/AW conductors are used for electrical power transmission, they are ideal for long overhead lines spans like ACSR but with slightly better resistance and current carrying capacity in addition to good corrosion resistance.

According to ASTM 549

Product Code	Cross Sectional Area		Number and Nominal Diameter of Wires		Max. DC. resistance at 20°C	Rated strength	Approx. overall diameter	Approx. Weight	Current carrying capacity
	Aluminum	Steel	Aluminum	Steel					
	mm ²		No x Ø (mm)						
FALCON/AW	806	102.43	54x4.36	19x2.62	0.0345	236	39.26	2917	1310
LAPWING/AW	806	55.6	45x4.78	7x3.18	0.0351	186	38.22	2598	1288
PARROT/AW	765	97.03	54x4.25	19x2.55	0.0363	224	38.25	2768	1271
NUTHATCH/AW	765	52.83	45x4.65	7x3.10	0.0369	176	37.2	2467	1245
PLOVER/AW	725	91.78	54x4.14	19x2.48	0.0384	212	37.24	2625	1230
BOBOLINK/AW	725	50.14	45x4.53	7x3.02	0.0389	167	36.24	2336	1205
MARTIN/AW	685	86.67	54x4.02	19x2.41	0.0406	200	36.17	2478	1185
DIPPER/AW	685	47.2	45x4.40	7x2.93	0.0412	157	35.19	2207	1164
PHEASANT/AW	645	81.71	54x3.90	19x2.34	0.0432	189	35.1	2333	1141
BITTERN/AW	645	44.66	45x4.27	7x2.85	0.0438	148	34.17	2078	1121
SKYLARK/AW	645	17.95	36x4.78	1x4.78	0.0441	114	33.46	1893	1111
GRACKLE/AW	604	76.89	54x3.77	19x2.27	0.0461	177	33.97	2188	1093
BUNTING /AW	604	41.88	45x4.14	7x2.76	0.0466	139	33.12	1948	1079
FINCH/AW	564	71.57	54x3.65	19x2.19	0.0493	168	32.85	2043	1049
BLUEJAY/AW	564	38.9	45x4.00	7x2.66	0.0499	130	31.98	1819	1033
CURLEW/AW	524	67.73	54x3.51	7x3.51	0.053	155	31.59	1896	1003
ORTOLAN /AW	524	36.31	45x3.85	7x2.57	0.0539	121	30.81	1688	984
TANAGER/AW	524	14.52	36x4.30	1x4.30	0.0545	93	30.1	1537	974
CARDINAL/AW	483	62.81	54x3.38	7x3.38	0.0571	146	30.42	1752	956
RAIL/AW	483	33.54	45x3.70	7x2.47	0.0583	114	29.61	1558	938
CATBIRD/AW	483	13.46	36x4.14	1x4.14	0.0588	87	28.98	1420	929
CANARY/AW	456	59.15	54x3.28	7x3.28	0.0607	137	29.52	1653	920
RUDDY/AW	456	31.67	45x3.59	7x2.40	0.0619	107	28.74	1470	903
MALLARY/AW	403	91.78	30x4.14	19x2.48	0.0666	165	28.96	1726	894
CONDOR/AW	403	52.15	54x3.08	7x3.08	0.0688	123	27.72	1458	850
TERN/AW	403	27.83	45x3.38	7x2.25	0.0699	95	27.03	1298	837
DRAKE/AW	403	65.44	26x4.44	7x3.45	0.068	135	28.11	1549	877
CUCKOO/AW	403	52.15	24x4.62	7x3.08	0.0688	122	27.72	1460	868
COOT/AW	403	11.16	36x3.77	1x3.77	0.0708	72	26.39	1183	825
REDWING/AW	363	82.41	30x3.92	19x2.35	0.0742	148	27.43	1552	832

The above data is approximate and subjected to manufacturing tolerance
Other types can be provided on specific request.

» Cont'd

Note:

Guideline values of current carrying capacity are valid up to 60 Hz, assuming an ambient temperature of 35 °C, final temperature of 80 °C wind velocity of 0.6 m/sec, sun radiation of 1000 W/m², emissivity of 0.5, absorption factor of 0.5.

Aluminum Conductor Aluminum Clad Steel Reinforced (ACSR/AW)



According to ASTM 549

Product Code	Cross Sectional Area		Number and Nominal Diameter of Wires		Max. DC. resistance at 20°C	Rated strength	Approx. overall diameter	Approx. Weight	Current carrying capacity
	Aluminum	Steel	Aluminum	Steel					
	mm ²		No x Ø (mm)						
STARLING/AW	363	59.15	26x4.21	7x3.28	0.0756	122	26.68	1393	819
STILT/AW	363	46.88	24x4.39	7x2.92	0.0762	110	26.32	1314	814
GANNET/AW	338	54.9	26x4.07	7x3.16	0.0809	115	25.76	1298	785
FLAMINGO/AW	338	43.72	24x4.23	7x2.82	0.082	102	25.38	1225	776
EGRET/AW	322	73.54	30x3.70	19x2.22	0.0833	133	25.9	1381	775
SOOTER/AW	322	75.26	30x3.70	7x3.70	0.0831	131	25.9	1391	776
GROSBK/AW	322	52.49	26x3.97	7x3.09	0.085	110	25.15	1238	760
ROOK/AW	322	41.88	24x4.14	7x2.76	0.0856	98	24.84	1168	755
SWIFT/AW	322	8.97	36x3.38	1x3.38	0.0882	60	23.66	946	724
KINGBIRD/AW	322	17.95	18x4.78	1x4.78	0.0873	67	23.9	1006	738
TEAL/AW	307	69.62	30x3.61	19x2.16	0.0875	127	25.24	1314	751
WOOD DUCK/AW	307	71.65	30x3.61	7x3.61	0.0873	127	25.27	1323	752
SQUAB/AW	307	49.81	26x3.87	7x3.01	0.0895	105	24.51	1177	736
PEACOCK/AW	307	39.78	24x4.03	7x2.69	0.0903	93	24.19	1112	730
EAGLE/AW	282	65.82	30x3.46	7x3.46	0.0951	119	24.22	1217	710
DOVE/AW	282	45.92	26x3.72	7x2.89	0.0968	98	23.55	1083	700
PARAKEET/AW	282	36.6	24x3.87	7x2.58	0.098	86	23.22	1022	693
OSPRAY/AW	282	15.69	18x4.47	1x4.47	0.0998	59	22.35	880	678
HEN/AW	242	56.3	30x3.20	7x3.20	0.1112	103	22.42	1043	645
HAWK/AW	242	39.49	26x3.44	7x2.68	0.1132	84	21.8	929	633
FLICKER/AW	242	31.4	24x3.58	7x2.39	0.1145	75	21.49	877	627
PELICAN/AW	242	13.46	18x4.14	1x4.14	0.1164	51	20.7	755	615
LARK/AW	201	46.88	30x2.92	7x2.92	0.1335	87	20.44	869	574
IBLS/AW	201	32.73	26x3.14	7x2.44	0.1359	70	19.88	774	564
BRANT/AW	201	26.13	24x3.27	7x2.18	0.1373	62	19.62	731	559
CHICKADEE/AW	201	11.16	18x3.77	1x3.77	0.1404	43	18.85	628	546
ORIOLE/AW	170	39.78	30x2.69	7x2.69	0.1573	75	18.83	737	517
LINNET/AW	170	27.83	26x2.89	7x2.25	0.1604	60	18.31	655	507
MERLIN/AW	170	9.46	18x3.47	1x3.47	0.1657	38	17.35	531	491
OSTRICH/AW	152	24.71	26x2.73	7x2.12	0.1801	54	17.28	583	472

The above data is approximate and subjected to manufacturing tolerance
Other types can be provided on specific request.

» Cont'd

Note:

Guideline values of current carrying capacity are valid up to 60 Hz, assuming an ambient temperature of 35 °C, final temperature of 80 °C wind velocity of 0.6 m/sec, sun radiation of 1000 W/m², emissivity of 0.5, absorption factor of 0.5.

Aluminum Conductor Aluminum Clad Steel Reinforced (ACSR/AW)

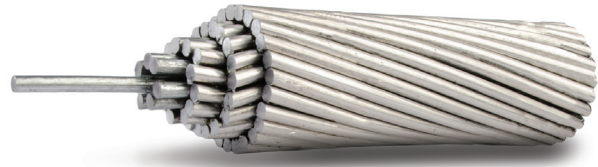

According to ASTM 549

Product Code	Cross Sectional Area		Number and Nominal Diameter of Wires		Max. DC. resistance at 20°C	Rated strength	Approx. overall diameter	Approx. Weight	Current carrying capacity
	Aluminum	Steel	Aluminum	Steel					
	mm ²		No x Ø (mm)						
PARTRIDGE/AW	135	21.99	26x2.57	7x2.00	0.2029	48	16.28	519	437
WAXWING/AW	135	7.5	18x3.09	1x3.09	0.209	30	15.45	421	424
4/0 PENGUIN/AW	107	17.87	6x4.77	1x4.77	0.2525	34	14.31	412	352
COCHIN/AW	107	62.44	12x3.37	7x3.37	0.2252	88	16.85	710	391
BRAHMA/AW	103	91.78	16x2.86	19x2.48	0.2157	120	18.12	894	407
DORKING/AW	96.7	56.3	12x3.20	7x3.20	0.2498	81	16	641	366
DOTTEREL/AW	89.6	52.15	12x3.08	7x3.08	0.2696	75	15.4	594	349
3/0 PIGEON/AW	85	14.19	6x4.25	1x4.25	0.318	28	12.75	326	304
GUINEA/AW	80.6	46.88	12x2.92	7x2.92	0.3000	68	14.6	534	326
LEGHORN/AW	68.2	39.78	12x2.69	7x2.69	0.3535	58	13.45	452	280
2/0 QUAIL/AW	67.4	11.22	6x3.78	1x3.78	0.4021	23	11.34	259	262
MINORCA/AW	56.1	32.73	12x2.44	7x2.44	0.4296	48	12.2	372	259
1/0 RAVEN /AW	53.5	8.92	6x3.37	1x3.37	0.506	19	10.11	205	227
PETREL/AW	51.6	30.1	12x2.34	7x2.34	0.4671	44	11.7	342	246
1 ROBIN/AW	42.4	7.07	6x3.00	1x3.00	0.6384	15	9	162	196
GROUSE/AW	40.5	14.12	8x2.54	1x4.24	0.634	21	9.32	205	198
2 SPARATE/AW	33.6	8.55	7x2.47	1x3.30	0.7851	16	8.24	149	191
2 SPARROW/AW	33.6	5.6	6x2.67	1x2.67	0.806	12	8.01	129	169

The above data is approximate and subjected to manufacturing tolerance
Other types can be provided on specific request.

Note:

Guideline values of current carrying capacity are valid up to 60 Hz, assuming an ambient temperature of 35 °C, final temperature of 80 °C wind velocity of 0.6 m/sec, sun radiation of 1000 W/m², emissivity of 0.5, absorption factor of 0.5.

Areal Bundled Cables (ABC):

Copper conductor insulated by XLPE



Description

This type of cables are made from Copper Conductor insulated by XLPE insulation and assembled together to form two (Duplex), three (Triplex), four (Quadruplex) or more conductors.

As per ICEA S-474-76, BS 7884 or according to customer specifications.

Application

They are used for secondary over head lines (in circuits not exceeding 600 volts phase to phase) on poles or as feeders to Residential premises.

Product Code	Phase		Max. DC. resistance at 20°C	Approx. overall diameter	Approx. Weight
	Cross Sectional Area	Insulation thickness			
	mm ²	mm			
Two Conductors (Duplex)					
CW1-T002-U10	10	1.1	1.829	12.6	220
CW1-T002-U11	16	1.1	1.154	14.6	334
CW1-T002-U12	25	1.1	0.7563	17	496
CW1-T002-U13	35	1.1	0.5337	19.4	695
CW1-T002-U14	50	1.5	0.3819	24	1010
CW1-T002-U15	70	1.5	0.2806	27	1320
CW1-T002-U16	95	1.5	0.198	31	1845
CW1-T002-U17	120	2	0.1578	36	2350
Three Conductors (Triplex)					
CW1-T003-U10	10	1.1	1.829	13.6	330
CW1-T003-U11	16	1.1	1.154	15.8	502
CW1-T003-U12	25	1.1	0.7563	18.4	744
CW1-T003-U13	35	1.1	0.5337	21	1040
CW1-T003-U14	50	1.5	0.3819	25.9	1515
CW1-T003-U15	70	1.5	0.2806	29.2	1980
CW1-T003-U16	95	1.5	0.198	33.5	2765
CW1-T003-U17	120	2	0.1578	38.9	3525
Four Conductors (Quadruplex)					
CW1-T004-U10	10	1.1	1.829	15.2	440
CW1-T004-U11	16	1.1	1.154	17.7	675
CW1-T004-U12	25	1.1	0.7563	20.6	995
CW1-T004-U13	35	1.1	0.5337	23.5	1390
CW1-T004-U14	50	1.5	0.3819	29	2025
CW1-T004-U15	70	1.5	0.2806	32.7	2645
CW1-T004-U16	95	1.5	0.198	37.5	3690
CW1-T004-U17	120	2	0.1578	43.6	4700

The above data is approximate and subjected to manufacturing tolerance

Areal Bundled Cables (ABC):

Aluminum conductor insulated by XLPE



Description

This type of cables are made from Aluminum Conductor insulated by XLPE insulation and assembled together to form two (Duplex), three (Triplex), four (Quadruplex) or more conductors.

As per ICEA S-474-76, BS EN 50182 or according to customer specifications.

Application

They are used for secondary over head lines (in circuits not exceeding 600 volts phase to phase) on poles or as feeders to Residential premises.

Product Code	Phase		Max. DC. resistance at 20°C	Approx. overall diameter	Approx. Weight
	Cross Sectional Area	Insulation thickness			
	mm ²	mm			
Two Conductors (Duplex)					
AW1-T002-U11	16	1.1	1.7986	14.6	135
AW1-T002-U12	25	1.1	1.1787	17	195
AW1-T002-U13	35	1.1	0.8317	19.4	265
AW1-T002-U14	50	1.5	0.5944	24	400
AW1-T002-U15	70	1.5	0.4367	27	445
AW1-T002-U16	95	1.5	0.3081	31	675
AW1-T002-U17	120	2	0.2456	36	885
Three Conductors (Triplex)					
AW1-T003-U11	16	1.1	1.7986	15.8	205
AW1-T003-U12	25	1.1	1.1787	18.4	300
AW1-T003-U13	35	1.1	0.8317	21	395
AW1-T003-U14	50	1.5	0.5944	25.9	600
AW1-T003-U15	70	1.5	0.4367	29.2	745
AW1-T003-U16	95	1.5	0.3081	33.5	1015
AW1-T003-U17	120	2	0.2456	38.9	1325
Four Conductors (Quadruplex)					
AW1-T004-U11	16	1.1	1.7986	17.7	275
AW1-T004-U12	25	1.1	1.1787	20.6	390
AW1-T004-U13	35	1.1	0.8317	23.5	535
AW1-T004-U14	50	1.5	0.5944	29	795
AW1-T004-U15	70	1.5	0.4367	32.7	995
AW1-T004-U16	95	1.5	0.3081	37.5	1350
AW1-T004-U17	120	2	0.2456	43.6	1765

The above data is approximate and subjected to manufacturing tolerance





High Temperature Low Sag (HTLS) Conductors

Overview:

"Elsewedy Cables proudly present the new section of High Temperature Low Sag (HTLS) conductors which will help our customers and utilities to optimize the efficiency of overhead lines.

Because of high cost of installation of new transmission lines, time involved and difficulty in acquiring tower sites-right of way, HTLS is the best solution for reconductoring existing lines to increase power flow and also for new lines to accommodate future contingencies and increased demand of power.

HTLS conductors consists of new developed Aluminum materials that are able to operate continuously at higher temperatures up to 150°C - 250°C, while materials used for traditional types of overhead conductors such as AAAC and ACSR are limited to maximum operating temperature of 80°C.

New materials for central core have been developed for HTLS conductors to limit the sag at high temperatures and improve mechanical properties of complete conductor (INVAR steel, Galfan steel, and polymer matrix composites)."

Product Types:

1. Aluminum Conductor Composite Core (ACCC)
2. Aluminum Conductor Steel Supported (ACSS/MA)
3. Aluminum Conductor Aluminum-Clad Steel Supported (ACSS/AW)
4. Thermal Resistant Aluminum Alloy Conductor Steel Reinforced (TACSR)
5. Thermal Resistant Aluminum Alloy Conductor Aluminum-Clad Steel Reinforced (TACSR/AW)
6. Super Thermal Resistant Aluminum Alloy Conductor Aluminum-Clad Invar Reinforced (STACIR/AW)

Table 1
Outer Layer(s) Material Types for High Temperature Low Sag Conductors

Definition	Unit	Outer Layer(s) Type				
		1350-O	AT1	AT2	AT3	AT4
		Fully Annealed Aluminum	Aluminum Zirconium Alloy (Al-Zr)			
			Thermal-Resistant Aluminum Alloy (TAL)	Extra High-Strength Thermal-Resistant Aluminum Alloy (Hi-TAL)	Super Thermal-Resistant Aluminum Alloy (STAL)	Extra Thermal-Resistant Aluminum Alloy (XTAL)
Standard		ASTM B609 EN 50540	IEC 62004			
Density at 20°C	g/cm ³	2.703	2.703	2.703	2.703	2.703
Minimum tensile strength	MPa	60 - 95	159 - 169	225 - 248	159 - 176	159 - 169
Coefficient of linear expansion	/°C	23 × 10 ⁻⁶	23 × 10 ⁻⁶	23 × 10 ⁻⁶	23 × 10 ⁻⁶	23 × 10 ⁻⁶
Maximum resistivity at 20°C	nΩ.m	27.899	28.735	31.347	28.735	29.726
Conductivity (IACS)	%	61.8	60	55	60	58
Allowable continuous operating temperature	°C	180 - 250	150	150	210	230

Table 2
High Temperature Low Sag Conductors Types

Central Core Type		Outer Layer(s) Type				
		1350-O Fully Annealed Aluminum	AT1 Thermal-Resistant Aluminum Alloy	AT2 Extra High-Strength Thermal-Resistant Aluminum Alloy	AT3 Super Thermal-Resistant Aluminum Alloy	AT4 Extra Thermal-Resistant Aluminum Alloy
Central Core Type	Carbon-Glass Fiber Composite Core	ACCC				
	Galvanized Steel Core	ACSS	TACSR	Hi-TACSR		
	Zinc-5% Aluminum Mischmetal Alloy-Coated Steel Core (Galfan)	ACSS/MA* 2)				
	Aluminum-Clad Steel Core	ACSS/AW	TACSR/AW	Hi-TACSR/AW		
	Galvanized Invar Core		TACIR 1)	Hi-TACIR 1)	STACIR 1)	XTACIR 1)
	Aluminum-Clad Invar Core		TACIR/AW 1)	Hi-TACIR/AW 1)	STACIR/AW	XTACIR/AW

Note:
All abovementioned conductor types can be offered with round wires or trapezoidal wires (TW), except the ACCC that shall be with trapezoidal wires only.
1) These types aren't commonly used.
2) There are different gards of Mischmetal Alloy-Coated Steel Core such as such as MA2,MA3,MA4,MA5.

Maximum Operating Temperature for Overhead Conductors

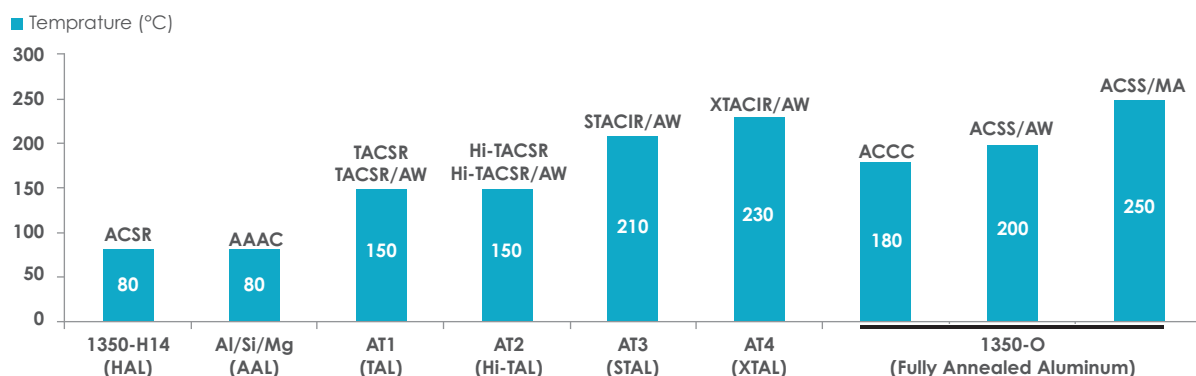

Aluminum Conductor Composite Core (ACCC)



Description

Aluminum Conductor Composite Core (ACCC) is a concentrically stranded conductor with one or more layers of trapezoidal shaped annealed 1350-O aluminum wires on a central core of light weight Carbon-Glass fiber composite.

Advantages

The ACCC Hybrid Carbon Composite Core is stronger and lighter than the traditional steel core.

ACCC is capable to carry twice the current of the traditional ACSR conductor as it's designed for continuous operating temperature up to 180°C, in addition to it's lighter core which allows to use about 30% more aluminum without increasing the total weight.

Usage of ACCC reduces line losses by 30 to 40% -under equal load conditions- compared to traditional ACSR conductors of the same diameter and weight.

Greater strength, effective self-damping, superior fatigue resistance and low coefficient of thermal expansion of ACCC reduce conductor sag under heavy electrical load conditions that lead to increased spans between fewer or shorter structures.

ACCC conductors have greater corrosion resistance than traditional ACSR.

Application

ACCC conductors are used for overhead distribution and transmission lines as they're especially useful in reconductoring applications requiring increased current with existing tensions and clearances, new line applications where structures can be economized due to reduced conductor sag, new line applications requiring high emergency loadings, and lines where vibration due to wind is a problem, also they can be used at corrosive and coastal environments due to their good corrosion resistance.

Code	Aluminum Cross Section Area	Minimum Number of Layers of Aluminum	Nominal Diameter		Approx. Weight of ACCC Conductor	Rated Tensile Strength	Max. DC Resistance at 20°C	Current Rating at 180°C ¹⁾
			Core	Conductor				
	mm ²		mm		kg/km	kN	Ohm/km	Amp
Helsinki	151	2	5.97	15.65	471	68.9	0.1862	765
Copenhagen	220	2	5.97	18.29	661	72.8	0.1272	971
Reykjavik	223	2	7.11	18.82	694	98.3	0.1256	986
Monte Carlo	229	2	10.54	20.78	799	201.2	0.123	1027
Glasgow	237	2	7.75	19.53	732	115	0.1184	1027
Casablanca	274	2	7.11	20.5	834	101.1	0.1024	1120
Oslo	314	2	8.76	22.4	981	147.8	0.0893	1234
Lisbon	316	2	7.11	21.79	948	103.5	0.0887	1227
Amsterdam	367	2	7.75	23.55	1101	122.4	0.0762	1355
Brussels	421	2	8.13	25.15	1265	135.7	0.0666	1479
Stockholm 2L	463	2	8.76	26.4	1395	156.2	0.0605	1576
Warsaw	508	2	8.76	27.72	1519	158.7	0.0553	1673
Dublin	525	2	9.53	28.14	1583	183.3	0.0534	1711
Hamburg	546	3	8.76	28.62	1627	160.9	0.0514	1752
Kolkata	544	3	9.53	28.62	1643	184	0.0517	1748
Milan	568	3	8.76	29.1	1686	162.1	0.0494	1797
Rome	593	3	9.53	29.89	1774	187.1	0.0474	1850
Vienna	629	3	8.76	30.42	1852	165.5	0.0445	1918
Budapest	668	3	9.53	31.5	1984	191.4	0.042	1996
Prague	691	3	8.76	31.77	2030	169	0.0407	2032
Mumbai	685	3	9.53	31.77	2035	192	0.041	2025
Munich	733	3	9.53	32.85	2170	195	0.0384	2113
London	759	3	9.78	33.4	2248	204.8	0.037	2164
Paris	814	3	8.76	34.16	2366	175.9	0.0345	2254
Antwerp	945	3	9.78	36.85	2760	215.2	0.0297	2483
Berlin (Madrid Ice)	1007	3	10.54	38.2	2949	245	0.0278	2594

General Notes (for all products):

* Guideline values of current carrying capacity are valid up to 60 Hz, assuming an ambient temperature of 40°C, wind velocity of 0.6 m/sec, sun radiation of 1033 W/m², emissivity of 0.5, absorption factor of 0.5

* Other sizes according to different standards or client specifications are available upon request

Aluminum Conductor Steel Supported (ACSS/MA)



Description

Aluminum Conductor Steel Supported (ACSS) consists of one or more layers of annealed aluminum 1350-O wires stranded over a central core of zinc-5% aluminum mischmetal alloy-coated steel wires that is designed to withstand most or all of the mechanical load on ACSS.

ACSS conductors are manufactured according to ASTM B 856, other standards could be offered.

Advantages

ACSS conductors are similar to traditional ACSR with some very important additional advantages. ACSS can operate continuously at high temperatures up to 250°C without damage.

ACSS sags less under emergency electrical loading than ACSR, it has self-damping properties and its final sags are not affected by long time creep of the aluminum.

Application

ACSS conductors are used for overhead distribution and transmission lines as they're especially useful in reconductoring applications requiring increased current with existing tensions and clearances, new line applications where structures can be economized due to reduced conductor sag, new line applications requiring high emergency loadings, and lines where vibration due to wind is a problem.

Code	Size	Construction No. x Wire Diameter		Cross Section Area		Nominal Outer Diameter	Approx. Weight			Rated Tensile Strength		Max. DC Resistance at 20°C	Current Rating at 200°C ⁽¹⁾	Current Rating at 250°C ⁽¹⁾
		Al	Steel	Total	Al		Total	Al	Steel	MA3 ⁽²⁾	MA5 ⁽²⁾			
	Kcmil	No. x mm		mm ²		mm	kg/km			kN		Ohm/km	Amp	Amp
PARTRIDGE	267	26X2.57	7X2.00	157	135	16.3	545	374	172	43.3	50.7	0.2072	780	876
JUNCO	267	30X2.40	7X2.40	167	136	16.8	624	377	247	57.8	68.0	0.2044	793	891
OSTRICH	300	26X2.73	7X2.12	177	152	17.3	615	422	193	48.5	56.9	0.1836	843	947
LINNET	336	26X2.89	7X2.25	198	171	18.3	690	473	217	54.3	64.1	0.1638	907	1020
ORIOLE	336	30X2.69	7X2.69	210	170	18.8	784	474	311	72.5	85.4	0.1627	918	1032
BRANT	398	24X3.27	7X2.18	228	202	19.6	763	558	204	53.8	62.7	0.1393	1004	1129
IBIS	398	26X3.14	7X2.44	234	201	19.9	813	558	256	63.2	73.8	0.1388	1010	1137
LARK	398	30X2.92	7X2.92	248	201	20.5	924	558	366	85.8	100.6	0.1381	1021	1151
FLICKER	477	24X3.58	7X2.39	273	242	21.5	915	669	245	63.2	73.6	0.1162	1128	1271
HAWK	477	26X3.44	7X2.67	281	242	21.8	976	670	306	76.1	88.4	0.1157	1136	1280
HEN	477	30X3.20	7X3.20	298	241	22.4	1110	670	440	101.0	118.6	0.1150	1149	1295
PARAKEET	556	24X3.87	7X2.58	319	282	23.2	1068	782	286	73.8	85.8	0.0995	1247	1407
DOVE	556	26X3.72	7X2.89	329	283	23.5	1142	783	359	88.5	103.5	0.0989	1256	1417
EAGLE	556	30X3.46	7X3.46	348	282	24.2	1298	783	514	117.9	138.7	0.0983	1271	1435
PEACOCK	605	24X4.03	7X2.69	346	306	24.2	1159	848	311	80.5	93.2	0.0917	1314	1485
SQUAB	605	26X3.87	7X3.01	356	306	24.5	1236	847	389	96.5	112.3	0.0914	1321	1493
TEAL	605	30X3.61	19X2.16	377	307	25.3	1398	853	545	130.3	154.3	0.0904	1342	1517
WOOD DUCK	605	30X3.61	7X3.61	379	307	25.3	1412	853	560	125.9	148.4	0.0903	1342	1518
ROOK	636	24X4.14	7X2.76	365	323	24.8	1222	895	327	84.5	98.2	0.0869	1359	1537
GROSBKAK	636	26X3.97	7X3.09	374	322	25.2	1302	892	410	99.6	116.2	0.0868	1367	1546
EGRET	636	30X3.70	19X2.22	396	323	25.9	1471	896	576	137.4	162.8	0.0861	1385	1565
SCOTER	636	30X3.70	7X3.70	398	323	25.9	1484	896	588	132.1	155.9	0.0860	1385	1566
FLAMINGO	666	24X4.23	7X2.82	381	337	25.4	1276	934	342	88.5	102.5	0.0832	1399	1580
GANNET	666	26X4.07	7X3.16	393	338	25.8	1366	937	429	104.1	121.6	0.0826	1411	1594
STILT	716	24X4.39	7X2.92	410	363	26.3	1373	1006	366	94.7	110.0	0.0773	1467	1658
STARLING	716	26X4.21	7X3.28	421	362	26.7	1465	1003	462	112.1	130.9	0.0772	1475	1668
REDWING	716	30X3.92	19X2.35	444	362	27.5	1651	1006	645	151.2	177.4	0.0767	1494	1690
CUCKOO	795	24X4.62	7X3.08	454	402	27.7	1522	1115	407	103.6	120.2	0.0698	1566	1774
DRAKE	795	26X4.44	7X3.45	468	403	28.1	1626	1115	511	124.5	144.9	0.0694	1577	1787
MALLARD	795	30X4.14	19X2.48	496	404	29.0	1840	1122	718	168.6	197.6	0.0687	1601	1815
MACAW	795	42X3.50	7X1.94	425	404	26.8	1281	1120	162	56.0	63.2	0.0703	1545	1749
TERN	795	45X3.38	7X2.25	432	404	27.0	1336	1119	217	67.6	77.4	0.0701	1550	1755

» Cont'd

Aluminum Conductor Steel Supported (ACSS/MA)

Code	Size	Construction No. x Wire Diameter		Cross Section Area		Nominal Outer Diameter	Approx. Weight			Rated Tensile Strength		Max. DC Resistance at 20°C	Current Rating at 200°C ¹⁾	Current Rating at 250°C ¹⁾
		Al	Steel	Total	Al		Total	Al	Steel	MA3 ²⁾	MA5 ²⁾			
	Kcmil		No. x mm		mm ²		kg/km			kN				
CONDOR	795	54X3.08	7X3.08	454	402	27.7	1522	1115	407	103.6	120.2	0.0698	1566	1774
RUDDY	900	45X3.59	7X2.40	487	456	28.7	1509	1262	247	75.6	86.4	0.0622	1675	1898
CANARY	900	54X3.28	7X3.28	515	456	29.5	1726	1264	462	117.4	136.3	0.0615	1699	1925
REDBIRD	954	24X5.06	7X3.38	545	483	30.4	1828	1337	491	124.5	144.6	0.0582	1763	1997
CANVASBACK	954	30X4.53	19X2.72	594	484	31.7	2207	1343	864	201.9	237.6	0.0574	1799	2039
RAIL	954	45X3.70	7X2.47	517	484	29.6	1603	1341	262	80.1	91.6	0.0585	1743	1973
TOWHEE	954	48X3.58	7X2.79	526	483	29.8	1673	1339	334	94.7	109.1	0.0584	1748	1979
CARDINAL	954	54X3.38	7X3.38	547	485	30.4	1833	1342	491	124.5	144.7	0.0579	1767	2001
SNOWBIRD	1034	42X3.99	7X2.21	552	525	30.6	1665	1455	210	72.9	82.3	0.0541	1832	2075
ORTOLAN	1034	45X3.85	7X2.57	560	524	30.8	1735	1451	284	86.7	99.2	0.0541	1829	2080
CURLEW	1034	54X3.51	7X3.51	590	523	31.6	1977	1448	529	134.8	156.1	0.0537	1849	2104
BLUEJAY	1113	45X4.00	7X2.66	604	565	32.0	1871	1567	304	93.9	106.5	0.0501	1922	2188
FINCH	1113	54X3.65	19X2.19	637	565	32.8	2133	1573	560	147.7	172.1	0.0500	1940	2209
BUNTING	1193	45X4.14	7X2.76	648	606	33.1	2005	1678	327	100.1	114.5	0.0467	2010	2280
GRACKLE	1193	54X3.77	19X2.27	680	603	34.0	2280	1678	602	157.9	184.6	0.0468	2026	2300
BITTERN	1272	45X4.27	7X2.85	689	644	34.2	2134	1785	349	106.8	122.0	0.0439	2095	2377
PHEASANT	1272	54X3.90	19X2.34	727	645	35.1	2435	1796	640	165.9	192.4	0.0438	2117	2404
DIPPER	1352	45X4.40	7X2.93	731	684	35.2	2264	1896	369	113.4	129.1	0.0414	2173	2473
MARTIN	1352	54X4.02	19X2.41	772	685	36.2	2587	1908	678	176.1	204.2	0.0412	2198	2503
BOBOLINK	1431	45X4.53	7X3.02	775	725	36.3	2401	2009	392	120.1	137.0	0.0390	2253	2572
PLOVER	1431	54X4.14	19X2.48	819	727	37.2	2742	2024	718	186.4	216.3	0.0388	2277	2601
NUTHATCH	1511	45X4.65	7X3.10	817	764	37.2	2530	2117	413	125.0	142.3	0.0371	2330	2655
PARROT	1511	54X4.25	19X2.55	863	766	38.2	2892	2133	759	196.6	228.5	0.0368	2357	2687
RATITE	1590	42X4.94	7X2.75	847	805	37.9	2555	2230	325	111.2	125.4	0.0353	2402	2731
LAPWING	1590	45X4.77	7X3.18	860	804	38.2	2662	2228	434	131.7	149.7	0.0352	2410	2741
FALCON	1590	54X4.36	19X2.62	909	806	39.2	3046	2245	802	207.3	241.1	0.0350	2438	2774

Notes:

- 1) ACSS/MA3: supported with high-strength Zinc-5% Aluminum-Mischmetal Alloy (Zn-5Al-MM) coated steel core.
ACSS/MA5: supported with ultra-high strength Zinc-5% Aluminum-Mischmetal Alloy (Zn-5Al-MM) coated steel core.
Different grades of zinc-5% aluminum mischmetal alloy-coated steel core specified in ASTM 856 (MA2,MA4) are available upon request.
- 2) ACSS conductor also with different grades of galvanized Steel core can be offered upon request.

Aluminum Conductor Aluminum-Clad Steel Supported (ACSS/AW)



Description

Aluminum Conductor Aluminum-Clad Steel Supported (ACSS/AW) consists of one or more layers of annealed aluminum 1350-O wires stranded over a central core of aluminum clad steel wires that is designed to withstand most or all of the mechanical load on ACSS/AW.

ACSS/AW conductors are manufactured according to ASTM B 856, other standards could be offered.

Advantages

ACSS/AW can operate continuously at high temperatures up to 200°C without damage. The aluminum clad steel core, which consists of a thick layer of aluminum (approx. 10% of the nominal wire radius) over steel, gives ACSS/AW conductors the advantages of standard ACSS along with light weight and good conductivity of aluminum with the high tensile strength and ruggedness of steel.

Application

ACSS/AW conductors are used for overhead distribution and transmission lines as they're especially useful in reconductoring applications requiring increased current with existing tensions and clearances, new line applications where structures can be economized due to reduced conductor sag, new line applications requiring high emergency loadings, and lines where vibration due to wind is a problem.

ACSS/AW offers strength characteristics similar to ACSS, along with slightly greater ampacity and resistance to corrosion due to aluminum-cladding of the steel core wires.

Code	Size	Construction No. x Wire Diameter		Cross Section Area		Nominal Outer Diameter	Approx. Weight			Rated Tensile Strength	Max. DC Resistance at 20°C	Current Rating at 200°C ⁽¹⁾
		Al	ACS	Total	Al		Total	Al	ACS			
		No. x mm		mm ²			kg/km			AW2 ⁽²⁾		
PARTRIDGE	267	26x2.57	7x2.00	157	135	16.3	519	374	146	37.0	0.2010	792
JUNCO	267	30x2.40	7x2.40	167	136	16.8	586	377	210	50.0	0.1958	810
OSTRICH	300	26x2.73	7x2.12	177	152	17.3	585	422	163	42.0	0.1782	856
LINNET	336	26x2.89	7x2.25	198	171	18.3	657	473	184	47.0	0.1590	921
ORIOLE	336	30x2.69	7x2.69	210	170	18.8	737	474	263	63.0	0.1559	938
BRANT	398	24x3.27	7x2.18	228	202	19.6	731	558	173	46.0	0.1360	1015
IBIS	398	26x3.14	7x2.44	234	201	19.9	774	558	217	55.0	0.1347	1025
LARK	398	30x2.92	7x2.92	248	201	20.5	868	558	310	74.0	0.1323	1043
FLICKER	477	24x3.58	7x2.39	273	242	21.5	877	669	208	56.0	0.1134	1142
HAWK	477	26x3.44	7x2.67	281	242	21.8	929	670	259	66.0	0.1122	1153
HEN	477	30x3.20	7x3.20	298	241	22.4	1043	670	372	89.0	0.1102	1174
PARAKEET	556	24x3.87	7x2.58	319	282	23.2	1024	782	242	65.0	0.0971	1263
DOVE	556	26x3.72	7x2.89	329	283	23.5	1087	783	304	78.0	0.0960	1274
EAGLE	556	30x3.46	7x3.46	348	282	24.2	1219	783	435	102.0	0.0942	1297
PEACOCK	605	24x4.03	7x2.69	346	306	24.2	1111	848	263	71.0	0.0895	1330
SQUAB	605	26x3.87	7x3.01	356	306	24.5	1177	847	330	85.0	0.0887	1342
TEAL	605	30x3.61	19x2.16	377	307	25.3	1314	853	462	111.0	0.0867	1370
WOOD DUCK	605	30x3.61	7x3.61	379	307	25.3	1327	853	474	109.0	0.0866	1372
ROOK	636	24x4.14	7x2.76	365	323	24.8	1172	895	277	74.0	0.0848	1376
GROSBKAK	636	26x3.97	7x3.09	374	322	25.2	1239	892	347	89.0	0.0842	1388
EGRET	636	30x3.70	19x2.22	396	323	25.9	1383	896	488	117.0	0.0825	1414
SCOTER	636	30x3.70	7x3.70	398	323	25.9	1394	896	498	112.0	0.0824	1416
FLAMINGO	666	24x4.23	7x2.82	381	337	25.4	1224	934	289	78.0	0.0813	1416
GANNET	666	26x4.07	7x3.16	393	338	25.8	1300	937	363	93.0	0.0802	1433
STILT	716	24x4.39	7x2.92	410	363	26.3	1317	1006	310	84.0	0.0755	1485
STARLING	716	26x4.21	7x3.28	421	362	26.7	1394	1003	391	98.0	0.0749	1498
REDWING	716	30x3.92	19x2.35	444	362	27.5	1552	1006	546	131.0	0.0736	1526
CUCKOO	795	24x4.62	7x3.08	454	402	27.7	1460	1115	345	93.0	0.0681	1586
DRAKE	795	26x4.44	7x3.45	468	403	28.1	1548	1115	433	109.0	0.0674	1602
MALLARD	795	30x4.14	19x2.48	496	404	29.0	1730	1122	608	146.0	0.0659	1634

» Cont'd

Aluminum Conductor Aluminum-Clad Steel Supported (ACSS/AW)

Code	Size	Construction No. x Wire Diameter		Cross Section Area		Nominal Outer Diameter	Approx. Weight			Rated Tensile Strength	Max. DC Resistance at 20°C	Current Rating at 200°C ¹⁾
		Al	ACS	Total	Al		Total	Al	ACS	AW2 ²⁾		
	Kcmil	No. x mm		mm ²		mm	kg/km			kN	Ohm/km	Amp
MACAW	795	42x3.50	7x1.94	425	404	26.8	1256	1120	137	51.0	0.0696	1552
TERN	795	45x3.38	7x2.25	432	404	27.0	1303	1119	184	60.0	0.0692	1560
CONDOR	795	54x3.08	7x3.08	454	402	27.7	1460	1115	345	93.0	0.0681	1586
RUDDY	900	45x3.59	7x2.40	487	456	28.7	1472	1262	210	68.0	0.0613	1687
CANARY	900	54x3.28	7x3.28	515	456	29.5	1656	1264	391	103.0	0.0601	1720
REDBIRD	954	24x5.06	7x3.38	545	483	30.4	1753	1337	416	109.0	0.0568	1785
CANVASBACK	954	30x4.53	19x2.72	594	484	31.7	2075	1343	732	175.0	0.0551	1837
RAIL	954	45x3.70	7x2.47	517	484	29.6	1562	1341	222	72.0	0.0578	1755
TOWHEE	954	48x3.58	7x2.79	526	483	29.8	1622	1339	283	85.0	0.0575	1763
CARDINAL	954	54x3.38	7x3.38	547	485	30.4	1758	1342	416	109.0	0.0566	1788
SNOWBIRD	1034	42x3.99	7x2.21	552	525	30.6	1633	1455	178	66.0	0.0535	1834
ORTOLAN	1034	45x3.85	7x2.57	560	524	30.8	1692	1451	240	78.0	0.0533	1841
CURLEW	1034	54x3.51	7x3.51	590	523	31.6	1896	1448	448	116.0	0.0524	1872
BLUEJAY	1113	45x4.00	7x2.66	604	565	32.0	1824	1567	257	84.0	0.0494	1935
FINCH	1113	54x3.65	19x2.19	637	565	32.8	2048	1573	474	128.0	0.0488	1964
BUNTING	1193	45x4.14	7x2.76	648	606	33.1	1955	1678	277	90.0	0.0461	2024
GRACKLE	1193	54x3.77	19x2.27	680	603	34.0	2188	1678	510	137.0	0.0457	2051
BITTERN	1272	45x4.27	7x2.85	689	644	34.2	2081	1785	295	96.0	0.0434	2109
PHEASANT	1272	54x3.90	19x2.34	727	645	35.1	2338	1796	542	146.0	0.0427	2137
DIPPER	1352	45x4.40	7x2.93	731	684	35.2	2208	1896	312	102.0	0.0408	2187
MARTIN	1352	54x4.02	19x2.41	772	685	36.2	2483	1908	575	155.0	0.0402	2224
BOBOLINK	1431	45x4.53	7x3.02	775	725	36.3	2341	2009	332	108.0	0.0385	2268
PLOVER	1431	54x4.14	19x2.48	819	727	37.2	2632	2024	608	164.0	0.0379	2305
NUTHATCH	1511	45x4.65	7x3.10	817	764	37.2	2467	2117	350	114.0	0.0366	2346
PARROT	1511	54x4.25	19x2.55	863	766	38.2	2776	2133	643	173.0	0.0360	2386
RATITE	1590	42x4.94	7x2.75	847	805	37.9	2505	2230	275	101.0	0.0349	2414
LAPWING	1590	45x4.77	7x3.18	860	804	38.2	2596	2228	368	120.0	0.0348	2427
FALCON	1590	54x4.36	19x2.62	909	806	39.2	2924	2245	679	183.0	0.0342	2468

Notes:

ACSS/AW2: supported with regular strength aluminum-clad core wire.

Different grades of Aluminum-Clad Steel core (High strength AW3) are available upon request.

Thermal Resistant Aluminum Alloy Conductor Steel Reinforced (TACSR)



Description

Thermal Resistant Aluminum Alloy Conductor Steel Reinforced (TACSR) consists of one or more layers of thermal resistant aluminium zirconium alloy (AT1) wires stranded over a central core of zinc coated steel wire(s).

TACSR conductors are manufactured according to IEC 62004 and IEC 60888 and generally according to IEC 61089, other standards could be offered.

Advantages

TACSR conductors are able to carry load current higher than traditional ACSR conductors about 150 % as they are designed for continuous operating temperature up to 150°C.

TACSR conductors have same installation technique of ACSR.

Application

TACSR conductors are used for overhead distribution and transmission lines as they're especially useful in new line applications requiring increased current.

Size	Construction No. x Wire Diameter		Cross Section Area		Nominal Outer Diameter	Approx. Weight			Rated Tensile Strength	Max. DC Resistance at 20°C	Modulus of Elasticity	Coefficient of Linear Expansion	Current Rating at 150°C (1)
	TAL	Steel	Total	TAL		Total	TAL	Steel					
mm ²	No. x mm		mm ²		mm	kg/km			kN	Ohm/km	kgf/mm ²	x10 ⁻⁶ /°C	Amp
58	6x3.5	1x3.5	67	58	10.5	233	158	75	19.9	0.5053	8400	18.9	378
80	6x4.2	1x4.2	97	83	12.6	336	228	108	28.5	0.3509	8400	18.9	476
95	6x4.5	1x4.5	111	95	13.5	386	262	124	32.7	0.3057	8400	18.9	520
120	30x2.3	7x2.3	154	125	16.1	572	345	227	54.2	0.2357	9080	18	621
160	30x2.6	7x2.6	196	159	18.2	731	440	291	69.3	0.1845	9080	18	726
200	30x2.9	7x2.9	244	198	20.3	909	548	362	85.6	0.1483	9080	18	834
240	30x3.2	7x3.2	298	241	22.4	1107	667	440	101.0	0.1218	9080	18	946
330	26x4.0	7x3.1	380	327	25.3	1316	902	413	110.1	0.0899	8360	19	1138
410	26x4.5	7x3.5	481	414	28.5	1669	1142	527	139.8	0.0710	8360	19	1323
480	45x3.7	7x2.47	517	484	29.6	1599	1337	262	116.6	0.0607	7250	20.8	1445
520	54x3.5	7x3.5	587	520	31.5	1963	1437	527	158.2	0.0566	7990	19.5	1523
610	54x3.8	7x3.8	692	612	34.2	2314	1694	621	186.5	0.0480	7990	19.5	1690
680	54x4.0	7x4.0	767	679	36.0	2565	1877	688	204.7	0.0433	7990	19.5	1801
680	45x4.4	7x2.9	730	684	35.1	2252	1891	362	161.5	0.0429	7250	20.8	1794

Notes:

Different grades of Galvanized steel core (high strength, extra high strength) are available upon request.

Thermal Resistant Aluminum Alloy Conductor Aluminum-Clad Steel Reinforced (TACSR/AW)



Description

Thermal Resistant Aluminum Alloy Conductor Aluminum-Clad Steel Reinforced (TACSR/AW) consists of one or more layers of thermal resistant aluminum zirconium alloy (AT1) wires stranded over a central core of stranded aluminum-clad steel (20SA Type A) wire(s) .

TACSR/AW conductors are manufactured according to IEC 62004 and IEC 61232 and generally according to IEC 61089, other standards could be offered.

Advantages

TACSR/AW conductors are able to carry load current higher than traditional ACSR conductors as they are designed for continuous operating temperature up to 150°C, additionally they have increased corrosion resistance and lower electrical resistance & lower mass than TACSR.

TACSR/AW conductors have same installation technique of ACSR.

Application

TACSR/AW conductors are used for overhead distribution and transmission lines as they're especially useful in new line applications requiring increased current, also they can be used at corrosive and coastal environments due to their good corrosion resistance.

Size	Construction No. x Wire Diameter		Cross Section Area		Nominal Outer Diameter	Approx. Weight			Rated Tensile Strength	Max. DC Resistance at 20°C	Modulus of Elasticity	Coefficient of Linear Expansion	Current Rating at 150°C (1)
	TAL	Steel	Total	TAL		Total	TAL	Steel					
mm ²	No. x mm		mm ²		mm	kg/km			kN	Ohm/km	kgf/mm ²	x10 ⁻⁶ /°C	Amp
120	30x2.3	7x2.3	154	125	16.1	537	345	193	56.0	0.2182	8100	19.2	646
160	30x2.6	7x2.6	196	159	18.2	686	440	246	71.5	0.1707	8100	19.2	755
200	30x2.9	7x2.9	244	198	20.3	854	548	306	88.4	0.1372	8100	19.2	867
210	30x3.2	7x3.2	298	241	22.4	1040	667	373	106.6	0.1127	8100	19.2	983
330	26x4.0	7x3.1	380	327	25.3	1252	902	350	115.4	0.0851	7620	20	1168
410	26x4.5	7x3.5	481	414	28.5	1588	1142	446	142.5	0.0672	7630	20	1357
480	45x3.7	7x2.47	517	484	29.6	1559	1337	222	118.6	0.0593	6910	21.5	1454
520	54x3.5	7x3.5	587	520	31.5	1883	1437	446	160.9	0.0542	7390	20.4	1549
610	54x3.8	7x3.8	692	612	34.2	2220	1694	526	186.5	0.0459	7330	20.4	1718
680	45x4.4	7x2.9	730	684	35.1	2197	1891	306	164.3	0.0420	6900	21.5	1807

Notes:

Different grades of Aluminum-Clad Steel core (high strength) are available upon request.

Super Thermal Resistant Aluminum Alloy Conductor Aluminum-Clad Invar Reinforced (STACIR/AW)



Description

Super Thermal Resistant Aluminum Alloy Conductor Aluminum-Clad Invar Reinforced (STACIR/AW) consists of one or more layers of super thermal resistant aluminium zirconium alloy (AT3) wires stranded over a central core of stranded aluminum-clad invar wires.

Invar: Special Fe/Ni alloy with very low coefficient of linear expansion.

STACIR/AW conductors are manufactured according to IEC 62004 and generally according to IEC 61089 and IEC 61232, other standards could be offered.

Advantages

STACIR/AW conductors are able to carry load current up to double than traditional ACSR conductors as they are designed for continuous operating temperature up to 210°C.

Beyond Knee point STACIR/AW conductor experiences a sag increase due to the expansion of Invar core alone (extremely low value $\leq 3.7 \times 10^{-6} / ^\circ\text{C}$) which control sag at high operating temperatures.

STACIR/AW conductors have same installation technique of ACSR, additionally they have increased corrosion resistance.

Application

STACIR/AW conductors are used for overhead distribution and transmission lines as they're especially useful in replacing existing conductors for line applications requiring increased current, also they can be used at corrosive and coastal environments due to their good corrosion resistance.

Size	Construction No. x Wire Diameter		Cross Section Area		Nominal Outer Diameter	Approx. Weight			Rated Tensile Strength	Max. DC Resistance at 20°C	Modulus of Elasticity	Coefficient of Linear Expansion	Current Rating at 210°C ¹⁾
	STAL	Invar	Total	STAL		Total	STAL	Invar					
mm ²	No. x mm		mm ²		mm	kg/km			kN	Ohm/km	kgf/mm ²	x10 ⁻⁶ /°C	Amp
135	30x2.38	7x2.38	165	133	16.7	591	369	222	55.9	0.2086	8040	16	804
160	30x2.60	7x2.60	196	159	18.2	706	440	265	65.4	0.1748	8040	16	902
200	30x2.90	7x2.90	244	198	20.3	878	548	330	80.7	0.1405	8040	16	1039
210	28x3.07	7x2.70	247	207	20.4	859	573	286	75.1	0.1355	7790	16.8	1058
220	30x3.05	7x3.05	270	219	21.4	971	606	365	87.3	0.1270	8040	16	1108
230	28x3.24	7x2.85	276	231	21.5	957	638	319	83.6	0.1217	7790	16.8	1134
238	40x2.75	7x4.20	335	238	23.6	1362	656	706	136.4	0.1129	8970	13.3	1212
240	30x3.20	7x3.20	298	241	22.4	1069	667	402	96.1	0.1154	8040	16	1179
255	26x3.54	7x2.75	297	256	22.4	1004	707	297	84.5	0.1105	7580	17.5	1205
255	36x3.00	7x3.99	342	254	24.0	1329	704	625	128.0	0.1069	8650	14.2	1251
290	28x3.64	7x3.20	348	291	24.2	1207	805	402	104.2	0.0964	7790	16.8	1320
300	26x3.85	7x3.00	352	303	24.4	1189	836	353	100.2	0.0934	7580	17.5	1343
330	26x4.00	7x3.10	380	327	25.3	1279	902	377	106.4	0.0865	7580	17.5	1410
340	28x3.92	7x3.45	403	338	26.0	1401	934	467	121.0	0.0831	7790	16.8	1452
345	26x4.11	7x3.20	401	345	26.0	1355	953	402	112.9	0.0819	7580	17.5	1462
410	26x4.50	7x3.50	481	414	28.5	1623	1142	481	135.1	0.0684	7580	17.5	1643
480 (Rail)	45x3.70	7x2.47	517	484	29.6	1576	1337	239	114.3	0.0597	6900	20.2	1776

Notes:

Galvanized invar core is available upon request.





Low Voltage Cables

**Operating Voltage
(up to 1.8/3 kV)**

Cable Construction

1. Conductor

Copper or Aluminium conductors, solid, stranded or flexible with round or sectoral shaped conductors.

2. Insulation

An extruded layer of PVC or XLPE is applied over the conductor. PVC insulated cables are suitable for maximum conductor operating temperature of 70°C or 85°C and 90°C for XLPE.

3. Assembly

In case of multicore cables' cores are assembled together using non hygroscopic filler (if needed) to fill space between cores, wrapped with suitable binder tape to form a round cable.

4. Bedding

In case of armoured cables an extruded layer of PVC or other material is applied as bedding.

5. Armouring

- Steel Tape: Double layers of steel tapes are applied helically with gap.
- Steel Wire: Galvanized steel wires are applied helically.

6. Sheath

An extruded layer of PVC is applied as an outer sheath, or according to the client special requirements.

Option

Lead Sheath: Upon request a layer of lead is extruded over the bedding layer.

Armouring of Single Core Cable

- Armouring by non-magnetic material either Aluminium Tape or Aluminium Wire armouring to reduce the magnetic losses.
- If it is required for single core cable to be armoured by steel wire armouring, the magnetic circuit around the single core cable should be interrupted by inserting insulated copper wires between the steel wires.

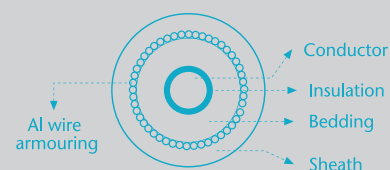
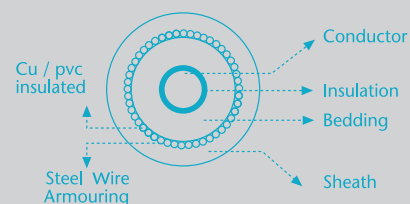

Armouring of Single Core Cable
Figure

450/750 V Indoor wires

Single Core Cables with Stranded Copper Conductors and PVC Insulated





Description

- Soft annealed stranded Copper conductors insulated with PVC compound rated 70 °C or 90 °C according to IEC 60227 & BS EN 50525-2-31.

Application

- For indoor fixed installations in dry locations, laid in conduits, as well as in steel support brackets.

Product - code	Nominal Cross Sectional Area	Max. Conductor Resistance		Current Rating in Air		Approx. Overall Diameter	Approx. Weight
		DC at 20 °C	AC at 70 °C	Free 	In Pipes 		
	mm ²	Ω/Km	Ω/Km	A	A	mm	Kg/Km
CPD-S001-U04	1.5 RE	12.1	14.6	20	15	2.8	20
CPD-T001-U04	1.5 RM	12.1	14.6	20	15	3	21
CPD-S001-U05	2 RE	9.15	10.9	22	17	3.2	27
CPD-T001-U05	2 RM	9.15	10.9	22	17	3.4	28
CPD-S001-U06	2.5 RE	7.41	8.89	28	22	3.4	31
CPD-T001-U06	2.5 RM	7.41	8.89	28	22	3.6	33
CPD-S001-U07	3 RE	6.1	7.41	31	24	3.6	36
CPD-T001-U07	3 RM	6.1	7.41	31	24	3.8	39
CPD-S001-U08	4 RE	4.61	5.51	37	26	3.9	46
CPD-T001-U08	4 RM	4.61	5.51	37	26	4.1	49
CPD-S001-U09	6 RE	3.08	3.68	46	33	4.4	66
CPD-T001-U09	6 RM	3.08	3.68	46	33	4.7	70
CPD-T001-U10	10 RM	1.83	2.17	66	47	5.8	109
CPD-T001-U11	16 RM	1.15	1.37	87	62	6.8	166
CPD-T001-U12	25 RM	0.727	0.8702	120	82	8.2	260
CPD-T001-U13	35 RM	0.524	0.6274	150	100	9.3	345
CPD-T001-U14	50 RM	0.387	0.4637	186	123	11	470
CPD-T001-U15	70 RM	0.268	0.3216	238	153	12.6	660
CPD-T001-U16	95 RM	0.193	0.2323	296	190	14.5	915
CPD-T001-U17	120 RM	0.153	0.1848	346	220	15.9	1145
CPD-T001-U18	150 RM	0.124	0.1505	400	252	17.7	1415
CPD-T001-U19	185 RM	0.0991	0.1212	466	289	19.8	1765
CPD-T001-U20	240 RM	0.0754	0.0937	561	346	22.6	2305
CPD-T001-U30	300 RM	0.0601	0.0763	655	393	25.4	2885
CPD-T001-U40	400 RM	0.047	0.0617	768	456	28.4	3705
CPD-T001-U50	500 RM	0.0366	0.0506	903	526	32.2	4760
CPD-T001-U60	630 RM	0.0283	0.0422	1054	605	35.7	6010
CPD-T001-U70	800 RM	0.0221	0.0363	1221	680	40	7825

The above data is approximate and subjected to manufacturing tolerance.

re : round, Solid
rm : round, Stranded

Single Core Cables with Flexible Copper Conductors and PVC Insulated





Description

- Soft annealed Copper fine wires, bunched together in subunits or stranded bunched groups into a main units, which forms the flexible conductor. Insulated with soft PVC 70 °C or 90 °C Compound.
- Cables are produced according to IEC 60227 or BS EN 50525-2-31, CEI-UNEL 35716.

Application

- For indoor fixed installations in dry locations, where particular flexibility is required. For electrical panels connection or for electrical apparatus they can be laid in groups around steel sheets.

Product - code	Nominal Cross Sectional Area	Maximum Diameter of Wires	Max. Conductor Resistance		Current Rating in Air		Approx. Overall Diameter	Approx. Weight
			DC at 20 °C	AC at 70 °C	Free 	In Pipes 		
	mm ²	mm	Ω/Km	Ω/Km	A	A	mm	Kg/Km
CPD-F001-U04	1.5	0.26	13.3	15.9	20	15	3	20
CPD-F001-U06	2.5	0.26	7.98	9.56	28	22	3.7	31
CPD-F001-U08	4	0.31	4.95	5.93	37	26	4.2	44
CPD-F001-U09	6	0.31	3.3	3.95	46	33	4.7	62
CPD-F001-U10	10	0.41	1.91	2.29	66	47	6.2	108
CPD-F001-U11	16	0.41	1.21	1.45	87	62	7.2	162
CPD-F001-U12	25	0.41	0.78	0.9336	124	83	9.5	260
CPD-F001-U13	35	0.41	0.554	0.6633	157	103	11	355
CPD-F001-U14	50	0.41	0.386	0.4625	198	128	12.6	495
CPD-F001-U15	70	0.51	0.272	0.3265	252	161	14.6	685
CPD-F001-U16	95	0.51	0.206	0.2478	308	195	17	915
CPD-F001-U17	120	0.51	0.161	0.1944	365	228	18.9	1150
CPD-F001-U18	150	0.51	0.129	0.1565	426	265	21.2	1440
CPD-F001-U19	185	0.51	0.106	0.1295	487	300	23.4	1750
CPD-F001-U20	240	0.51	0.0801	0.0993	590	359	26.9	2305
CPD-F001-U30	300	0.51	0.0641	0.081	681	407	29.6	2870
CPD-F001-U40	400	0.51	0.0486	0.0638	821	480	34	3970
CPD-F001-U50	500	0.61	0.0384	0.0528	961	555	38.7	5010
CPD-F001-U60	630	0.61	0.0287	0.043	1140	644	43	6500

The above data is approximate and subjected to manufacturing tolerance.

0.6/1 (1.2) KV Single Core Unarmoured Cables

Single Core Cables, with Stranded Circular Copper Conductors, PVC Insulated and PVC Sheathed



Description

- Soft annealed stranded Copper conductor. Insulated with PVC compound rated 70 °C and sheathed with PVC Compound layer.
- Cables are produced according to IEC 60502, HD 603-3A , HD 603-3G.

Application

- For outdoor and indoor installations in damp and wet locations. They are normally used for power distribution in urban networks, industrial plants, as well as in thermopower and hydropower stations.

1 Core - Cu/PVC/PVC

Product Code	Nominal Cross sectional area	Maximum Conductor Resistance		Current Rating						Approx. Overall Diameter	Approx. Weight
		DC at 20 °C	AC at 70 °C	Laid in ground			Laid in free air (Shaded)				
				Flat	Trefoil	Duct	Flat Separated	Flat Touched	Trefoil Touched		
				⊙⊙⊙	⊙ ⊙ ⊙	⊙ ⊙ ⊙	⊙⊙⊙	⊙⊙⊙	⊙ ⊙ ⊙		
mm ²	Ω/Km	Ω/Km	A	A	A	A	A	A	mm	Kg/Km	
CP1-T101-U08	4	4.61	5.51	53	53	38	50	37	35	7.1	87
CP1-T101-U09	6	3.08	3.68	65	66	47	65	48	46	7.6	113
CP1-T101-U10	10	1.83	2.17	88	89	62	89	9	62	8.3	154
CP1-T101-U11	16	1.15	1.37	113	113	77	108	85	79	9.3	216
CP1-T101-U12	25	0.727	0.8701	143	144	101	143	112	109	10.6	320
CP1-T101-U13	35	0.524	0.6273	171	173	123	176	138	134	11.7	410
CP1-T101-U14	50	0.387	0.4635	203	205	148	214	170	165	13.4	545
CP1-T101-U15	70	0.268	0.3214	248	252	183	271	215	209	15	745
CP1-T101-U16	95	0.193	0.232	296	301	224	332	267	259	17.1	1020
CP1-T101-U17	120	0.153	0.1845	337	342	255	386	310	301	18.5	1260
CP1-T101-U18	150	0.124	0.1501	378	383	292	442	357	347	20.5	1550
CP1-T101-U19	185	0.0991	0.1207	426	433	333	510	415	402	22.8	1925
CP1-T101-U20	240	0.0754	0.0931	494	501	393	608	496	481	25.8	2500
CP1-T101-U30	300	0.0601	0.0755	556	565	450	704	575	558	28.8	3110
CP1-T101-U40	400	0.047	0.0608	629	639	516	819	669	648	32	3975
CP1-T101-U50	500	0.0366	0.0495	709	721	594	957	777	753	36	5080
CP1-T101-U60	630	0.0283	0.041	792	807	672	1113	893	864	39.7	6385
CP1-T101-U70	800	0.0221	0.035	874	891	753	1284	1014	982	44.2	8260
CP1-T101-U80	1000	0.0176	0.0308	956	975	845	1478	1154	1116	51.7	10345

The above data is approximate and subjected to manufacturing tolerance.



0.6/1 (1.2) KV Single Core Unarmoured Cables

Single Core Cables, with Stranded Circular Aluminium Conductors, PVC Insulated and PVC Sheathed



Description

- Soft annealed stranded Aluminum conductor. Insulated with PVC compound rated 70 °C and sheathed with PVC Compound layer.
- Cables are produced according to IEC 60502, HD 603-3A , HD 603-3G.

Application

- For outdoor and indoor installations in damp and wet locations. They are normally used for power distribution in urban networks, industrial plants, as well as in thermopower and hydropower stations.

1 Core - AL/PVC/PVC

Product Code	Nominal Cross sectional area	Maximum Conductor Resistance		Current Rating						Approx. Overall Diameter	Approx. Weight
		DC at 20 °C	AC at 70 °C	Laid in ground			Laid in free air (Shaded)				
				Flat	Trefoil	Duct	Flat Separated	Flat Touched	Trefoil Touched		
mm ²	Ω/Km	Ω/Km	A	A	A	A	A	A	mm	Kg/Km	
AP1-T101-U11	16	1.91	2.2949	86	87	60	83	65	63	9.1	120
AP1-T101-U12	25	1.2	1.4419	111	112	79	111	87	85	10.6	170
AP1-T101-U13	35	0.868	1.0431	133	134	95	136	107	104	11.7	210
AP1-T101-U14	50	0.641	0.7704	157	159	115	166	132	128	13.4	265
AP1-T101-U15	70	0.443	0.5327	193	195	142	210	167	162	15	340
AP1-T101-U16	95	0.32	0.3851	230	233	174	258	207	201	17.1	445
AP1-T101-U17	120	0.253	0.3048	262	266	198	300	241	234	18.5	535
AP1-T101-U18	150	0.206	0.2485	294	298	227	343	278	269	20.5	655
AP1-T101-U19	185	0.164	0.1984	333	338	260	397	324	314	22.8	810
AP1-T101-U20	240	0.125	0.1519	386	392	307	473	388	376	25.7	1035
AP1-T101-U30	300	0.1	0.1224	437	444	353	548	451	438	28.7	1285
AP1-T101-U40	400	0.0778	0.0964	499	508	410	644	531	515	32	1615
AP1-T101-U50	500	0.0605	0.0764	570	580	478	757	625	605	35.9	2015
AP1-T101-U60	630	0.0469	0.0612	648	660	550	889	730	707	39.6	2515
AP1-T101-U70	800	0.0367	0.0503	730	744	630	1045	850	822	44.6	3170
AP1-T101-U80	1000	0.0291	0.0425	814	830	719	1219	982	950	51.7	3950

The above data is approximate and subjected to manufacturing tolerance.

0.6/1 (1.2) KV Single Core ATA cables

Single Core Cables, With Stranded Copper Conductors, PVC insulation, Aluminum Tape Armoured, and PVC Sheathed.



Description

- Soft annealed copper conductor, insulated with PVC compound rated 70 °C, Aluminum Tape Armoured and sheathed with PVC compound layer.
- Cables are produced according to IEC 60502 .

Application

- For outdoor and indoor installation in damp and wet locations where mechanical damages are expected to occur.

1 Core - Cu/PVC/ATA/PVC

Product Code	Nominal Cross sectional area	Maximum Conductor Resistance		Current Rating						Approx. Overall Diameter	Approx. Weight
		DC at 20 °C	AC at 70 °C	Laid in ground			Laid in free air (Shaded)				
				Flat	Trefoil	Duct	Flat Separated	Flat Touched	Trefoil Touched		
				⊙⊙⊙	⊙⊙⊙	⊙⊙⊙	⊙⊙⊙	⊙⊙⊙	⊙⊙⊙		
mm ²	Ω/Km	Ω/Km	A	A	A	A	A	A	mm	Kg/Km	
CP1-T101-B12	25	0.727	0.87	144	146	108	151	124	120	14.8	465
CP1-T101-B13	35	0.524	0.6272	173	175	131	185	151	147	15.9	565
CP1-T101-B14	50	0.387	0.4634	204	207	156	223	183	179	17.6	715
CP1-T101-B15	70	0.268	0.3212	249	253	192	280	230	224	19.2	935
CP1-T101-B16	95	0.193	0.2317	297	302	232	340	281	274	21.1	1220
CP1-T101-B17	120	0.153	0.1841	337	343	265	392	325	317	22.5	1470
CP1-T101-B18	150	0.124	0.1497	377	384	300	445	371	362	24.3	1770
CP1-T101-B19	185	0.0991	0.1203	425	433	343	509	427	416	26.4	2155
CP1-T101-B20	240	0.0754	0.0926	489	500	400	599	506	494	29.4	2765
CP1-T101-B30	300	0.0601	0.075	548	562	456	684	581	569	32.2	3385
CP1-T101-B40	400	0.047	0.0601	615	633	523	779	669	656	36	4330
CP1-T101-B50	500	0.0366	0.0488	687	711	594	889	769	756	40	5475
CP1-T101-B60	630	0.0283	0.0402	761	791	671	1007	872	862	43.5	6800
CP1-T101-B70	800	0.0221	0.034	829	867	746	1121	978	970	48.4	8770
CP1-T101-B80	1000	0.0176	0.0298	889	939	826	1236	1090	1088	55.9	10935

The above data is approximate and subjected to manufacturing tolerance.

0.6/1 (1.2) KV

Single Core Cables, With Stranded Aluminium Conductors, PVC insulation, Aluminum Tape Armoured, and PVC Sheathed.



Description

- Soft annealed Aluminum conductor, insulated with PVC compound rated 70 °C, Aluminum Tape Armoured and sheathed with PVC compound layer.
- Cables are produced according to IEC 60502 .

Application

- For outdoor and indoor installation in damp and wet locations where mechanical damages are expected to occur.

1 Core - AL/PVC/ATA/PVC

Product Code	Nominal Cross sectional area	Maximum Conductor Resistance		Current Rating						Approx. Overall Diameter	Approx. Weight
		DC at 20 °C	AC at 70 °C	Laid in ground			Laid in free air (Shaded)				
				Flat	Trefoil	Duct	Flat Separated	Flat Touched	Trefoil Touched		
mm ²	Ω/Km	Ω/Km	A	A	A	A	A	A	mm	Kg/Km	
AP1-T101-B11	16	1.91	2.2949	87	88	65	90	73	71	13.3	260
AP1-T101-B12	25	1.2	1.4419	112	113	84	118	96	94	14.8	315
AP1-T101-B13	35	0.868	1.043	134	136	101	144	117	114	15.9	360
AP1-T101-B14	50	0.641	0.7704	158	160	121	174	142	139	17.6	435
AP1-T101-B15	70	0.443	0.5326	194	197	150	218	179	174	19.2	525
AP1-T101-B16	95	0.32	0.385	231	235	180	265	219	213	21.1	645
AP1-T101-B17	120	0.253	0.3046	263	267	207	306	253	247	22.5	745
AP1-T101-B18	150	0.206	0.2483	294	299	233	348	289	281	24.3	880
AP1-T101-B19	185	0.164	0.1981	333	339	268	400	334	325	26.4	1040
AP1-T101-B20	240	0.125	0.1517	385	392	314	472	397	387	29.3	1295
AP1-T101-B30	300	0.1	0.1221	433	443	359	542	459	447	32.1	1555
AP1-T101-B40	400	0.0778	0.0959	493	505	417	626	535	523	36	1970
AP1-T101-B50	500	0.0605	0.0759	559	575	480	724	624	611	39.9	2415
AP1-T101-B60	630	0.0469	0.0606	630	651	549	833	721	708	43.4	2930
AP1-T101-B70	800	0.0367	0.0495	702	729	628	951	829	817	48.8	3680
AP1-T101-B80	1000	0.0291	0.0417	770	806	709	1071	942	933	55.9	4540

The above data is approximate and subjected to manufacturing tolerance.

0.6/1 (1.2) KV Single Core AWA cables

Single Core Cables, With Stranded Copper Conductors, PVC insulation, Aluminum Wire Armoured, and PVC Sheathed.



Description

- Soft annealed copper conductor, insulated with PVC compound rated 70 °C, Aluminum Wire Armoured and sheathed with PVC compound layer.
- Cables are produced according to IEC 60502 or BS 6346.

Application

- For outdoor and indoor installation in damp and wet locations where mechanical damages are expected to occur.

1 Core - Cu/PVC/AWA/PVC

Product Code	Nominal Cross sectional area	Maximum Conductor Resistance		Current Rating						Approx. Overall Diameter	Approx. Weight
		DC at 20 °C	AC at 70 °C	Laid in ground			Laid in free air (Shaded)				
				Flat	Trefoil	Duct	Flat Separated	Flat Touched	Trefoil Touched		
				⊙⊙⊙	⊙⊙⊙	⊙⊙⊙	⊙⊙⊙	⊙⊙⊙	⊙⊙⊙		
mm ²	Ω/Km	Ω/Km	A	A	A	A	A	A	mm	Kg/Km	
CP1-T101-X12	25	0.727	0.87	145	148	112	156	130	126	17.1	555
CP1-T101-X13	35	0.524	0.6272	174	177	134	190	158	154	18.2	670
CP1-T101-X14	50	0.387	0.4634	205	208	159	228	190	185	19.9	825
CP1-T101-X15	70	0.268	0.3212	250	254	196	283	237	231	21.5	1055
CP1-T101-X16	95	0.193	0.2316	296	302	236	340	287	281	23.4	1350
CP1-T101-X17	120	0.153	0.184	334	342	267	389	330	323	24.8	1620
CP1-T101-X18	150	0.124	0.1496	372	382	303	437	374	367	26.6	1930
CP1-T101-X19	185	0.0991	0.1202	415	428	342	493	427	420	28.7	2325
CP1-T101-X20	240	0.0754	0.0924	473	491	397	568	499	493	31.7	2955
CP1-T101-X30	300	0.0601	0.0747	519	544	446	630	563	561	34.8	3630
CP1-T101-X40	400	0.047	0.0598	572	605	502	699	636	639	38.4	4585
CP1-T101-X50	500	0.0366	0.0484	626	669	565	776	716	726	42.4	5740
CP1-T101-X60	630	0.0283	0.0397	677	732	623	850	794	812	46.1	7110
CP1-T101-X70	800	0.0221	0.0333	695	764	662	897	846	877	52	9290
CP1-T101-X80	1000	0.0176	0.0291	727	807	715	973	919	959	59.5	11530

The above data is approximate and subjected to manufacturing tolerance.

0.6/1 (1.2) KV

Single Core Cables, With Stranded Aluminium Conductors, PVC insulation, Aluminum Wire Armoured, and PVC Sheathed.



Description

- Soft annealed Aluminum conductor, insulated with PVC compound rated 70 °C, Aluminum Wire Armoured and sheathed with PVC compound layer.
- Cables are produced according to IEC 60502 or BS 6346.

Application

- For outdoor and indoor installation in damp and wet locations where mechanical damages are expected to occur.

1 Core - AL/PVC/AWA/PVC

Product Code	Nominal Cross sectional area	Maximum Conductor Resistance		Current Rating						Approx. Overall Diameter	Approx. Weight
		DC at 20 °C	AC at 70 °C	Laid in ground			Laid in free air (Shaded)				
				Flat	Trefoil	Duct	Flat Separated	Flat Touched	Trefoil Touched		
mm ²	Ω/Km	Ω/Km	A	A	A	A	A	A	mm	Kg/Km	
AP1-T101-X11	16	1.91	2.2949	88	89	67	93	77	75	15.6	330
AP1-T101-X12	25	1.2	1.4419	113	115	87	122	101	98	17.1	405
AP1-T101-X13	35	0.868	1.043	135	137	104	148	123	119	18.2	465
AP1-T101-X14	50	0.641	0.7703	159	162	124	178	148	144	19.9	545
AP1-T101-X15	70	0.443	0.5326	195	198	152	222	185	180	21.5	650
AP1-T101-X16	95	0.32	0.3849	231	236	184	268	224	219	23.4	780
AP1-T101-X17	120	0.253	0.3046	262	268	209	308	259	253	24.8	895
AP1-T101-X18	150	0.206	0.2483	292	299	237	347	294	287	26.6	1040
AP1-T101-X19	185	0.164	0.198	329	337	270	395	337	331	28.7	1210
AP1-T101-X20	240	0.125	0.1515	377	389	315	459	397	390	31.6	1485
AP1-T101-X30	300	0.1	0.1219	420	435	357	517	454	448	34.7	1800
AP1-T101-X40	400	0.0778	0.0957	470	491	408	585	522	518	38.4	2225
AP1-T101-X50	500	0.0605	0.0757	525	553	467	662	598	598	42.3	2680
AP1-T101-X60	630	0.0469	0.0603	580	617	526	740	678	683	46	3240
AP1-T101-X70	800	0.0367	0.049	616	666	578	807	748	763	52.4	4200
AP1-T101-X80	1000	0.0291	0.0411	658	719	637	889	828	851	59.5	5135

The above data is approximate and subjected to manufacturing tolerance.

0.6/1 (1.2) KV Multi Core Unarmoured Cables

Multicore Cables, with Stranded Copper Conductors PVC Insulated and PVC Sheathed



Description

- Multicore cables of stranded Copper conductors are insulated with PVC compound rated 70°C, assembled together, covered with overall jacket of PVC compound.
- Cables are produced according to IEC 60502, HD 603-3A , HD 603-3G.

Application

- For outdoor and indoor installations in damp and wet locations.

Product Code	Nominal Cross sectional area mm ²	Maximum Conductor Resistance		Current Rating			Approx. Overall Diameter mm	Approx. Overall Diameter Kg/Km
		DC at 20 °C Ω/Km	AC at 70 °C Ω/Km	Laid in ground A	Laid in duct A	Laid in free air (Shaded) A		
2 core cables - Cu/PVC/PVC								
CP1-T102-U04	1.5 RM	12.1	14.6	34	25	21	9.5	127
CP1-T102-U06	2.5 RM	7.41	8.87	43	33	29	10.4	163
CP1-T102-U08	4 RM	4.61	5.54	57	42	41	12.2	233
CP1-T102-U09	6 RM	3.08	3.69	72	53	52	13.4	300
CP1-T102-U10	10 RM	1.83	2.19	93	73	69	14.6	390
CP1-T102-U11	16 RM	1.15	1.39	122	86	92	16.6	550
CP1-T102-U12	25 RM	0.727	0.8701	156	114	121	20.1	730
CP1-T102-U13	35 RM	0.524	0.6273	189	137	149	22.3	940
CP1-T102-U14	50 SM	0.387	0.4634	236	165	186	22.5	1140
CP1-T102-U15	70 SM	0.268	0.3212	287	204	230	24.3	1565
CP1-T102-U16	95 SM	0.193	0.2317	346	249	287	28.6	2145
CP1-T102-U17	120 SM	0.153	0.1841	396	287	336	31.7	2630
CP1-T102-U18	150 SM	0.124	0.1496	443	325	383	34.5	3245
CP1-T102-U19	185 SM	0.0991	0.1201	503	373	446	39.2	4040
CP1-T102-U20	240 SM	0.0754	0.0923	582	439	528	43.8	5245
CP1-T102-U30	300 SM	0.0601	0.0745	653	497	601	47	6475
CP1-T102-U40	400 SM	0.047	0.0595	741	570	699	52.9	8310
3 core cables - Cu/PVC/PVC								
CP1-T103-U04	1.5 RM	12.1	14.6	27	21	20	10	150
CP1-T103-U06	2.5 RM	7.41	8.87	35	27	24	11	195
CP1-T103-U08	4 RM	4.61	5.54	46	36	34	12.8	282
CP1-T103-U09	6 RM	3.08	3.69	59	43	43	14.2	370
CP1-T103-U10	10 RM	1.83	2.19	78	57	59	15.5	490
CP1-T103-U11	16 RM	1.15	1.39	98	71	80	17.6	700
CP1-T103-U12	25 RM	0.727	0.8702	130	94	102	21.4	975
CP1-T103-U13	35 RM	0.524	0.6274	156	114	125	23.8	1270
CP1-T103-U14	50 SM	0.387	0.4635	189	136	151	24.2	1620
CP1-T103-U15	70 SM	0.268	0.3214	232	169	191	27.5	2280
CP1-T103-U16	95 SM	0.193	0.2319	278	205	235	31.6	3120
CP1-T103-U17	120 SM	0.153	0.1844	315	234	270	33.6	3820
CP1-T103-U18	150 SM	0.124	0.15	354	266	310	37.5	4685
CP1-T103-U19	185 SM	0.0991	0.1206	399	303	357	41.7	5870
CP1-T103-U20	240 SM	0.0754	0.0928	462	357	423	47.2	7680
CP1-T103-U30	300 SM	0.0601	0.0752	521	406	486	52.5	9600
CP1-T103-U40	400 SM	0.047	0.0603	593	468	567	59.7	12310
CP1-T103-U50	500 SM	0.0366	0.0489	668	534	650	66.4	15690

The above data is approximate and subjected to manufacturing tolerance.

rm: Round, Stranded
sm: Sector, Stranded

» Cont'd

0.6/1 (1.2) KV Multi Core Unarmoured Cables

Multicore Cables, with Stranded Copper Conductors, PVC Insulated and PVC Sheathed



Product Code	Nominal Cross sectional area mm ²	Maximum Conductor Resistance		Current Rating			Approx. Overall Diameter mm	Approx. Overall Diameter Kg/Km
		DC at 20 °C Ω/Km	AC at 70 °C Ω/Km	Laid in ground	Laid in duct	Laid in free air (Shaded)		
				A	A	A		
4 core cables - Cu/PVC/PVC								
CP1-T104-U04	1.5 RM	12.1	14.6	28	22	21	10.8	180
CP1-T104-U06	2.5 RM	7.41	8.87	36	28	25	11.9	235
CP1-T104-U08	4 RM	4.61	5.54	46	36	36	14	343
CP1-T104-U09	6 RM	3.08	3.69	60	44	45	15.6	454
CP1-T104-U10	10 RM	1.83	2.19	79	58	61	17	610
CP1-T104-U11	16 RM	1.15	1.39	99	73	83	19.6	880
CP1-T104-U12	25 RM	0.727	0.8702	131	96	105	23.5	1270
CP1-T104-U13	35 RM	0.524	0.6274	158	116	129	26.2	1660
CP1-T104-U14	50 SM	0.387	0.4635	195	141	161	28.3	2140
CP1-T104-U15	70 SM	0.268	0.3214	239	175	203	32.1	3025
CP1-T104-U16	95 SM	0.193	0.2319	285	211	247	35.8	4125
CP1-T104-U17	120 SM	0.153	0.1844	324	243	287	39.4	5095
CP1-T104-U18	150 SM	0.124	0.15	364	277	329	43.9	6245
CP1-T104-U19	185 SM	0.0991	0.1206	411	316	379	48.9	7840
CP1-T104-U20	240 SM	0.0754	0.0928	476	372	450	55.2	10195
CP1-T104-U30	300 SM	0.0601	0.0752	537	425	516	61.3	12720
CP1-T104-U40	400 SM	0.047	0.0603	610	490	601	69.9	16365
CP1-T104-U50	500 SM	0.0366	0.0489	689	561	690	77.4	20815
4 core cables with reduced neutral - Cu/PVC/PVC								
CP1-T105-U12	25RM/16RM	0.727 / 1.15	0.8702 / 1.3762	130	95	103	22.6	1170
CP1-T105-U13	35RM/16RM	0.524 / 1.15	0.6274 / 1.3762	157	115	126	24.6	1470
CP1-T105-U14	50SM/25RM	0.387 / 0.727	0.4635 / 0.8702	195	141	161	28.3	1920
CP1-T105-U15	70SM/35RM	0.268 / 0.524	0.3214 / 0.6274	239	175	203	31.9	2680
CP1-T105-U16	95SM/50SM	0.193 / 0.387	0.2319 / 0.4635	282	209	243	34.3	3640
CP1-T105-U17	120SM/70SM	0.153 / 0.268	0.1844 / 0.6214	322	241	282	37.7	4575
CP1-T105-U18	150SM/70SM	0.124 / 0.268	0.15 / 0.6214	361	273	323	41.5	5440
CP1-T105-U19	185SM/95SM	0.0991 / 0.193	0.1206 / 0.2319	407	311	372	46.4	6910
CP1-T105-U20	240SM/120SM	0.0754 / 0.153	0.0928 / 0.1844	472	366	441	52.4	8905
CP1-T105-U30	300SM/150SM	0.0601 / 0.124	0.0752 / 0.15	532	419	507	58.2	11105
CP1-T105-U40	400SM/185SM	0.047 / 0.0991	0.0603 / 0.1206	605	482	590	65.9	14245
CP1-T105-U50	500SM/240SM	0.0366 / 0.0754	0.0489 / 0.0928	682	550	676	73.3	18190

The above data is approximate and subjected to manufacturing tolerance.

rm: Round, Stranded
sm: Sector, Stranded

0.6/1 (1.2) KV Multi Core Unarmoured Cables

Multicore Cables, with Stranded Aluminium Conductors PVC Insulated and PVC Sheathed



Description

- Multicore cables of stranded Aluminium conductors are insulated with PVC compound rated 70°C, assembled together, covered with overall jacket of PVC compound.
- Cables are produced according to IEC 60502, HD 603-3A , HD 603-3G.

Application

- For outdoor and indoor installations in damp and wet locations.

Product Code	Nominal Cross sectional area mm ²	Maximum Conductor Resistance		Current Rating			Approx. Overall Diameter mm	Approx. Overall Diameter Kg/Km
		DC at 20 °C Ω/Km	AC at 70 °C Ω/Km	Laid in ground A	Laid in duct A	Laid in free air (Shaded) A		
2 core cables - AL/PVC/PVC								
AP1-T102-U11	16 RM	1.91	2.295	94	68	71	17.1	310
AP1-T102-U12	25 RM	1.2	1.4419	121	88	94	20.1	430
AP1-T102-U13	35 RM	0.868	1.0431	147	106	116	22.3	535
AP1-T102-U14	50 RM	0.641	0.7704	174	128	141	25.7	670
AP1-T102-U15	70 RM	0.443	0.5327	214	158	178	29.1	865
AP1-T102-U16	95 RM	0.32	0.3851	256	191	218	33.1	1115
AP1-T102-U17	120 RM	0.253	0.3048	292	221	253	36.1	1360
AP1-T102-U18	150 RM	0.206	0.2485	327	249	288	39.9	1675
AP1-T102-U19	185 RM	0.164	0.1982	370	287	333	44.5	2070
AP1-T102-U20	240 RM	0.125	0.1518	429	338	394	50.3	2650
AP1-T102-U30	300 RM	0.1	0.1221	486	386	455	56.1	3285
AP1-T102-U40	400 RM	0.0778	0.096	556	447	529	62.9	4180
3 core cables - AL/PVC/PVC								
AP1-T103-U11	16 RM	1.91	2.295	78	56	59	18.2	380
AP1-T103-U12	25 RM	1.2	1.442	101	73	79	21.4	525
AP1-T103-U13	35 RM	0.868	1.0432	121	89	97	23.8	655
AP1-T103-U14	50 SM	0.641	0.7704	147	106	117	24.2	775
AP1-T103-U15	70 SM	0.443	0.5327	180	131	148	27.5	1035
AP1-T103-U16	95 SM	0.32	0.3851	216	159	182	31.6	1370
AP1-T103-U17	120 SM	0.253	0.3048	245	182	210	33.6	1630
AP1-T103-U18	150 SM	0.206	0.2485	275	206	241	37.5	2015
AP1-T103-U19	185 SM	0.164	0.1983	311	236	278	41.7	2470
AP1-T103-U20	240 SM	0.125	0.1518	362	279	331	47.2	3225
AP1-T103-U30	300 SM	0.1	0.1222	409	318	381	52.5	3945
AP1-T103-U40	400 SM	0.0778	0.0961	470	371	449	59.7	5170
AP1-T103-U50	500 SM	0.0605	0.076	536	428	521	66.4	6470

The above data is approximate and subjected to manufacturing tolerance.

rm: Round, Stranded
sm: Sector, Stranded

» Cont'd

0.6/1 (1.2) KV Multi Core Unarmoured Cables

Multicore Cables, with Stranded Aluminium Conductors PVC Insulated and PVC Sheathed



Product Code	Nominal Cross sectional area mm ²	Maximum Conductor Resistance		Current Rating			Approx. Overall Diameter mm	Approx. Overall Diameter Kg/Km
		DC at 20 °C	AC at 70 °C	Laid in ground	Laid in duct	Laid in free air (Shaded)		
		Ω/Km	Ω/Km	A	A	A		
4 core cables - AL/PVC/PVC								
AP1-T104-U11	16 RM	1.91	2.295	79	57	61	19.9	475
AP1-T104-U12	25 RM	1.2	1.442	102	75	81	23.5	675
AP1-T104-U13	35 RM	0.868	1.0432	123	90	100	26.2	845
AP1-T104-U14	50 SM	0.641	0.7704	151	110	125	28.3	1025
AP1-T104-U15	70 SM	0.443	0.5327	185	136	157	32.1	1360
AP1-T104-U16	95 SM	0.32	0.3851	221	164	192	35.8	1805
AP1-T104-U17	120 SM	0.253	0.3048	252	189	223	39.4	2170
AP1-T104-U18	150 SM	0.206	0.2485	283	216	256	43.9	2685
AP1-T104-U19	185 SM	0.164	0.1983	321	247	296	48.9	3290
AP1-T104-U20	240 SM	0.125	0.1518	372	291	352	55.2	4235
AP1-T104-U30	300 SM	0.1	0.1222	421	333	405	61.3	5215
AP1-T104-U40	400 SM	0.0778	0.0961	484	388	477	69.9	6845
AP1-T104-U50	500 SM	0.0605	0.076	552	450	554	77.4	8485
4 core cables with reduced neutral - AL/PVC/PVC								
AP1-T105-U12	25RM/16RM	1.2 / 1.91	1.442 / 2.295	101	74	80	22.6	630
AP1-T105-U13	35RM/16RM	0.868 / 1.91	1.0432 / 2.295	122	89	98	24.6	760
AP1-T105-U14	50SM/25RM	0.641 / 1.2	0.7704 / 1.442	151	110	125	28.3	935
AP1-T105-U15	70SM/35RM	0.443 / 0.868	0.5327 / 1.0432	186	136	158	31.9	1225
AP1-T105-U16	95SM/50SM	0.32 / 0.641	0.3851 / 0.7704	219	162	188	34.3	1620
AP1-T105-U17	120SM/70SM	0.253 / 0.443	0.3048 / 0.5327	250	187	220	37.7	1960
AP1-T105-U18	150SM/70SM	0.206 / 0.443	0.2485 / 0.5327	280	212	251	41.5	2360
AP1-T105-U19	185SM/95SM	0.164 / 0.32	0.1983 / 0.3851	318	243	290	46.4	2905
AP1-T105-U20	240SM/120SM	0.125 / 0.253	0.1518 / 0.3048	369	287	345	52.4	3720
AP1-T105-U30	300SM/150SM	0.1 / 0.206	0.1222 / 0.2485	417	328	397	58.2	4615
AP1-T105-U40	400SM/185SM	0.0778 / 0.164	0.0961 / 0.1983	479	382	467	65.9	5970
AP1-T105-U50	500SM/240SM	0.0605 / 0.125	0.076 / 0.1518	547	441	543	73.3	7485

The above data is approximate and subjected to manufacturing tolerance.

rm: Round, Stranded
sm: Sector, Stranded

0.6/1 (1.2) KV Multi Core STA cables

Multicore Cables, with Stranded Copper Conductors, PVC Insulated, Steel Tape Armoured and PVC Sheathed



Description

- Multicore cables of stranded Copper conductors are insulated with PVC compound rated 70°C, assembled together, armoured with steel tape and covered with overall jacket of PVC compound.
- Cables are produced according to IEC 60502.

Application

- For outdoor installations in damp and wet locations, where mechanical damages are expected to occur.

Product Code	Nominal Cross sectional area mm ²	Maximum Conductor Resistance		Current Rating			Approx. Overall Diameter mm	Approx. Overall Diameter Kg/Km
		DC at 20 °C Ω/Km	AC at 70 °C Ω/Km	Laid in ground A	Laid in duct A	Laid in free air (Shaded) A		
2 core cables - CU/PVC/STA/PVC								
CP1-T102-A09	6 RM	3.08	3.69	71	53	53	16.4	470
CP1-T102-A10	10 RM	1.83	2.19	93	73	70	17.4	570
CP1-T102-A11	16 RM	1.15	1.39	121	86	93	19.4	750
CP1-T102-G12	25 RM	0.727	0.8701	155	114	123	22.3	930
CP1-T102-G13	35 RM	0.524	0.6273	187	138	151	24.5	1165
CP1-T102-G14	50 SM	0.387	0.4634	232	167	187	24.7	1350
CP1-T102-G15	70 SM	0.268	0.3212	283	203	231	26.5	1785
CP1-T102-G16	95 SM	0.193	0.2317	339	250	287	31.4	2455
CP1-T102-G17	120 SM	0.153	0.1841	391	290	339	35.7	3295
CP1-T102-G18	150 SM	0.124	0.1496	438	328	385	38.3	3910
CP1-T102-G19	185 SM	0.0991	0.1201	496	375	447	43.2	4845
CP1-T102-G20	240 SM	0.0754	0.0923	573	440	527	47.8	6130
CP1-T102-G30	300 SM	0.0601	0.0745	640	496	597	51.2	7450
CP1-T102-G40	400 SM	0.047	0.0595	726	570	691	57.1	9400
3 core cables - CU/PVC/STA/PVC								
CP1-T103-G08	4 RM	4.61	5.54	45	36	35	15.8	440
CP1-T103-G09	6 RM	3.08	3.69	58	43	44	17	545
CP1-T103-G10	10 RM	1.83	2.19	77	57	59	18.4	680
CP1-T103-G11	16 RM	1.15	1.39	96	72	81	20.5	910
CP1-T103-G12	25 RM	0.727	0.8702	128	95	103	23.6	1210
CP1-T103-G13	35 RM	0.524	0.6274	154	114	126	26	1535
CP1-T103-G14	50 SM	0.387	0.4635	186	136	152	26.6	1860
CP1-T103-G15	70 SM	0.268	0.3214	228	170	191	30.1	2560
CP1-T103-G16	95 SM	0.193	0.2319	275	207	237	35.6	3780
CP1-T103-G17	120 SM	0.153	0.1844	312	236	272	37.4	4500
CP1-T103-G18	150 SM	0.124	0.15	349	267	311	41.7	5490
CP1-T103-G19	185 SM	0.0991	0.1206	394	304	357	45.9	6750
CP1-T103-G20	240 SM	0.0754	0.0928	456	357	422	51.4	8660
CP1-T103-G30	300 SM	0.0601	0.0752	513	405	483	56.5	10665
CP1-T103-G40	400 SM	0.047	0.0603	583	468	561	63.9	13545
CP1-T103-G50	500 SM	0.0366	0.0489	655	532	641	70.6	17060

The above data is approximate and subjected to manufacturing tolerance.

rm: Round, Stranded
sm: Sector, Stranded

» Cont'd

0.6/1 (1.2) KV Multi Core STA cables

Multicore Cables, with Stranded Copper Conductors, PVC Insulated, Steel Tape Armoured and PVC Sheathed



Product Code	Nominal Cross sectional area mm ²	Maximum Conductor Resistance		Current Rating			Approx. Overall Diameter mm	Approx. Overall Diameter Kg/Km
		DC at 20 °C	AC at 70 °C	Laid in ground	Laid in duct	Laid in free air (Shaded)		
		Ω/Km	Ω/Km	A	A	A		
4 core cables - Cu/PVC/STA/PVC								
CP1-T104-G08	4 RM	4.61	5.54	47	37	37	17	520
CP1-T104-G09	6 RM	3.08	3.69	60	45	46	18.4	650
CP1-T104-G10	10 RM	1.83	2.19	80	59	63	19.8	820
CP1-T104-G11	16 RM	1.15	1.39	100	74	85	22.2	1120
CP1-T104-G12	25 RM	0.727	0.8702	130	96	105	25.7	1505
CP1-T104-G13	35 RM	0.524	0.6274	156	117	130	28.4	1925
CP1-T104-G14	50 SM	0.387	0.4635	191	142	161	31.1	2455
CP1-T104-G15	70 SM	0.268	0.3214	236	177	205	35.9	3680
CP1-T104-G16	95 SM	0.193	0.2319	282	213	249	39.6	4855
CP1-T104-G17	120 SM	0.153	0.1844	320	246	288	43.4	5920
CP1-T104-G18	150 SM	0.124	0.15	359	279	329	48.1	7185
CP1-T104-G19	185 SM	0.0991	0.1206	406	318	378	53.1	8875
CP1-T104-G20	240 SM	0.0754	0.0928	470	372	447	59.4	11345
CP1-T104-G30	300 SM	0.0601	0.0752	529	424	512	65.5	14000
CP1-T104-G40	400 SM	0.047	0.0603	601	490	594	74.3	17860
CP1-T104-G50	500 SM	0.0366	0.0489	678	558	684	83	23230
4 core cables with reduced neutral - Cu/PVC/STA/PVC								
CP1-T105-G12	25RM / 16RM	0.727 / 1.15	0.8702 / 1.3762	129	96	104	24.8	1395
CP1-T105-G13	35RM / 16RM	0.524 / 1.15	0.6274 / 1.3762	155	116	127	26.8	1715
CP1-T105-G14	50SM / 25RM	0.387 / 0.727	0.4635 / 0.8702	193	143	162	30.5	2225
CP1-T105-G15	70SM / 35RM	0.268 / 0.524	0.3214 / 0.6274	236	176	203	34.5	3050
CP1-T105-G16	95SM / 50SM	0.193 / 0.387	0.2319 / 0.4635	279	211	245	38.1	4340
CP1-T105-G17	120SM / 70SM	0.153 / 0.268	0.1844 / 0.3214	318	243	284	41.7	5365
CP1-T105-G18	150SM / 70SM	0.124 / 0.268	0.15 / 0.3214	356	274	323	45.7	6330
CP1-T105-G19	185SM / 95SM	0.0991 / 0.193	0.1206 / 0.2319	403	315	372	50.4	7860
CP1-T105-G20	240SM / 120SM	0.0754 / 0.153	0.0928 / 0.1844	466	367	439	56.4	9975
CP1-T105-G30	300SM / 150SM	0.0601 / 0.124	0.0752 / 0.15	524	418	503	62.2	12285
CP1-T105-G40	400SM / 185SM	0.047 / 0.0991	0.0603 / 0.1206	595	482	582	70.3	15650
CP1-T105-G50	500SM / 240SM	0.0366 / 0.0754	0.0489 / 0.0928	671	550	670	78.9	20475

The above data is approximate and subjected to manufacturing tolerance.

rm: Round, Stranded
sm: Sector, Stranded

0.6/1 (1.2) KV Multi Core STA cables

Multicore Cables, with Stranded Aluminium Conductors, PVC Insulated, Steel Tape Armoured and PVC Sheathed



Description

- Multicore cables of stranded Aluminium conductors are insulated with PVC compound rated 70°C, assembled together, armoured with steel tape and covered with overall jacket of PVC compound.
- Cables are produced according to IEC 60502.

Application

- For outdoor installations in damp wet locations, where mechanical damages are expected to occur.

Product Code	Nominal Cross sectional area mm ²	Maximum Conductor Resistance		Current Rating			Approx. Overall Diameter mm	Approx. Overall Diameter Kg/Km
		DC at 20 °C Ω/Km	AC at 70 °C Ω/Km	Laid in ground A	Laid in duct A	Laid in free air (Shaded) A		
2 core cables - AL/PVC/STA/PVC								
AP1-T102-G11	16 RM	1.91	2.295	93	68	72	19.3	485
AP1-T102-G12	25 RM	1.2	1.4419	120	89	95	22.3	635
AP1-T102-G13	35 RM	0.868	1.0431	145	107	117	24.5	755
AP1-T102-G14	50 RM	0.641	0.7704	172	129	142	27.9	930
AP1-T102-G15	70 RM	0.443	0.5327	212	160	179	31.3	1155
AP1-T102-G16	95 RM	0.32	0.3851	252	192	217	35.9	1500
AP1-T102-G17	120 RM	0.253	0.3048	289	224	255	40.1	2140
AP1-T102-G18	150 RM	0.206	0.2485	324	253	290	43.7	2515
AP1-T102-G19	185 RM	0.164	0.1982	366	289	333	48.5	3030
AP1-T102-G20	240 RM	0.125	0.1518	425	339	394	54.3	3730
AP1-T102-G30	300 RM	0.1	0.1221	481	388	453	60.3	4515
AP1-T102-G40	400 RM	0.0778	0.096	549	449	526	67.1	5550
3 core cables - AL/PVC/STA/PVC								
AP1-T103-G11	16 RM	1.91	2.295	77	57	60	20.4	575
AP1-T103-G12	25 RM	1.2	1.442	99	74	80	23.6	765
AP1-T103-G13	35 RM	0.868	1.0432	120	89	98	26	925
AP1-T103-G14	50 SM	0.641	0.7704	145	105	118	26.6	1020
AP1-T103-G15	70 SM	0.443	0.5327	177	132	148	30.1	1315
AP1-T103-G16	95 SM	0.32	0.3851	213	161	184	35.6	2030
AP1-T103-G17	120 SM	0.253	0.3048	243	184	212	37.4	2310
AP1-T103-G18	150 SM	0.206	0.2485	272	208	242	41.7	2820
AP1-T103-G19	185 SM	0.164	0.1983	307	238	278	45.9	3350
AP1-T103-G20	240 SM	0.125	0.1518	357	280	330	51.4	4210
AP1-T103-G30	300 SM	0.1	0.1222	404	319	380	56.5	5010
AP1-T103-G40	400 SM	0.0778	0.0961	463	372	446	63.9	6405
AP1-T103-G50	500 SM	0.0605	0.076	527	428	516	70.6	7835

The above data is approximate and subjected to manufacturing tolerance.

rm: Round, Stranded
sm: Sector, Stranded

» Cont'd

0.6/1 (1.2) KV Multi Core STA cables

Multicore Cables, with Stranded Aluminium Conductors, PVC Insulated, Steel Tape Armoured and PVC Sheathed



Product Code	Nominal Cross sectional area mm ²	Maximum Conductor Resistance		Current Rating			Approx. Overall Diameter mm	Approx. Overall Diameter Kg/Km
		DC at 20 °C	AC at 70 °C	Laid in ground	Laid in duct	Laid in free air (Shaded)		
		Ω/Km	Ω/Km	A	A	A		
4 core cables - AL/PVC/STA/PVC								
AP1-T104-G11	16 RM	1.91	2.295	78	57	62	22.1	670
AP1-T104-G12	25 RM	1.2	1.442	101	75	82	25.7	910
AP1-T104-G13	35 RM	0.868	1.0432	121	91	100	28.4	1105
AP1-T104-G14	50 SM	0.641	0.7704	149	110	125	31.1	1340
AP1-T104-G15	70 SM	0.443	0.5327	184	138	159	35.9	2015
AP1-T104-G16	95 SM	0.32	0.3851	219	166	193	39.6	2535
AP1-T104-G17	120 SM	0.253	0.3048	249	192	224	43.4	2995
AP1-T104-G18	150 SM	0.206	0.2485	279	217	256	48.1	3620
AP1-T104-G19	185 SM	0.164	0.1983	317	248	295	53.1	4325
AP1-T104-G20	240 SM	0.125	0.1518	368	292	350	59.4	5390
AP1-T104-G30	300 SM	0.1	0.1222	416	334	403	65.5	6495
AP1-T104-G40	400 SM	0.0778	0.0961	477	389	472	74.3	8340
AP1-T104-G50	500 SM	0.0605	0.076	546	449	550	83	10900
4 core cables with reduced neutral - AL/PVC/STA/PVC								
AP1-T105-G12	25RM/16RM	1.2 / 1.91	1.442 / 2.295	100	74	81	24.8	855
AP1-T105-G13	35RM/16RM	0.868 / 1.91	1.0432 / 2.295	120	90	99	26.8	1005
AP1-T105-G14	50SM/25RM	0.641 / 1.2	0.7704 / 1.442	149	111	125	30.5	1240
AP1-T105-G15	70SM/35RM	0.443 / 0.868	0.5327 / 1.0432	183	137	158	34.5	1600
AP1-T105-G16	95SM/50SM	0.32 / 0.641	0.3851 / 0.7704	217	164	190	38.1	2315
AP1-T105-G17	120SM/70SM	0.253 / 0.443	0.3048 / 0.5327	248	189	221	41.7	2750
AP1-T105-G18	150SM/70SM	0.206 / 0.443	0.2485 / 0.5327	277	213	251	45.7	3245
AP1-T105-G19	185SM/95SM	0.164 / 0.32	0.1983 / 0.3851	314	246	290	50.4	3860
AP1-T105-G20	240SM/120SM	0.125 / 0.253	0.1518 / 0.3048	365	288	344	56.4	4790
AP1-T105-G30	300SM/150SM	0.1 / 0.206	0.1222 / 0.2485	412	329	396	62.2	5795
AP1-T105-G40	400SM/185SM	0.0778 / 0.164	0.0961 / 0.1983	473	383	463	70.3	7375
AP1-T105-G50	500SM/240SM	0.0605 / 0.125	0.076 / 0.1518	540	443	539	78.9	9775

The above data is approximate and subjected to manufacturing tolerance.

rm: Round, Stranded
sm: Sector, Stranded

0.6/1 (1.2) KV Multi Core SWA Cables

Multicore Cables, with Stranded Copper Conductors, PVC Insulated, Steel Wire Armoured and PVC Sheathed



Description

- Multicore cables of stranded Copper conductors are insulated with PVC compound rated 70°C, assembled together, armoured with steel wires and covered with overall jacket of PVC compound.
- Cables are produced according to IEC 60502 or BS 6346.

Application

- For outdoor installations in damp wet locations where mechanical damages are expected to occur.

Product Code	Nominal Cross sectional area mm ²	Maximum Conductor Resistance		Current Rating			Approx. Overall Diameter mm	Approx. Overall Diameter Kg/Km
		DC at 20 °C Ω/Km	AC at 70 °C Ω/Km	Laid in ground A	Laid in duct A	Laid in free air (Shaded) A		
2 core cables - CU/PVC/SWA/PVC								
CP1-T102-W08	4 RM	4.61	5.54	57	44	42	15.8	480
CP1-T102-W09	6 RM	3.08	3.69	72	54	54	17.7	660
CP1-T102-W10	10 RM	1.83	2.19	93	75	72	18.9	784
CP1-T102-W11	16 RM	1.15	1.39	122	88	96	20.9	985
CP1-T102-W12	25 RM	0.727	0.8701	156	117	127	25.6	1430
CP1-T102-W13	35 RM	0.524	0.6273	188	141	155	27.8	1720
CP1-T102-W14	50 SM	0.387	0.4634	234	171	193	28.2	1920
CP1-T102-W15	70 SM	0.268	0.3212	287	211	241	30.4	2560
CP1-T102-W16	95 SM	0.193	0.2317	343	255	296	35.3	3360
CP1-T102-W17	120 SM	0.153	0.1841	392	293	345	38.2	3950
CP1-T102-W18	150 SM	0.124	0.1496	439	332	394	42	5030
CP1-T102-W19	185 SM	0.0991	0.1201	494	380	453	47.1	6115
CP1-T102-W20	240 SM	0.0754	0.0923	569	440	531	51.5	7515
CP1-T102-W30	300 SM	0.0601	0.0745	633	494	598	54.9	8910
CP1-T102-W40	400 SM	0.047	0.0595	711	562	686	60.8	11020
3 core cables - CU/PVC/SWA/PVC								
CP1-T103-W08	4 RM	4.61	5.54	45	36	36	17.2	630
CP1-T103-W09	6 RM	3.08	3.69	58	43	45	18.6	750
CP1-T103-W10	10 RM	1.83	2.19	78	57	61	19.8	905
CP1-T103-W11	16 RM	1.15	1.39	97	71	83	22	1170
CP1-T103-W12	25 RM	0.727	0.8702	129	97	106	26.9	1755
CP1-T103-W13	35 RM	0.524	0.6274	156	117	130	29.3	2135
CP1-T103-W14	50 SM	0.387	0.4635	188	140	157	30.1	2470
CP1-T103-W15	70 SM	0.268	0.3214	231	174	198	34	3420
CP1-T103-W16	95 SM	0.193	0.2319	276	210	242	38.1	4435
CP1-T103-W17	120 SM	0.153	0.1844	314	238	277	39.9	5205
CP1-T103-W18	150 SM	0.124	0.15	350	271	317	45.4	6680
CP1-T103-W19	185 SM	0.0991	0.1206	394	307	362	49.6	8085
CP1-T103-W20	240 SM	0.0754	0.0928	454	358	425	55.1	10115
CP1-T103-W30	300 SM	0.0601	0.0752	507	405	484	60.4	12315
CP1-T103-W40	400 SM	0.047	0.0603	569	459	556	68.9	16155
CP1-T103-W50	500 SM	0.0366	0.0489	631	514	627	75.8	19925

The above data is approximate and subjected to manufacturing tolerance.

rm: Round, Stranded
sm: Sector, Stranded

» Cont'd

0.6/1 (1.2) KV Multi Core SWA Cables

Multicore Cables, with Stranded Copper Conductors, PVC Insulated, Steel Wire Armoured and PVC Sheathed



Product Code	Nominal Cross sectional area mm ²	Maximum Conductor Resistance		Current Rating			Approx. Overall Diameter mm	Approx. Overall Diameter Kg/Km
		DC at 20 °C	AC at 70 °C	Laid in ground	Laid in duct	Laid in free air (Shaded)		
		Ω/Km	Ω/Km	A	A	A		
4 core cables - CU/PVC/SWA/PVC								
CP1-T104-W08	4 RM	4.61	5.54	49	36	36	18.4	725
CP1-T104-W09	6 RM	3.08	3.69	62	43	45	19.9	870
CP1-T104-W10	10 RM	1.83	2.19	84	57	60	21.3	1060
CP1-T104-W11	16 RM	1.15	1.39	105	73	82	24.4	1520
CP1-T104-W12	25 RM	0.727	0.8702	131	99	109	29	2085
CP1-T104-W13	35 RM	0.524	0.6274	157	119	133	31.9	2590
CP1-T104-W14	50 SM	0.387	0.4635	194	146	167	35	3360
CP1-T104-W15	70 SM	0.268	0.3214	238	180	209	38.6	4375
CP1-T104-W16	95 SM	0.193	0.2319	283	217	254	43.3	5990
CP1-T104-W17	120 SM	0.153	0.1844	321	249	293	47.1	7165
CP1-T104-W18	150 SM	0.124	0.15	359	281	334	51.8	8565
CP1-T104-W19	185 SM	0.0991	0.1206	404	320	382	56.8	10380
CP1-T104-W20	240 SM	0.0754	0.0928	465	371	448	63.1	13050
CP1-T104-W30	300 SM	0.0601	0.0752	520	419	509	69	15860
CP1-T104-W40	400 SM	0.047	0.0603	580	474	582	79.3	20890
CP1-T104-W50	500 SM	0.0366	0.0489	643	532	657	86.8	25770
4 core cables with reduced neutral - CU/PVC/SWA/PVC								
CP1-T105-W12	25RM / 16RM	0.727 / 1.15	0.8702 / 1.3762	130	98	107	28.1	1965
CP1-T105-W13	35RM / 16RM	0.524 / 1.15	0.6274 / 1.3762	156	118	131	30.3	2340
CP1-T105-W14	50SM / 25RM	0.387 / 0.727	0.4635 / 0.8702	195	146	167	34.4	3105
CP1-T105-W15	70SM / 35RM	0.268 / 0.524	0.3214 / 0.6274	238	180	209	38.4	4065
CP1-T105-W16	95SM / 50SM	0.193 / 0.387	0.2319 / 0.4635	281	214	249	40.6	5030
CP1-T105-W17	120SM / 70SM	0.153 / 0.268	0.1844 / 0.3214	319	246	289	45.6	6575
CP1-T105-W18	150SM / 70SM	0.124 / 0.268	0.15 / 0.3214	356	277	328	49.4	7660
CP1-T105-W19	185SM / 95SM	0.0991 / 0.193	0.1206 / 0.2319	402	316	376	54.1	9325
CP1-T105-W20	240SM / 120SM	0.0754 / 0.153	0.0928 / 0.1844	462	368	441	60.1	11590
CP1-T105-W30	300SM / 150SM	0.0601 / 0.124	0.0752 / 0.15	517	414	501	65.9	14060
CP1-T105-W40	400SM / 185SM	0.047 / 0.0991	0.0603 / 0.1206	577	469	574	75.3	18480
CP1-T105-W50	500SM / 240SM	0.0366 / 0.0754	0.0489 / 0.0928	639	525	647	82.7	22855

The above data is approximate and subjected to manufacturing tolerance.

rm: Round, Stranded
sm: Sector, Stranded

0.6/1 (1.2) KV Multi Core SWA Cables

Multicore Cables, with Stranded Aluminium Conductors, PVC Insulated, Steel Wire Armoured and PVC Sheathed



Description

- Multicore cables of stranded Aluminium conductors are insulated with PVC compound rated 70°C, assembled together, armoured with steel wires and covered with overall jacket of PVC compound.
- Cables are produced according to IEC 60502.

Application

- For outdoor installations in damp wet locations where mechanical damages are expected to occur.

Product Code	Nominal Cross sectional area mm ²	Maximum Conductor Resistance		Current Rating			Approx. Overall Diameter mm	Approx. Overall Diameter Kg/Km
		DC at 20 °C	AC at 70 °C	Laid in ground	Laid in duct	Laid in free air (Shaded)		
		Ω/Km	Ω/Km	A	A	A		
2 core cables - AL/PVC/SWA/PVC								
AP1-T102-W11	16 RM	1.91	2.295	94	70	74	21.5	770
AP1-T102-W12	25 RM	1.2	1.4419	121	91	99	25.6	1130
AP1-T102-W13	35 RM	0.868	1.0431	146	110	120	27.8	1310
AP1-T102-W14	50 RM	0.641	0.7704	173	131	146	31.4	1575
AP1-T102-W15	70 RM	0.443	0.5327	214	163	184	35.2	2055
AP1-T102-W16	95 RM	0.32	0.3851	254	196	223	39.8	2535
AP1-T102-W17	120 RM	0.253	0.3048	290	225	258	42.6	2880
AP1-T102-W18	150 RM	0.206	0.2485	325	256	295	47.4	3790
AP1-T102-W19	185 RM	0.164	0.1982	366	291	337	52.4	4460
AP1-T102-W20	240 RM	0.125	0.1518	423	340	396	58	5295
AP1-T102-W30	300 RM	0.1	0.1221	477	387	453	64	6270
AP1-T102-W40	400 RM	0.0778	0.096	541	444	523	70.8	7495
3 core cables - AL/PVC/SWA/PVC								
AP1-T103-W11	16 RM	1.91	2.295	78	57	62	22.6	875
AP1-T103-W12	25 RM	1.2	1.442	100	76	82	26.9	1305
AP1-T103-W13	35 RM	0.868	1.0432	121	91	101	29.3	1520
AP1-T103-W14	50 SM	0.641	0.7704	146	109	122	30.1	1625
AP1-T103-W15	70 SM	0.443	0.5327	180	135	154	34	2175
AP1-T103-W16	95 SM	0.32	0.3851	215	163	188	38.1	2685
AP1-T103-W17	120 SM	0.253	0.3048	244	185	216	39.9	3015
AP1-T103-W18	150 SM	0.206	0.2485	273	211	247	45.4	4010
AP1-T103-W19	185 SM	0.164	0.1983	308	240	283	49.6	4685
AP1-T103-W20	240 SM	0.125	0.1518	357	282	334	55.1	5665
AP1-T103-W30	300 SM	0.1	0.1222	402	321	383	60.4	6660
AP1-T103-W40	400 SM	0.0778	0.0961	458	370	447	68.9	9015
AP1-T103-W50	500 SM	0.0605	0.076	516	421	512	75.8	10705

The above data is approximate and subjected to manufacturing tolerance.

rm: Round, Stranded
sm: Sector, Stranded

» Cont'd

0.6/1 (1.2) KV Multi Core SWA Cables

Multicore Cables, with Stranded Aluminium Conductors, PVC Insulated, Steel Wire Armoured and PVC Sheathed



Product Code	Nominal Cross sectional area mm ²	Maximum Conductor Resistance		Current Rating			Approx. Overall Diameter mm	Approx. Overall Diameter Kg/Km
		DC at 20 °C	AC at 70 °C	Laid in ground	Laid in duct	Laid in free air (Shaded)		
		Ω/Km	Ω/Km	A	A	A		
4 core cables - AL/PVC/SWA/PVC								
AP1-T104-W11	16 RM	1.91	2.295	79	59	64	25.4	1175
AP1-T104-W12	25 RM	1.2	1.442	102	77	84	29	1490
AP1-T104-W13	35 RM	0.868	1.0432	122	93	103	31.9	1770
AP1-T104-W14	50 SM	0.641	0.7704	150	113	130	35	2245
AP1-T104-W15	70 SM	0.443	0.5327	185	140	162	38.6	2710
AP1-T104-W16	95 SM	0.32	0.3851	220	168	198	43.3	3670
AP1-T104-W17	120 SM	0.253	0.3048	251	194	229	47.1	4240
AP1-T104-W18	150 SM	0.206	0.2485	280	219	260	51.8	5000
AP1-T104-W19	185 SM	0.164	0.1983	317	251	299	56.8	5830
AP1-T104-W20	240 SM	0.125	0.1518	367	292	353	63.1	7090
AP1-T104-W30	300 SM	0.1	0.1222	413	333	404	69	8355
AP1-T104-W40	400 SM	0.0778	0.0961	468	383	469	79.3	11370
AP1-T104-W50	500 SM	0.0605	0.076	528	437	538	86.8	13440
4 core cables with reduced neutral - AL/PVC/SWA/PVC								
AP1-T105-W12	25RM/16RM	1.2 / 1.91	1.442 / 2.295	101	76	84	28.1	1425
AP1-T105-W13	35RM/16RM	0.868 / 1.91	1.0432 / 2.295	121	92	101	30.3	1630
AP1-T105-W14	50SM/25RM	0.641 / 1.2	0.7704 / 1.442	151	113	130	34.4	2120
AP1-T105-W15	70SM/35RM	0.443 / 0.868	0.5327 / 1.0432	185	140	163	38.4	2610
AP1-T105-W16	95SM/50SM	0.32 / 0.641	0.3851 / 0.7704	218	167	194	40.6	3005
AP1-T105-W17	120SM/70SM	0.253 / 0.443	0.3048 / 0.5327	249	192	225	45.6	3955
AP1-T105-W18	150SM/70SM	0.206 / 0.443	0.2485 / 0.5327	278	216	256	49.4	4580
AP1-T105-W19	185SM/95SM	0.164 / 0.32	0.1983 / 0.3851	315	248	294	54.1	5325
AP1-T105-W20	240SM/120SM	0.125 / 0.253	0.1518 / 0.3048	364	290	347	60.1	6405
AP1-T105-W30	300SM/150SM	0.1 / 0.206	0.1222 / 0.2485	410	328	397	65.9	7575
AP1-T105-W40	400SM/185SM	0.0778 / 0.164	0.0961 / 0.1983	465	379	461	75.3	10205
AP1-T105-W50	500SM/240SM	0.0605 / 0.125	0.076 / 0.1518	524	431	529	82.7	12155

The above data is approximate and subjected to manufacturing tolerance.

rm: Round, Stranded
sm: Sector, Stranded

0.6/1 (1.2) KV Single Core Unarmoured Cables

Single Core Cables, with Stranded Circular Copper Conductors, XLPE Insulated and PVC Sheathed



Description

- Soft annealed stranded Copper conductor, Insulated with XLPE compound covered with a layer of PVC compound to form the overall jacket.
- Cables are according to IEC 60502 or BS 7889.

Application

- For outdoor and indoor installations in damp and wet locations. They are normally used for power distribution in urban networks, in industrial plants, as well as in Thermopower and Hydropower stations.

1 Core - Cu/XLPE/PVC

Product Code	Nominal Cross sectional area	Maximum Conductor Resistance		Current Rating						Approx. Overall Diameter	Approx. Weight
		DC at 20 °C	AC at 90 °C	Laid in ground			Laid in free air (Shaded)				
				Flat	Trefoil	Duct	Flat Separated	Flat Touched	Trefoil Touched		
mm ²	Ω/Km	Ω/Km	A	A	A	A	A	A	mm	Kg/Km	
CX1-T101-U08	4	4.61	5.54	60	60	42	65	47	44	6.5	75
CX1-T101-U09	6	3.08	3.69	76	77	56	80	59	59	7	98
CX1-T101-U10	10	1.83	2.19	103	105	72	103	79	75	7.7	135
CX1-T101-U11	16	1.15	1.39	129	131	92	142	110	105	8.7	195
CX1-T101-U12	25	0.727	0.9272	166	168	118	179	138	134	10	285
CX1-T101-U13	35	0.524	0.6685	199	201	143	220	171	166	11.1	380
CX1-T101-U14	50	0.387	0.4939	236	239	172	269	210	204	12.6	500
CX1-T101-U15	70	0.268	0.3425	288	292	214	340	268	260	14.4	700
CX1-T101-U16	95	0.193	0.2472	344	349	259	418	331	321	16.1	950
CX1-T101-U17	120	0.153	0.1965	391	397	298	486	386	375	17.7	1190
CX1-T101-U18	150	0.124	0.1598	439	445	339	557	446	433	19.7	1465
CX1-T101-U19	185	0.0991	0.1285	496	503	390	646	519	503	21.8	1815
CX1-T101-U20	240	0.0754	0.099	574	583	457	771	622	602	24.6	2365
CX1-T101-U30	300	0.0601	0.0803	647	658	524	895	722	699	27.4	2945
CX1-T101-U40	400	0.047	0.0645	732	744	603	1044	842	815	30.6	3780
CX1-T101-U50	500	0.0366	0.0525	826	840	695	1222	981	950	34.6	4845
CX1-T101-U60	630	0.0283	0.0431	925	942	794	1420	1132	1096	38.9	6165
CX1-T101-U70	800	0.0221	0.0366	1022	1042	894	1639	1291	1249	43.8	8045
CX1-T101-U80	1000	0.0176	0.0321	1119	1142	999	1894	1473	1423	51.1	10050

The above data is approximate and subjected to manufacturing tolerance.

0.6/1 (1.2) KV

Single Core Cables, with Stranded Aluminium Copper Conductors, XPLE Insulated and PVC Sheathed



Description

- Soft annealed stranded Aluminum conductor, Insulated with XLPE compound covered with a layer of PVC compound to form the overall jacket.
- Cables are according to IEC 60502.

Application

- For outdoor and indoor installations in damp and wet locations. They are normally used for power distribution in urban networks, in industrial plants, as well as in Thermopower and Hydropower stations.

1 Core - AL/XLPE/PVC

Product Code	Nominal Cross sectional area	Maximum Conductor Resistance		Current Rating						Approx. Overall Diameter	Approx. Weight
		DC at 20 °C	AC at 90 °C	Laid in ground			Laid in free air (Shaded)				
				Flat	Trefoil	Duct	Flat Separated	Flat Touched	Trefoil Touched		
mm ²	Ω/Km	Ω/Km	A	A	A	A	A	A	mm	Kg/Km	
AX1-T101-U11	16	1.91	2.4489	100	101	70	104	80	77	8.5	100
AX1-T101-U12	25	1.2	1.5387	129	130	92	139	107	104	10	140
AX1-T101-U13	35	0.868	1.1131	154	156	111	171	133	129	11.1	175
AX1-T101-U14	50	0.641	0.8221	183	185	134	208	163	158	12.6	220
AX1-T101-U15	70	0.443	0.5684	224	227	166	264	208	202	14.4	295
AX1-T101-U16	95	0.32	0.4109	267	271	201	324	256	249	16.1	380
AX1-T101-U17	120	0.253	0.3252	304	309	232	377	300	291	17.7	465
AX1-T101-U18	150	0.206	0.2651	341	346	263	432	346	336	19.7	575
AX1-T101-U19	185	0.164	0.2116	386	392	304	502	404	392	21.8	700
AX1-T101-U20	240	0.125	0.162	448	456	357	599	485	470	24.5	900
AX1-T101-U30	300	0.1	0.1305	507	516	411	696	566	548	27.3	1115
AX1-T101-U40	400	0.0778	0.1026	580	590	478	819	667	646	30.6	1420
AX1-T101-U50	500	0.0605	0.0813	663	675	558	965	787	762	34.5	1785
AX1-T101-U60	630	0.0469	0.0649	754	768	647	1131	922	892	38.8	2300
AX1-T101-U70	800	0.0367	0.053	850	867	744	1329	1077	1042	44.2	2950
AX1-T101-U80	1000	0.0291	0.0446	949	968	847	1556	1249	1207	51.1	3655

The above data is approximate and subjected to manufacturing tolerance.

0.6/1 (1.2) KV Single Core ATA cables

Single Core Cables, With Stranded Copper Conductors, XLPE insulation, Aluminium Tape Armoured, and PVC Sheathed.



Description

- Soft annealed copper conductor, insulated with XLPE compound rated 90 °C, Aluminum Tape Armoured and sheathed with PVC compound layer.
- Cables are produced according to IEC 60502.

Application

- For outdoor and indoor installation in damp and wet locations where mechanical damages are expected to occur.

1 Core - Cu/XLPE/ATA/PVC

Product Code	Nominal Cross sectional area	Maximum Conductor Resistance		Current Rating						Approx. Overall Diameter	Approx. Weight
		DC at 20 °C	AC at 90 °C	Laid in ground			Laid in free air (Shaded)				
				Flat	Trefoil	Duct	Flat Separated	Flat Touched	Trefoil Touched		
mm ²	Ω/Km	Ω/Km	A	A	A	A	A	A	mm	Kg/Km	
CX1-T101-B12	25	0.727	0.9272	168	170	126	190	154	150	14.2	430
CX1-T101-B13	35	0.524	0.6684	201	204	151	233	188	183	15.3	525
CX1-T101-B14	50	0.387	0.4938	237	241	181	281	229	222	16.8	660
CX1-T101-B15	70	0.268	0.3423	290	294	223	352	287	279	18.6	880
CX1-T101-B16	95	0.193	0.2469	346	351	269	429	351	341	20.1	1140
CX1-T101-B17	120	0.153	0.1962	392	399	309	495	406	395	21.7	1395
CX1-T101-B18	150	0.124	0.1595	439	447	352	563	465	452	23.5	1680
CX1-T101-B19	185	0.0991	0.1281	494	504	400	646	536	522	25.6	2055
CX1-T101-B20	240	0.0754	0.0985	570	583	470	762	636	620	28.2	2615
CX1-T101-B30	300	0.0601	0.0797	640	656	533	872	732	715	31	3220
CX1-T101-B40	400	0.047	0.0638	719	739	613	997	846	828	34.6	4120
CX1-T101-B50	500	0.0366	0.0516	805	831	698	1141	975	957	38.6	5230
CX1-T101-B60	630	0.0283	0.0423	892	926	792	1291	1110	1094	42.7	6575
CX1-T101-B70	800	0.0221	0.0356	975	1018	884	1439	1248	1236	48	8545
CX1-T101-B80	1000	0.0176	0.031	1049	1105	981	1592	1396	1390	55.5	10660

The above data is approximate and subjected to manufacturing tolerance.

0.6/1 (1.2) KV

Single Core Cables, With Stranded Aluminium Conductors, XLPE insulation, Aluminium Tape Armoured, and PVC Sheathed.



Description

- Soft annealed Aluminum conductor, insulated with XLPE compound rated 90 °C, Aluminum Tape Armoured and sheathed with PVC compound layer.
- Cables are produced according to IEC 60502.

Application

- For outdoor and indoor installation in damp and wet locations where mechanical damages are expected to occur.

1 Core - AL/XLPE/ATA/PVC

Product Code	Nominal Cross sectional area	Maximum Conductor Resistance		Current Rating						Approx. Overall Diameter	Approx. Weight
		DC at 20 °C	AC at 90 °C	Laid in ground			Laid in free air (Shaded)				
				Flat	Trefoil	Duct	Flat Separated	Flat Touched	Trefoil Touched		
mm ²	Ω/Km	Ω/Km	A	A	A	A	A	A	mm	Kg/Km	
AX1-T101-B11	16	1.91	2.4489	102	103	76	112	90	88	12.7	230
AX1-T101-B12	25	1.2	1.5386	130	132	98	148	120	116	14.2	280
AX1-T101-B13	35	0.868	1.113	156	158	117	180	146	142	15.3	320
AX1-T101-B14	50	0.641	0.822	184	187	140	218	177	172	16.8	380
AX1-T101-B15	70	0.443	0.5683	225	228	174	274	223	217	18.6	475
AX1-T101-B16	95	0.32	0.4108	269	273	209	333	272	265	20.1	570
AX1-T101-B17	120	0.253	0.325	305	310	240	386	316	308	21.7	670
AX1-T101-B18	150	0.206	0.2649	341	347	273	439	362	352	23.5	790
AX1-T101-B19	185	0.164	0.2113	386	394	313	506	419	408	25.6	940
AX1-T101-B20	240	0.125	0.1617	447	456	368	599	498	485	28.1	1145
AX1-T101-B30	300	0.1	0.1301	504	515	419	689	577	561	30.9	1390
AX1-T101-B40	400	0.0778	0.1022	574	588	488	798	675	658	34.6	1760
AX1-T101-B50	500	0.0605	0.0808	652	670	563	925	788	770	38.5	2165
AX1-T101-B60	630	0.0469	0.0643	735	759	648	1064	913	895	42.6	2705
AX1-T101-B70	800	0.0367	0.0523	821	852	743	1214	1052	1035	48.4	3460
AX1-T101-B80	1000	0.0291	0.0438	903	944	838	1371	1200	1186	55.5	4265

The above data is approximate and subjected to manufacturing tolerance.

0.6/1 (1.2) KV Single Core AWA Cables

Single Core Cables, With Stranded Copper Conductors, XLPE insulation, Aluminum Wire Armoured, and PVC Sheathed.



Description

- Soft annealed copper conductor, insulated with XLPE compound rated 90 °C, Aluminum Wire Armoured and sheathed with PVC compound layer.
- Cables are produced according to IEC 60502 or BS 5467.

Application

- For outdoor and indoor installation in damp and wet locations where mechanical damages are expected to occur.

1 Core - Cu/XLPE/AWA/PVC

Product Code	Nominal Cross sectional area	Maximum Conductor Resistance		Current Rating						Approx. Overall Diameter	Approx. Weight
		DC at 20 °C	AC at 90 °C	Laid in ground			Laid in free air (Shaded)				
				Flat	Trefoil	Duct	Flat Separated	Flat Touched	Trefoil Touched		
				⊙⊙⊙	⊙⊙⊙	⊙⊙⊙	⊙⊙⊙	⊙⊙⊙	⊙⊙⊙		
mm ²	Ω/Km	Ω/Km	A	A	A	A	A	A	mm	Kg/Km	
CX1-T101-X12	25	0.727	0.9271	170	172	130	198	162	158	16.5	515
CX1-T101-X13	35	0.524	0.6684	203	206	157	240	197	192	17.6	625
CX1-T101-X14	50	0.387	0.4938	239	243	187	288	238	232	19.1	770
CX1-T101-X15	70	0.268	0.3422	291	296	230	358	297	289	20.9	1000
CX1-T101-X16	95	0.193	0.2468	345	352	275	431	360	351	22.4	1275
CX1-T101-X17	120	0.153	0.196	389	399	314	493	414	405	24	1530
CX1-T101-X18	150	0.124	0.1593	434	445	354	555	471	461	25.8	1830
CX1-T101-X19	185	0.0991	0.1279	485	500	401	628	538	529	27.9	2220
CX1-T101-X20	240	0.0754	0.0983	553	573	466	726	630	622	30.7	2810
CX1-T101-X30	300	0.0601	0.0794	614	640	528	814	717	711	33.5	3435
CX1-T101-X40	400	0.047	0.0635	673	710	593	898	809	810	37.2	4375
CX1-T101-X50	500	0.0366	0.0512	738	787	668	997	913	923	41.2	5510
CX1-T101-X60	630	0.0283	0.0418	801	864	745	1097	1019	1038	45.1	6860
CX1-T101-X70	800	0.0221	0.0349	825	905	797	1152	1088	1126	51.6	9055
CX1-T101-X80	1000	0.0176	0.0304	864	958	862	1248	1184	1235	59.1	11245

The above data is approximate and subjected to manufacturing tolerance.

0.6/1 (1.2) KV

Single Core Cables, With Stranded Aluminium Conductors, XLPE insulation, Aluminum Wire Armoured, and PVC Sheathed.



Description

- Soft annealed Aluminium conductor, insulated with XLPE compound rated 90 °C, Aluminum Wire Armoured and sheathed with PVC compound layer.
- Cables are produced according to IEC 60502.

Application

- For outdoor and indoor installation in damp and wet locations where mechanical damages are expected to occur.

1 Core - AL/XLPE/AWA/PVC

Product Code	Nominal Cross sectional area	Maximum Conductor Resistance		Current Rating						Approx. Overall Diameter	Approx. Weight
		DC at 20 °C	AC at 90 °C	Laid in ground			Laid in free air (Shaded)				
				Flat	Trefoil	Duct	Flat Separated	Flat Touched	Trefoil Touched		
				⊙⊙⊙	⊙ ⊙ ⊙	⊙ ⊙	⊙⊙⊙	⊙⊙⊙	⊙ ⊙ ⊙		
mm ²	Ω/Km	Ω/Km	A	A	A	A	A	A	mm	Kg/Km	
AX1-T101-X11	16	1.91	2.4489	103	104	78	118	96	93	15	295
AX1-T101-X12	25	1.2	1.5386	132	134	101	154	126	123	16.5	365
AX1-T101-X13	35	0.868	1.113	157	160	122	187	153	149	17.6	420
AX1-T101-X14	50	0.641	0.822	186	189	145	225	185	180	19.1	490
AX1-T101-X15	70	0.443	0.5683	227	230	179	280	231	225	20.9	595
AX1-T101-X16	95	0.32	0.4107	269	274	214	338	281	274	22.4	700
AX1-T101-X17	120	0.253	0.3249	305	311	246	389	325	317	24	805
AX1-T101-X18	150	0.206	0.2648	340	348	277	439	369	360	25.8	940
AX1-T101-X19	185	0.164	0.2112	383	393	315	501	425	415	27.9	1105
AX1-T101-X20	240	0.125	0.1616	440	453	368	585	500	491	30.6	1345
AX1-T101-X30	300	0.1	0.1299	492	509	419	663	573	564	33.4	1600
AX1-T101-X40	400	0.0778	0.102	551	574	480	749	661	655	37.2	2015
AX1-T101-X50	500	0.0605	0.0805	616	647	550	847	759	757	41.1	2445
AX1-T101-X60	630	0.0469	0.064	683	724	625	951	865	868	45	2990
AX1-T101-X70	800	0.0367	0.0518	725	782	689	1031	955	972	52	3980
AX1-T101-X80	1000	0.0291	0.0432	778	848	763	1136	1061	1089	59.1	4850

The above data is approximate and subjected to manufacturing tolerance.

0.6/1 (1.2) KV Multi Core Unarmoured Cables

Multicore Cables, with Stranded, Copper Conductors, XLPE Insulated and PVC Sheathed



Description

- Multicore cables of stranded Copper conductors are insulated with XLPE compound, assembled together and covered with an overall jacket of PVC compound.
- Cables are produced according to IEC 60502.

Application

- For outdoor and indoor installations in damp and wet locations. They are normally used for power distribution in urban networks, in industrial plants, as well as in Thermopower and Hydropower Stations.

Product Code	Nominal Cross sectional area mm ²	Maximum Conductor Resistance		Current Rating			Approx. Overall Diameter mm	Approx. Overall Diameter Kg/Km
		DC at 20 °C Ω/Km	AC at 90 °C Ω/Km	Laid in ground A	Laid in duct A	Laid in free air (Shaded) A		
2 core cables - Cu/XLPE/PVC								
CX1-T102-U04	1.5 RM	12.1	14.6	41	31	28	9.1	115
CX1-T102-U06	2.5 RM	7.41	8.87	50	39	38	10	148
CX1-T102-U08	4 RM	4.61	5.54	68	49	52	11	194
CX1-T102-U09	6 RM	3.08	3.69	86	64	67	12.2	255
CX1-T102-U10	10 RM	1.83	2.19	112	85	89	13.4	345
CX1-T102-U11	16 RM	1.15	1.39	144	102	118	15.4	500
CX1-T102-U12	25 RM	0.727	0.9272	188	133	154	18.9	675
CX1-T102-U13	35 RM	0.524	0.6685	227	162	189	21.1	880
CX1-T102-U14	50 SM	0.387	0.4938	276	193	230	20.9	1045
CX1-T102-U15	70 SM	0.268	0.3423	337	236	286	22.9	1460
CX1-T102-U16	95 SM	0.193	0.2469	405	288	357	26.6	2000
CX1-T102-U17	120 SM	0.153	0.1961	463	336	419	30.1	2485
CX1-T102-U18	150 SM	0.124	0.1593	519	378	478	32.9	3070
CX1-T102-U19	185 SM	0.0991	0.1279	590	438	560	37.5	3815
CX1-T102-U20	240 SM	0.0754	0.0982	682	513	663	41.6	4955
CX1-T102-U30	300 SM	0.0601	0.0792	767	582	757	45	6150
CX1-T102-U40	400 SM	0.047	0.0632	872	673	884	50.7	7895
3 core cables - Cu/XLPE/PVC								
CX1-T103-U04	1.5 RM	12.1	14.6	31	25	23	9.5	130
CX1-T103-U06	2.5 RM	7.41	8.87	42	33	34	10.6	175
CX1-T103-U08	4 RM	4.61	5.54	54	39	44	11.6	233
CX1-T103-U09	6 RM	3.08	3.69	68	49	53	12.9	310
CX1-T103-U10	10 RM	1.83	2.19	89	65	72	14.2	430
CX1-T103-U11	16 RM	1.15	1.39	116	82	95	16.4	625
CX1-T103-U12	25 RM	0.727	0.9273	153	110	126	20.1	895
CX1-T103-U13	35 RM	0.524	0.6686	184	132	156	22.5	1180
CX1-T103-U14	50 SM	0.387	0.494	220	157	186	22.6	1490
CX1-T103-U15	70 SM	0.268	0.3425	270	195	236	26.1	2135
CX1-T103-U16	95 SM	0.193	0.2471	324	236	290	29.4	2895
CX1-T103-U17	120 SM	0.153	0.1964	368	272	337	32.8	3605
CX1-T103-U18	150 SM	0.124	0.1597	410	307	383	35.9	4435
CX1-T103-U19	185 SM	0.0991	0.1284	464	351	441	39.9	5555
CX1-T103-U20	240 SM	0.0754	0.0988	537	414	524	45	7250
CX1-T103-U30	300 SM	0.0601	0.0799	605	471	602	49.9	9050
CX1-T103-U40	400 SM	0.047	0.0641	688	547	701	57.3	11675
CX1-T103-U50	500 SM	0.0366	0.0518	776	625	806	63.8	14945

The above data is approximate and subjected to manufacturing tolerance.

rm: Round, Stranded
sm: Sector, Stranded

» Cont'd

0.6/1 (1.2) KV Multi Core Unarmoured Cables

Multicore Cables, with Stranded, Copper Conductors, XLPE Insulated and PVC Sheathed



Product Code	Nominal Cross sectional area mm ²	Maximum Conductor Resistance		Current Rating			Approx. Overall Diameter mm	Approx. Overall Diameter Kg/Km
		DC at 20 °C Ω/Km	AC at 90 °C Ω/Km	Laid in ground	Laid in duct	Laid in free air (Shaded)		
				A	A	A		
4 core cables - Cu/XLPE/PVC								
CX1-T104-U04	1.5 RM	12.1	14.6	32	26	24	10.3	155
CX1-T104-U06	2.5 RM	7.41	8.87	43	33	35	11.4	210
CX1-T104-U08	4 RM	4.61	5.54	55	40	45	12.6	280
CX1-T104-U09	6 RM	3.08	3.69	70	50	55	14	385
CX1-T104-U10	10 RM	1.83	2.19	92	67	75	15.5	535
CX1-T104-U11	16 RM	1.15	1.39	118	84	98	17.9	790
CX1-T104-U12	25 RM	0.727	0.9273	155	112	131	22.1	1170
CX1-T104-U13	35 RM	0.524	0.6686	186	136	161	24.8	1545
CX1-T104-U14	50 SM	0.387	0.494	225	162	197	26.3	1970
CX1-T104-U15	70 SM	0.268	0.3425	276	204	249	30.4	2825
CX1-T104-U16	95 SM	0.193	0.2471	330	243	303	33.1	3825
CX1-T104-U17	120 SM	0.153	0.1964	374	282	352	37.2	4785
CX1-T104-U18	150 SM	0.124	0.1597	421	321	405	41.7	5875
CX1-T104-U19	185 SM	0.0991	0.1284	475	369	467	46.7	7395
CX1-T104-U20	240 SM	0.0754	0.0988	551	431	554	52.5	9620
CX1-T104-U30	300 SM	0.0601	0.0799	621	493	636	58.1	11995
CX1-T104-U40	400 SM	0.047	0.0641	706	571	741	66.7	15480
CX1-T104-U50	500 SM	0.0366	0.0518	797	653	851	74.2	19815
4 core cables with reduced neutral - Cu/XLPE/PVC								
CX1-T105-U12	25RM / 16RM	0.727 / 1.15	0.9273 / 1.4666	154	111	129	21.2	1075
CX1-T105-U13	35RM / 16RM	0.524 / 1.15	0.6686 / 1.4666	185	133	157	23.2	1365
CX1-T105-U14	50SM / 25RM	0.387 / 0.727	0.494 / 0.9273	226	163	198	26.1	1755
CX1-T105-U15	70SM / 35RM	0.268 / 0.524	0.3425 / 0.6686	277	204	250	30.2	2495
CX1-T105-U16	95SM / 50SM	0.193 / 0.387	0.2471 / 0.494	329	243	301	32.6	3380
CX1-T105-U17	120SM / 70SM	0.153 / 0.268	0.1964 / 0.3425	372	278	347	35.5	4290
CX1-T105-U18	150SM / 70SM	0.124 / 0.268	0.1597 / 0.3425	418	315	397	39.3	5115
CX1-T105-U19	185SM / 95SM	0.0991 / 0.193	0.1284 / 0.2471	472	363	458	44.2	6505
CX1-T105-U20	240SM / 120SM	0.0754 / 0.153	0.0988 / 0.1964	546	424	543	49.7	8415
CX1-T105-U30	300SM / 150SM	0.0601 / 0.124	0.0799 / 0.1597	615	485	624	55	10480
CX1-T105-U40	400SM / 185SM	0.047 / 0.0991	0.0641 / 0.1284	700	560	727	62.7	13460
CX1-T105-U50	500SM / 240SM	0.0366 / 0.0754	0.0518 / 0.0988	789	643	834	70.1	17300

The above data is approximate and subjected to manufacturing tolerance.

rm: Round, Stranded
sm: Sector, Stranded

0.6/1 (1.2) KV Multi Core Unarmoured Cables

Multicore Cables, with Stranded, Aluminum Conductors, XLPE Insulated and PVC Sheathed



Description

- Multicore cables of Stranded Aluminium conductors are insulated with XLPE compound, assembled together and covered with an overall jacket of PVC compound.
- Cables are produced according to IEC 60502.

Application

- For outdoor and indoor installations in damp and wet locations. They are normally used for power distribution in urban networks, in industrial plants, as well as in Thermopower and Hydropower Stations.

Product Code	Nominal Cross sectional area mm ²	Maximum Conductor Resistance		Current Rating			Approx. Overall Diameter mm	Approx. Overall Diameter Kg/Km
		DC at 20 °C	AC at 90 °C	Laid in ground	Laid in duct	Laid in free air (Shaded)		
		Ω/Km	Ω/Km	A	A	A		
2 core cables - AL/XLPE/PVC								
AX1-T102-U11	16 RM	1.91	2.4489	113	79	89	15.9	270
AX1-T102-U12	25 RM	1.2	1.5387	146	103	119	18.9	375
AX1-T102-U13	35 RM	0.868	1.1131	176	126	147	21.1	470
AX1-T102-U14	50 RM	0.641	0.8221	209	151	179	24.1	585
AX1-T102-U15	70 RM	0.443	0.5684	257	188	227	27.7	765
AX1-T102-U16	95 RM	0.32	0.4109	307	227	278	31.1	985
AX1-T102-U17	120 RM	0.253	0.3251	350	262	324	34.5	1230
AX1-T102-U18	150 RM	0.206	0.2651	392	297	370	38.3	1520
AX1-T102-U19	185 RM	0.164	0.2114	444	340	428	42.7	1865
AX1-T102-U20	240 RM	0.125	0.1618	516	402	509	48.1	2380
AX1-T102-U30	300 RM	0.1	0.1302	585	462	589	53.7	2975
AX1-T102-U40	400 RM	0.0778	0.1023	670	536	688	60.3	3785
3 core cables - AL/XLPE/PVC								
AX1-T103-U11	16 RM	1.91	2.4489	92	65	73	16.9	320
AX1-T103-U12	25 RM	1.2	1.5387	118	86	98	20.1	450
AX1-T103-U13	35 RM	0.868	1.1131	142	103	121	22.5	565
AX1-T103-U14	50 SM	0.641	0.8221	171	121	145	22.6	650
AX1-T103-U15	70 SM	0.443	0.5684	209	151	183	26.1	890
AX1-T103-U16	95 SM	0.32	0.4109	251	183	225	29.4	1150
AX1-T103-U17	120 SM	0.253	0.3252	286	211	262	32.8	1415
AX1-T103-U18	150 SM	0.206	0.2651	319	239	297	35.9	1765
AX1-T103-U19	185 SM	0.164	0.2115	361	274	344	39.9	2150
AX1-T103-U20	240 SM	0.125	0.1619	420	323	409	45	2795
AX1-T103-U30	300 SM	0.1	0.1302	474	369	471	49.9	3415
AX1-T103-U40	400 SM	0.0778	0.1023	544	433	555	57.3	4535
AX1-T103-U50	500 SM	0.0605	0.0809	621	501	645	63.8	5705

The above data is approximate and subjected to manufacturing tolerance.

rm: Round, Stranded
sm: Sector, Stranded

» Cont'd

0.6/1 (1.2) KV Multi Core Unarmoured Cables

Multicore Cables, with Stranded, Aluminum Conductors, XLPE Insulated and PVC Sheathed



Product Code	Nominal Cross sectional area mm ²	Maximum Conductor Resistance		Current Rating			Approx. Overall Diameter mm	Approx. Overall Diameter Kg/Km
		DC at 20 °C Ω/Km	AC at 90 °C Ω/Km	Laid in ground A	Laid in duct A	Laid in free air (Shaded) A		
4 core cables - AL/XLPE/PVC								
AX1-T104-U11	16 RM	1.91	2.4489	93	66	76	18.5	395
AX1-T104-U12	25 RM	1.2	1.5387	120	87	101	22.1	575
AX1-T104-U13	35 RM	0.868	1.1131	144	105	125	24.8	730
AX1-T104-U14	50 SM	0.641	0.8221	175	126	153	26.3	850
AX1-T104-U15	70 SM	0.443	0.5684	215	158	194	30.4	1160
AX1-T104-U16	95 SM	0.32	0.4109	256	189	235	33.1	1500
AX1-T104-U17	120 SM	0.253	0.3252	291	219	274	37.2	1860
AX1-T104-U18	150 SM	0.206	0.2651	327	249	314	41.7	2315
AX1-T104-U19	185 SM	0.164	0.2115	370	287	364	46.7	2850
AX1-T104-U20	240 SM	0.125	0.1619	430	337	432	52.5	3670
AX1-T104-U30	300 SM	0.1	0.1302	486	386	498	58.1	4500
AX1-T104-U40	400 SM	0.0778	0.1023	558	452	586	66.7	5960
AX1-T104-U50	500 SM	0.0605	0.0809	638	522	681	74.2	7485
4 core cables with reduced neutral - AL/XLPE/PVC								
AX1-T105-U12	25RM/16RM	1.2 / 1.91	1.5387 / 2.4489	119	86	100	21.2	530
AX1-T105-U13	35RM/16RM	0.868 / 1.91	1.1131 / 2.4489	143	103	122	23.2	655
AX1-T105-U14	50SM/25RM	0.641 / 1.2	0.8221 / 1.5387	175	126	153	26.1	765
AX1-T105-U15	70SM/35RM	0.443 / 0.868	0.5684 / 1.1131	215	158	194	30.2	1040
AX1-T105-U16	95SM/50SM	0.32 / 0.641	0.4109 / 0.8221	255	188	233	32.6	1350
AX1-T105-U17	120SM/70SM	0.253 / 0.443	0.3252 / 0.5684	289	216	270	35.5	1675
AX1-T105-U18	150SM/70SM	0.206 / 0.443	0.2651 / 0.5684	324	245	308	39.3	2030
AX1-T105-U19	185SM/95SM	0.164 / 0.32	0.2115 / 0.4109	367	283	357	44.2	2515
AX1-T105-U20	240SM/120SM	0.125 / 0.253	0.1619 / 0.3252	427	332	424	49.7	3230
AX1-T105-U30	300SM/150SM	0.1 / 0.206	0.1302 / 0.2651	482	380	489	55	3980
AX1-T105-U40	400SM/185SM	0.0778 / 0.164	0.1023 / 0.2115	554	443	575	62.7	5185
AX1-T105-U50	500SM/240SM	0.0605 / 0.125	0.0809 / 0.1619	632	515	668	70.1	6580

The above data is approximate and subjected to manufacturing tolerance.

rm: Round, Stranded
sm: Sector, Stranded

0.6/1 (1.2) KV Multi Core STA Cables

Multicore Cables, with Stranded Copper Conductors, XLPE Insulated, Steel Tape Armoured and PVC Sheathed



Description

- Multicore cables of stranded Copper conductors are insulated with XLPE compound, assembled together, armoured with steel tape and covered with an overall jacket of PVC compound.
- Cables are produced according to IEC 60502.

Application

- For outdoor installations in damp wet locations where mechanical damages are expected to occur.

Product Code	Nominal Cross sectional area mm ²	Maximum Conductor Resistance		Current Rating			Approx. Overall Diameter mm	Approx. Overall Diameter Kg/Km
		DC at 20 °C Ω/Km	AC at 90 °C Ω/Km	Laid in ground	Laid in duct	Laid in free air (Shaded)		
				A	A	A		
2 core cables - CU/XLPE/STA/PVC								
CX1-T102-G09	6 RM	3.08	3.69	84	64	68	15	405
CX1-T102-G10	10 RM	1.83	2.19	110	85	90	16.2	510
CX1-T102-G11	16 RM	1.15	1.39	142	103	118	18.2	680
CX1-T102-G12	25 RM	0.727	0.9272	185	135	155	21.1	865
CX1-T102-G13	35 RM	0.524	0.6685	224	162	191	23.3	1090
CX1-T102-G14	50 SM	0.387	0.4938	272	193	231	22.9	1235
CX1-T102-G15	70 SM	0.268	0.3423	330	237	286	25.1	1675
CX1-T102-G16	95 SM	0.193	0.2469	397	289	355	29	2265
CX1-T102-G17	120 SM	0.153	0.1961	457	339	422	33.7	3085
CX1-T102-G18	150 SM	0.124	0.1593	512	381	480	36.5	3695
CX1-T102-G19	185 SM	0.0991	0.1279	580	440	559	41.5	4595
CX1-T102-G20	240 SM	0.0754	0.0982	670	513	658	45.6	5805
CX1-T102-G30	300 SM	0.0601	0.0792	751	580	749	49	7070
CX1-T102-G40	400 SM	0.047	0.0632	853	669	871	54.7	8925
3 core cables - CU/XLPE/STA/PVC								
CX1-T103-G09	6 RM	3.08	3.69	67	49	53	15.8	475
CX1-T103-G10	10 RM	1.83	2.19	88	66	73	17.1	605
CX1-T103-G11	16 RM	1.15	1.39	114	82	95	19.3	830
CX1-T103-G12	25 RM	0.727	0.9273	151	110	128	22.3	1120
CX1-T103-G13	35 RM	0.524	0.6686	182	134	157	24.7	1435
CX1-T103-G14	50 SM	0.387	0.494	217	158	187	24.6	1700
CX1-T103-G15	70 SM	0.268	0.3425	265	196	235	28.5	2390
CX1-T103-G16	95 SM	0.193	0.2471	317	237	288	32	3205
CX1-T103-G17	120 SM	0.153	0.1964	363	274	339	36.6	4280
CX1-T103-G18	150 SM	0.124	0.1597	404	309	383	39.9	5195
CX1-T103-G19	185 SM	0.0991	0.1284	456	355	440	43.9	6385
CX1-T103-G20	240 SM	0.0754	0.0988	528	414	519	49.2	8195
CX1-T103-G30	300 SM	0.0601	0.0799	595	473	596	53.9	10075
CX1-T103-G40	400 SM	0.047	0.0641	676	545	693	61.1	12810
CX1-T103-G50	500 SM	0.0366	0.0518	760	620	792	67.8	16245

The above data is approximate and subjected to manufacturing tolerance.

rm: Round, Stranded
sm: Sector, Stranded

» Cont'd

0.6/1 (1.2) KV Multi Core STA Cables

Multicore Cables, with Stranded Copper Conductors, XLPE Insulated, Steel Tape Armoured and PVC Sheathed



Product Code	Nominal Cross sectional area mm ²	Maximum Conductor Resistance		Current Rating			Approx. Overall Diameter mm	Approx. Overall Diameter Kg/Km
		DC at 20 °C Ω/Km	AC at 90 °C Ω/Km	Laid in ground A	Laid in duct A	Laid in free air (Shaded) A		
4 core cables - CU/XLPE/STA/PVC								
CX1-T104-G09	6 RM	3.08	3.69	67	50	55	17	555
CX1-T104-G10	10 RM	1.83	2.19	89	67	75	18.4	725
CX1-T104-G11	16 RM	1.15	1.39	116	84	98	20.8	1005
CX1-T104-G12	25 RM	0.727	0.9273	153	113	131	24.3	1390
CX1-T104-G13	35 RM	0.524	0.6686	184	137	162	27	1795
CX1-T104-G14	50 SM	0.387	0.494	222	164	197	28.3	2210
CX1-T104-G15	70 SM	0.268	0.3425	272	203	248	32.8	3125
CX1-T104-G16	95 SM	0.193	0.2471	325	247	304	36.9	4510
CX1-T104-G17	120 SM	0.153	0.1964	369	284	352	41.2	5575
CX1-T104-G18	150 SM	0.124	0.1597	415	322	404	45.7	6755
CX1-T104-G19	185 SM	0.0991	0.1284	469	370	465	50.7	8365
CX1-T104-G20	240 SM	0.0754	0.0988	543	431	549	56.5	10700
CX1-T104-G30	300 SM	0.0601	0.0799	611	492	629	62.1	13190
CX1-T104-G40	400 SM	0.047	0.0641	694	568	730	70.9	16885
CX1-T104-G50	500 SM	0.0366	0.0518	784	649	840	79.8	22155
4 core cables with reduced neutral - CU/XLPE/STA/PVC								
CX1-T105-G12	25RM/16RM	0.727 / 1.15	0.9273 / 1.4666	152	112	130	23.4	1285
CX1-T105-G13	35RM/16RM	0.524 / 1.15	0.6686 / 1.4666	182	135	158	25.4	1595
CX1-T105-G14	50SM/25RM	0.387 / 0.727	0.494 / 0.9273	223	164	198	28.3	2035
CX1-T105-G15	70SM/35RM	0.268 / 0.524	0.3425 / 0.6686	272	203	249	33	2865
CX1-T105-G16	95SM/50SM	0.193 / 0.387	0.2471 / 0.494	325	245	303	36.2	4035
CX1-T105-G17	120SM/70SM	0.153 / 0.268	0.1964 / 0.3425	368	280	348	39.1	5000
CX1-T105-G18	150SM/70SM	0.124 / 0.268	0.1597 / 0.3425	411	317	396	43.3	5945
CX1-T105-G19	185SM/95SM	0.0991 / 0.193	0.1284 / 0.2471	465	364	456	48.2	7425
CX1-T105-G20	240SM/120SM	0.0754 / 0.153	0.0988 / 0.1964	538	427	539	53.7	9440
CX1-T105-G30	300SM/150SM	0.0601 / 0.124	0.0799 / 0.1597	607	485	618	58.8	11580
CX1-T105-G40	400SM/185SM	0.047 / 0.0991	0.0641 / 0.1284	688	560	717	66.7	14745
CX1-T105-G50	500SM/240SM	0.0366 / 0.0754	0.0518 / 0.0988	775	638	821	74.1	18735

The above data is approximate and subjected to manufacturing tolerance.

rm: Round, Stranded
sm: Sector, Stranded

0.6/1 (1.2) KV Multi Core STA Cables

Multicore Cables, with Stranded Aluminium Conductors, XLPE Insulated, Steel Tape Armoured and PVC Sheathed



Description

- Multicore cables of stranded Aluminium conductors are insulated with XLPE compound, assembled together, armoured with steel tape and covered with an overall jacket of PVC compound.
- Cables are produced according to IEC 60502.

Application

- For outdoor installations in damp wet locations where mechanical damages are expected to occur.

Product Code	Nominal Cross sectional area mm ²	Maximum Conductor Resistance		Current Rating			Approx. Overall Diameter mm	Approx. Overall Diameter Kg/Km
		DC at 20 °C Ω/Km	AC at 90 °C Ω/Km	Laid in ground A	Laid in duct A	Laid in free air (Shaded) A		
2 core cables - AL/XLPE/STA/PVC								
AX1-T102-G11	16 RM	1.91	2.4489	111	80	90	18.1	430
AX1-T102-G12	25 RM	1.2	1.5387	144	105	120	21.1	565
AX1-T102-G13	35 RM	0.868	1.1131	173	126	148	23.3	680
AX1-T102-G14	50 RM	0.641	0.8221	206	151	180	26.3	830
AX1-T102-G15	70 RM	0.443	0.5684	254	189	227	30.1	1060
AX1-T102-G16	95 RM	0.32	0.4109	303	229	278	33.7	1330
AX1-T102-G17	120 RM	0.253	0.3251	347	265	326	38.3	1955
AX1-T102-G18	150 RM	0.206	0.2651	388	299	371	42.1	2325
AX1-T102-G19	185 RM	0.164	0.2114	439	344	428	46.9	2810
AX1-T102-G20	240 RM	0.125	0.1618	510	403	507	52.3	3440
AX1-T102-G30	300 RM	0.1	0.1302	577	462	585	57.9	4155
AX1-T102-G40	400 RM	0.0778	0.1023	660	535	681	64.5	5100
3 core cables - AL/XLPE/STA/PVC								
AX1-T103-G11	16 RM	1.91	2.4489	91	65	74	19.1	500
AX1-T103-G12	25 RM	1.2	1.5387	117	86	99	22.3	675
AX1-T103-G13	35 RM	0.868	1.1131	141	104	121	24.7	820
AX1-T103-G14	50 SM	0.641	0.8221	168	123	145	24.6	855
AX1-T103-G15	70 SM	0.443	0.5684	206	152	182	28.5	1145
AX1-T103-G16	95 SM	0.32	0.4109	246	184	224	32	1460
AX1-T103-G17	120 SM	0.253	0.3252	282	213	263	36.6	2090
AX1-T103-G18	150 SM	0.206	0.2651	314	240	297	39.9	2525
AX1-T103-G19	185 SM	0.164	0.2115	356	277	343	43.9	2980
AX1-T103-G20	240 SM	0.125	0.1619	413	324	406	49.2	3745
AX1-T103-G30	300 SM	0.1	0.1302	467	372	468	53.9	4440
AX1-T103-G40	400 SM	0.0778	0.1023	537	432	550	61.1	5670
AX1-T103-G50	500 SM	0.0605	0.0809	611	498	637	67.8	7005

The above data is approximate and subjected to manufacturing tolerance.

rm: Round, Stranded
sm: Sector, Stranded

» Cont'd

0.6/1 (1.2) KV Multi Core STA Cables

Multicore Cables, with Stranded Aluminium Conductors, XLPE Insulated, Steel Tape Armoured and PVC Sheathed



Product Code	Nominal Cross sectional area mm ²	Maximum Conductor Resistance		Current Rating			Approx. Overall Diameter mm	Approx. Overall Diameter Kg/Km
		DC at 20 °C Ω/Km	AC at 90 °C Ω/Km	Laid in ground	Laid in duct	Laid in free air (Shaded)		
				A	A	A		
4 core cables - AL/XLPE/STA/PVC								
AX1-T104-G11	16 RM	1.91	2.4489	92	67	77	20.7	580
AX1-T104-G12	25 RM	1.2	1.5387	119	88	102	24.3	795
AX1-T104-G13	35 RM	0.868	1.1131	143	106	125	27	975
AX1-T104-G14	50 SM	0.641	0.8221	172	127	153	28.3	1090
AX1-T104-G15	70 SM	0.443	0.5684	211	158	193	32.8	1465
AX1-T104-G16	95 SM	0.32	0.4109	252	192	236	36.9	2180
AX1-T104-G17	120 SM	0.253	0.3252	287	221	274	41.2	2650
AX1-T104-G18	150 SM	0.206	0.2651	322	250	314	45.7	3195
AX1-T104-G19	185 SM	0.164	0.2115	366	288	362	50.7	3820
AX1-T104-G20	240 SM	0.125	0.1619	425	338	429	56.5	4755
AX1-T104-G30	300 SM	0.1	0.1302	480	386	494	62.1	5695
AX1-T104-G40	400 SM	0.0778	0.1023	550	451	579	70.9	7365
AX1-T104-G50	500 SM	0.0605	0.0809	629	521	674	79.8	9820
4 core cables with reduced neutral - AL/XLPE/STA/PVC								
AX1-T105-G12	25RM/16RM	1.2 / 1.91	1.5387 / 2.4489	118	87	101	23.4	745
AX1-T105-G13	35RM/16RM	0.868 / 1.91	1.1131 / 2.4489	141	104	123	25.4	885
AX1-T105-G14	50SM/25RM	0.641 / 1.2	0.8221 / 1.5387	173	127	154	28.3	1050
AX1-T105-G15	70SM/35RM	0.443 / 0.868	0.5684 / 1.1131	211	158	193	33	1410
AX1-T105-G16	95SM/50SM	0.32 / 0.641	0.4109 / 0.8221	252	190	235	36.2	2005
AX1-T105-G17	120SM/70SM	0.253 / 0.443	0.3252 / 0.5684	286	218	271	39.1	2390
AX1-T105-G18	150SM/70SM	0.206 / 0.443	0.2651 / 0.5684	320	246	308	43.3	2860
AX1-T105-G19	185SM/95SM	0.164 / 0.32	0.2115 / 0.4109	362	284	356	48.2	3435
AX1-T105-G20	240SM/120SM	0.125 / 0.253	0.1619 / 0.3252	421	334	422	53.7	4255
AX1-T105-G30	300SM/150SM	0.1 / 0.206	0.1302 / 0.2651	476	381	485	58.8	5085
AX1-T105-G40	400SM/185SM	0.0778 / 0.164	0.1023 / 0.2115	546	445	569	66.7	6470
AX1-T105-G50	500SM/240SM	0.0605 / 0.125	0.0809 / 0.1619	622	512	659	74.1	8010

The above data is approximate and subjected to manufacturing tolerance.

rm: Round, Stranded
sm: Sector, Stranded

0.6/1 (1.2) KV Multi Core SWA Cables

Multicore Cables, with Stranded Copper Conductors, XLPE Insulated, Steel Wire Armoured and PVC Sheathed



Description

- Multicore cables of stranded Copper conductors are insulated with XLPE compound, assembled together, armoured with steel wires and covered with an overall jacket of PVC compound.
- Cables are produced according to IEC 60502 or BS 5467.

Application

- For outdoor installations in damp wet locations where mechanical damages are expected to occur.

Product Code	Nominal Cross sectional area mm ²	Maximum Conductor Resistance		Current Rating			Approx. Overall Diameter mm	Approx. Overall Diameter Kg/Km
		DC at 20 °C Ω/Km	AC at 90 °C Ω/Km	Laid in ground A	Laid in duct A	Laid in free air (Shaded) A		
2 core cables - CU/XLPE/SWA/PVC								
CX1-T102-W08	4 RM	4.61	5.54	68	52	55	14.6	410
CX1-T102-W09	6 RM	3.08	3.69	86	67	71	15.8	500
CX1-T102-W10	10 RM	1.83	2.19	111	88	93	17.7	700
CX1-T102-W11	16 RM	1.15	1.39	143	106	123	19.8	900
CX1-T102-W12	25 RM	0.727	0.9272	187	139	161	24.4	1335
CX1-T102-W13	35 RM	0.524	0.6685	226	166	198	26.6	1620
CX1-T102-W14	50 SM	0.387	0.4938	274	198	240	26.2	1750
CX1-T102-W15	70 SM	0.268	0.3423	332	243	296	28.6	2255
CX1-T102-W16	95 SM	0.193	0.2469	402	297	369	32.9	3105
CX1-T102-W17	120 SM	0.153	0.1961	458	341	430	36.4	3735
CX1-T102-W18	150 SM	0.124	0.1593	512	385	488	39	4365
CX1-T102-W19	185 SM	0.0991	0.1279	580	444	569	45.2	5790
CX1-T102-W20	240 SM	0.0754	0.0982	667	515	666	49.3	7105
CX1-T102-W30	300 SM	0.0601	0.0792	746	580	756	52.5	8455
CX1-T102-W40	400 SM	0.047	0.0632	839	662	868	58.4	10495
3 core cables - CU/XLPE/SWA/PVC								
CX1-T103-W08	4 RM	4.61	5.54	54	41	46	15.3	465
CX1-T103-W09	6 RM	3.08	3.69	67	51	56	16.6	570
CX1-T103-W10	10 RM	1.83	2.19	88	68	76	18.5	810
CX1-T103-W11	16 RM	1.15	1.39	114	84	99	20.7	1065
CX1-T103-W12	25 RM	0.727	0.9273	152	113	132	25.6	1620
CX1-T103-W13	35 RM	0.524	0.6686	183	137	162	28	1990
CX1-T103-W14	50 SM	0.387	0.494	218	162	193	28.1	2265
CX1-T103-W15	70 SM	0.268	0.3425	268	201	244	32.4	3205
CX1-T103-W16	95 SM	0.193	0.2471	321	243	298	35.9	4135
CX1-T103-W17	120 SM	0.153	0.1964	365	279	345	39.1	4945
CX1-T103-W18	150 SM	0.124	0.1597	406	316	391	43.6	6330
CX1-T103-W19	185 SM	0.0991	0.1284	457	359	447	47.6	7625
CX1-T103-W20	240 SM	0.0754	0.0988	527	417	526	52.7	9580
CX1-T103-W30	300 SM	0.0601	0.0799	590	472	599	57.6	11615
CX1-T103-W40	400 SM	0.047	0.0641	665	539	689	64.8	14570
CX1-T103-W50	500 SM	0.0366	0.0518	736	603	779	73	19020

The above data is approximate and subjected to manufacturing tolerance.

rm: Round, Stranded
sm: Sector, Stranded

» Cont'd

0.6/1 (1.2) KV Multi Core SWA Cables

Multicore Cables, with Stranded Copper Conductors, XLPE Insulated, Steel Wire Armoured and PVC Sheathed



Product Code	Nominal Cross sectional area	Maximum Conductor Resistance		Current Rating			Approx. Overall Diameter	Approx. Overall Diameter
		DC at 20 °C	AC at 90 °C	Laid in ground	Laid in duct	Laid in free air (Shaded)		
	mm ²	Ω/Km	Ω/Km	A	A	A	mm	Kg/Km
4 core cables - CU/XLPE/SWA/PVC								
CX1-T104-W08	4 RM	4.61	5.54	54	42	47	16.3	535
CX1-T104-W09	6 RM	3.08	3.69	68	52	57	18.4	765
CX1-T104-W10	10 RM	1.83	2.19	90	69	77	19.8	950
CX1-T104-W11	16 RM	1.15	1.39	115	86	101	23	1390
CX1-T104-W12	25 RM	0.727	0.9273	154	116	136	27.6	1945
CX1-T104-W13	35 RM	0.524	0.6686	185	140	166	30.5	2435
CX1-T104-W14	50 SM	0.387	0.494	224	168	203	31.8	2860
CX1-T104-W15	70 SM	0.268	0.3425	274	209	256	36.9	4095
CX1-T104-W16	95 SM	0.193	0.2471	327	249	310	39.4	5195
CX1-T104-W17	120 SM	0.153	0.1964	371	288	359	44.9	6770
CX1-T104-W18	150 SM	0.124	0.1597	416	326	410	49.4	8090
CX1-T104-W19	185 SM	0.0991	0.1284	468	372	470	54.2	9805
CX1-T104-W20	240 SM	0.0754	0.0988	538	433	551	60.2	12320
CX1-T104-W30	300 SM	0.0601	0.0799	602	487	627	65.8	14975
CX1-T104-W40	400 SM	0.047	0.0641	673	554	719	75.9	19775
CX1-T104-W50	500 SM	0.0366	0.0518	748	623	813	83.4	24540
4 core cables with reduced neutral - CU/XLPE/SWA/PVC								
CX1-T105-W12	25RM / 16RM	0.727 / 1.15	0.9273 / 1.4666	153	115	134	26.7	1815
CX1-T105-W13	35RM / 16RM	0.524 / 1.15	0.6686 / 1.4666	184	138	163	28.7	2180
CX1-T105-W14	50SM / 25RM	0.387 / 0.727	0.494 / 0.9273	225	168	204	31.8	2700
CX1-T105-W15	70SM / 35RM	0.268 / 0.524	0.3425 / 0.6686	275	210	257	36.9	3835
CX1-T105-W16	95SM / 50SM	0.193 / 0.387	0.2471 / 0.494	326	249	308	38.9	4720
CX1-T105-W17	120SM / 70SM	0.153 / 0.268	0.1964 / 0.3425	369	284	354	41.8	5750
CX1-T105-W18	150SM / 70SM	0.124 / 0.268	0.1597 / 0.3425	413	323	403	47	7190
CX1-T105-W19	185SM / 95SM	0.0991 / 0.193	0.1284 / 0.2471	464	367	462	51.9	8805
CX1-T105-W20	240SM / 120SM	0.0754 / 0.153	0.0988 / 0.1964	535	428	542	57.4	10975
CX1-T105-W30	300SM / 150SM	0.0601 / 0.124	0.0799 / 0.1597	599	482	618	62.5	13285
CX1-T105-W40	400SM / 185SM	0.047 / 0.0991	0.0641 / 0.1284	671	548	710	71.5	17405
CX1-T105-W50	500SM / 240SM	0.0366 / 0.0754	0.0518 / 0.0988	743	614	800	79.3	21805

The above data is approximate and subjected to manufacturing tolerance.

rm: Round, Stranded
sm: Sector, Stranded

0.6/1 (1.2) KV Multi Core SWA Cables

Multicore Cables, with Stranded, Aluminium Conductors, XLPE Insulated, Steel Wire Armoured and PVC Sheathed



Description

- Multicore cables of stranded Aluminium conductors are insulated with XLPE compound, assembled together, armoured with steel wire and covered with an overall jacket of PVC compound.
- Cables are produced according to IEC 60502.

Application

- For outdoor installations in damp wet locations where mechanical damages are expected to occur.

Product Code	Nominal Cross sectional area mm ²	Maximum Conductor Resistance		Current Rating			Approx. Overall Diameter mm	Approx. Overall Diameter Kg/Km
		DC at 20 °C Ω/Km	AC at 90 °C Ω/Km	Laid in ground A	Laid in duct A	Laid in free air (Shaded) A		
2 core cables - AL/XLPE/SWA/PVC								
AX1-T102-W11	16 RM	1.91	2.4489	113	82	94	20.3	695
AX1-T102-W12	25 RM	1.2	1.5387	146	108	125	24.4	1035
AX1-T102-W13	35 RM	0.868	1.1131	175	129	153	26.6	1210
AX1-T102-W14	50 RM	0.641	0.8221	208	155	186	29.6	1420
AX1-T102-W15	70 RM	0.443	0.5684	255	193	233	33.6	1765
AX1-T102-W16	95 RM	0.32	0.4109	306	233	286	37.6	2325
AX1-T102-W17	120 RM	0.253	0.3251	348	268	331	41	2690
AX1-T102-W18	150 RM	0.206	0.2651	389	302	376	44.6	3105
AX1-T102-W19	185 RM	0.164	0.2114	439	347	434	50.6	4160
AX1-T102-W20	240 RM	0.125	0.1618	509	405	512	56	4955
AX1-T102-W30	300 RM	0.1	0.1302	574	462	588	61.4	5800
AX1-T102-W40	400 RM	0.0778	0.1023	652	531	680	68.2	6965
3 core cables - AL/XLPE/SWA/PVC								
AX1-T103-W11	16 RM	1.91	2.4489	92	67	77	21.3	780
AX1-T103-W12	25 RM	1.2	1.5387	118	88	103	25.6	1170
AX1-T103-W13	35 RM	0.868	1.1131	142	106	125	28	1375
AX1-T103-W14	50 SM	0.641	0.8221	169	126	150	28.1	1420
AX1-T103-W15	70 SM	0.443	0.5684	208	156	190	32.4	1960
AX1-T103-W16	95 SM	0.32	0.4109	249	189	231	35.9	2385
AX1-T103-W17	120 SM	0.253	0.3252	284	217	269	39.1	2755
AX1-T103-W18	150 SM	0.206	0.2651	316	246	304	43.6	3660
AX1-T103-W19	185 SM	0.164	0.2115	358	281	350	47.6	4220
AX1-T103-W20	240 SM	0.125	0.1619	414	328	413	52.7	5125
AX1-T103-W30	300 SM	0.1	0.1302	466	373	473	57.6	5980
AX1-T103-W40	400 SM	0.0778	0.1023	532	431	551	64.8	7430
AX1-T103-W50	500 SM	0.0605	0.0809	600	492	633	73	9780

The above data is approximate and subjected to manufacturing tolerance.

rm: Round, Stranded
sm: Sector, Stranded

» Cont'd

0.6/1 (1.2) KV Multi Core SWA Cables

Multicore Cables, with Stranded, Aluminium Conductors, XLPE Insulated, Steel Wire Armoured and PVC Sheathed



Product Code	Nominal Cross sectional area mm ²	Maximum Conductor Resistance		Current Rating			Approx. Overall Diameter mm	Approx. Overall Diameter Kg/Km
		DC at 20 °C Ω/Km	AC at 90 °C Ω/Km	Laid in ground A	Laid in duct A	Laid in free air (Shaded) A		
4 core cables - AL/XLPE/SWA/PVC								
AX1-T104-W11	16 RM	1.91	2.4489	93	69	80	24	1040
AX1-T104-W12	25 RM	1.2	1.5387	120	90	105	27.6	1350
AX1-T104-W13	35 RM	0.868	1.1131	144	109	129	30.5	1615
AX1-T104-W14	50 SM	0.641	0.8221	174	130	157	31.8	1740
AX1-T104-W15	70 SM	0.443	0.5684	213	163	199	36.9	2430
AX1-T104-W16	95 SM	0.32	0.4109	254	194	241	39.4	2870
AX1-T104-W17	120 SM	0.253	0.3252	289	225	280	44.9	3850
AX1-T104-W18	150 SM	0.206	0.2651	324	254	320	49.4	4530
AX1-T104-W19	185 SM	0.164	0.2115	367	291	368	54.2	5260
AX1-T104-W20	240 SM	0.125	0.1619	424	341	433	60.2	6375
AX1-T104-W30	300 SM	0.1	0.1302	477	386	496	65.8	7480
AX1-T104-W40	400 SM	0.0778	0.1023	542	446	577	75.9	10255
AX1-T104-W50	500 SM	0.0605	0.0809	611	510	663	83.4	12205
4 core cables with reduced neutral - AL/XLPE/SWA/PVC								
AX1-T105-W12	25RM/16RM	1.2 / 1.91	1.5387 / 2.4489	119	89	104	26.7	1270
AX1-T105-W13	35RM/16RM	0.868 / 1.91	1.1131 / 2.4489	143	107	127	28.7	1470
AX1-T105-W14	50SM/25RM	0.641 / 1.2	0.8221 / 1.5387	174	130	158	31.8	1710
AX1-T105-W15	70SM/35RM	0.443 / 0.868	0.5684 / 1.1131	214	163	200	36.9	2385
AX1-T105-W16	95SM/50SM	0.32 / 0.641	0.4109 / 0.8221	254	193	239	38.9	2695
AX1-T105-W17	120SM/70SM	0.253 / 0.443	0.3252 / 0.5684	288	221	275	41.8	3140
AX1-T105-W18	150SM/70SM	0.206 / 0.443	0.2651 / 0.5684	321	252	314	47	4105
AX1-T105-W19	185SM/95SM	0.164 / 0.32	0.2115 / 0.4109	363	287	362	51.9	4815
AX1-T105-W20	240SM/120SM	0.125 / 0.253	0.1619 / 0.3252	421	336	426	57.4	5790
AX1-T105-W30	300SM/150SM	0.1 / 0.206	0.1302 / 0.2651	474	381	488	62.5	6790
AX1-T105-W40	400SM/185SM	0.0778 / 0.164	0.1023 / 0.2115	539	441	570	71.5	9130
AX1-T105-W50	500SM/240SM	0.0605 / 0.125	0.0809 / 0.1619	607	502	652	79.3	11080

The above data is approximate and subjected to manufacturing tolerance.

rm: Round, Stranded
sm: Sector, Stranded

1.8/3 (3.6) KV Single Core Unarmoured Cables

Single Core Cables, with stranded Circular copper or Aluminum conductors, PVC insulated, copper tape shield and PVC Sheath



Description

- Soft stranded copper or aluminum conductor, insulated with PVC compound rated 70 °C Shielded with copper tape and sheathed with PVC compound layer.
- Cable are produced according to IEC 60502.

Application

- For outdoor and indoor installation in damp and wet locations. They are normally used for power distribution in urban networks, industrial plants, as well as in the thermopower and hydropower stations.

Product Code	Nominal Cross sectional area	Maximum Conductor Resistance		Current Rating						Approx. Overall Diameter	Approx. Weight
		DC at 20 °C	AC at 70 °C	Laid in ground			Laid in free air (Shaded)				
				Flat	Trefoil	Duct	Flat Separated	Flat Touched	Trefoil Touched		
mm ²	Ω/Km	Ω/Km	A	A	A	A	A	A	mm	Kg/Km	
1 Core - Cu/PVC/PVC											
CPA-T101-U12	25	0.727	0.87	141	143	105	145	117	114	13	410
CPA-T101-U13	35	0.524	0.6272	170	172	127	178	144	140	14.1	515
CPA-T101-U14	50	0.387	0.4634	201	204	151	216	175	171	15.6	650
CPA-T101-U15	70	0.268	0.3213	246	250	187	272	221	215	17.2	860
CPA-T101-U16	95	0.193	0.2318	295	299	226	332	271	263	18.9	1130
CPA-T101-U17	120	0.153	0.1843	335	340	259	385	315	306	20.3	1380
CPA-T101-U18	150	0.124	0.1499	376	382	293	440	360	350	21.9	1660
CPA-T101-U19	185	0.0991	0.1206	424	431	334	508	416	404	23.6	2010
CPA-T101-U20	240	0.0754	0.093	491	499	390	604	496	481	26.2	2575
CPA-T101-U30	300	0.0601	0.0754	552	562	447	697	574	557	29.2	3195
CPA-T101-U40	400	0.047	0.0607	623	635	512	807	665	646	32.4	4070
CPA-T101-U50	500	0.0366	0.0494	700	716	588	936	771	750	36.4	5185
CPA-T101-U60	630	0.0283	0.0409	780	799	664	1079	882	859	40.1	6500
CPA-T101-U70	800	0.0221	0.0349	856	879	742	1231	998	972	44.6	8390
CPA-T101-U80	1000	0.0176	0.0307	930	959	830	1396	1129	1102	52.1	10495
1 Core - AL/PVC/PVC											
APA-T101-U11	16	1.91	2.2949	85	86	62	85	69	67	11.9	215
APA-T101-U12	25	1.2	1.4419	110	111	81	113	91	89	13	260
APA-T101-U13	35	0.868	1.0431	132	133	98	138	112	109	14.1	310
APA-T101-U14	50	0.641	0.7704	156	158	118	168	136	132	15.6	370
APA-T101-U15	70	0.443	0.5326	191	194	145	211	172	167	17.2	455
APA-T101-U16	95	0.32	0.385	229	232	175	258	210	205	18.9	555
APA-T101-U17	120	0.253	0.3047	261	265	202	300	245	238	20.3	655
APA-T101-U18	150	0.206	0.2485	292	297	228	342	280	272	21.9	765
APA-T101-U19	185	0.164	0.1983	331	337	261	396	325	315	23.6	895
APA-T101-U20	240	0.125	0.1519	384	391	306	472	388	376	26.1	1110
APA-T101-U30	300	0.1	0.1223	434	442	351	545	451	438	29.1	1365
APA-T101-U40	400	0.0778	0.0963	496	505	407	638	529	514	32.4	1710
APA-T101-U50	500	0.0605	0.0764	565	577	474	747	622	604	36.3	2120
APA-T101-U60	630	0.0469	0.0611	640	655	544	872	724	703	40	2630
APA-T101-U70	800	0.0367	0.0502	719	737	625	1016	840	817	45	3300
APA-T101-U80	1000	0.0291	0.0424	797	819	709	1171	966	941	52.1	4100

The above data is approximate and subjected to manufacturing tolerance.

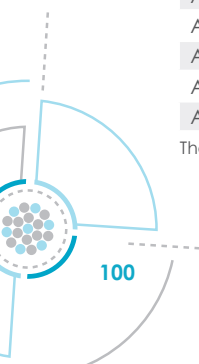

1.8/3 (3.6) KV Single Core ATA Cables

Single Core Cables, With Stranded Copper or Aluminum Conductors, PVC insulation, Aluminum Tape Armoured, and PVC Sheathed.



Description

- Soft annealed copper or Aluminum conductor, insulated with PVC compound rated 70 °C, Aluminum Tape Armoured and sheathed with PVC compound layer.
- Cables are produced according to IEC 60502.

Application

- For outdoor and indoor installation in damp and wet locations where mechanical damages are expected to occur.

Product Code	Nominal Cross sectional area	Maximum Conductor Resistance		Current Rating						Approx. Overall Diameter	Approx. Weight
		DC at 20 °C	AC at 70 °C	Laid in ground			Laid in free air (Shaded)				
				Flat	Trefoil	Duct	Flat Separated	Flat Touched	Trefoil Touched		
				⊙⊙⊙	⊙⊙⊙	⊙⊙⊙	⊙⊙⊙	⊙⊙⊙	⊙⊙⊙		
mm ²	Ω/Km	Ω/Km	A	A	A	A	A	A	mm	Kg/Km	
1 Core - Cu/PVC/ATA/PVC											
CPA-T101-B12	25	0.727	0.87	142	144	109	150	125	122	16.8	535
CPA-T101-B13	35	0.524	0.6272	170	172	132	183	153	149	17.9	650
CPA-T101-B14	50	0.387	0.4634	202	205	157	222	185	180	19.2	785
CPA-T101-B15	70	0.268	0.3212	247	251	193	277	231	225	20.8	1010
CPA-T101-B16	95	0.193	0.2317	295	300	233	337	282	274	22.3	1280
CPA-T101-B17	120	0.153	0.1841	335	340	266	389	325	317	23.7	1540
CPA-T101-B18	150	0.124	0.1497	375	382	300	442	371	361	25.1	1820
CPA-T101-B19	185	0.0991	0.1203	423	431	341	507	426	415	26.8	2185
CPA-T101-B20	240	0.0754	0.0926	487	498	397	598	504	492	29.4	2765
CPA-T101-B30	300	0.0601	0.075	546	560	453	683	579	566	32.2	3385
CPA-T101-B40	400	0.047	0.0601	613	631	520	778	667	654	36	4330
CPA-T101-B50	500	0.0366	0.0488	685	708	591	887	766	754	40	5475
CPA-T101-B60	630	0.0283	0.0402	757	788	667	1004	870	859	43.5	6800
CPA-T101-B70	800	0.0221	0.034	825	863	742	1118	974	967	48.4	8770
CPA-T101-B80	1000	0.0176	0.0298	885	934	820	1233	1086	1084	55.9	10935
1 Core - AL/PVC/ATA/PVC											
APA-T101-B11	16	1.91	2.2949	86	87	66	89	74	72	15.7	335
APA-T101-B12	25	1.2	1.4419	110	112	85	117	97	95	16.8	390
APA-T101-B13	35	0.868	1.043	132	134	102	142	119	116	17.9	445
APA-T101-B14	50	0.641	0.7704	157	159	122	172	143	140	19.2	505
APA-T101-B15	70	0.443	0.5326	192	195	150	216	180	175	20.8	605
APA-T101-B16	95	0.32	0.3849	229	233	181	263	219	213	22.3	710
APA-T101-B17	120	0.253	0.3046	261	265	207	304	254	247	23.7	815
APA-T101-B18	150	0.206	0.2483	292	297	234	346	289	281	25.1	925
APA-T101-B19	185	0.164	0.1981	331	337	267	398	333	325	26.8	1070
APA-T101-B20	240	0.125	0.1517	383	391	312	471	396	385	29.3	1295
APA-T101-B30	300	0.1	0.1221	432	441	357	541	457	446	32.1	1555
APA-T101-B40	400	0.0778	0.0959	491	503	415	624	534	521	36	1970
APA-T101-B50	500	0.0605	0.0759	556	572	478	722	622	609	39.9	2415
APA-T101-B60	630	0.0469	0.0606	627	648	546	831	719	705	43.4	2930
APA-T101-B70	800	0.0367	0.0495	699	726	624	949	826	814	48.8	3680
APA-T101-B80	1000	0.0291	0.0417	766	802	705	1068	939	930	55.9	4540

The above data is approximate and subjected to manufacturing tolerance.

1.8/3 (3.6) KV Single Core AWA Cables

Single Core Cables, With Stranded Copper or Aluminum Conductors, PVC insulation, Aluminum Wire Armoured, and PVC Sheathed.



Description

- Soft annealed copper or Aluminum conductor, insulated with PVC compound rated 70 °C, Aluminum Wire Armoured and sheathed with PVC compound layer.
- Cables are produced according to IEC 60502 or BS 6346.

Application

- For outdoor and indoor installation in damp and wet locations where mechanical damages are expected to occur.

Product Code	Nominal Cross sectional area	Maximum Conductor Resistance		Current Rating						Approx. Overall Diameter	Approx. Weight
		DC at 20 °C	AC at 70 °C	Laid in ground			Laid in free air (Shaded)				
				Flat	Trefoil	Duct	Flat Separated	Flat Touched	Trefoil Touched		
				⊙⊙⊙	⊙ ⊙ ⊙	⊙ ⊙ ⊙	⊙⊙⊙	⊙⊙⊙	⊙ ⊙ ⊙		
mm ²	Ω/Km	Ω/Km	A	A	A	A	A	A	mm	Kg/Km	
1 Core - Cu/PVC/AWA/PVC											
CPA-T101-X12	25	0.727	0.87	143	145	112	154	130	127	19.1	645
CPA-T101-X13	35	0.524	0.6272	171	174	135	187	158	154	20.2	765
CPA-T101-X14	50	0.387	0.4633	202	206	160	225	190	186	21.5	910
CPA-T101-X15	70	0.268	0.3211	247	251	196	279	237	232	23.1	1145
CPA-T101-X16	95	0.193	0.2316	293	300	235	337	287	281	24.6	1425
CPA-T101-X17	120	0.153	0.184	331	339	268	385	329	323	26	1695
CPA-T101-X18	150	0.124	0.1496	369	379	301	434	373	366	27.4	1980
CPA-T101-X19	185	0.0991	0.1202	413	426	340	491	425	419	29.1	2355
CPA-T101-X20	240	0.0754	0.0924	471	489	395	567	497	492	31.7	2955
CPA-T101-X30	300	0.0601	0.0747	517	542	444	628	561	559	34.8	3630
CPA-T101-X40	400	0.047	0.0598	569	602	499	697	634	637	38.4	4585
CPA-T101-X50	500	0.0366	0.0484	624	667	561	775	714	723	42.4	5740
CPA-T101-X60	630	0.0283	0.0397	674	729	619	848	792	810	46.1	7110
CPA-T101-X70	800	0.0221	0.0333	691	761	658	895	843	874	52	9290
CPA-T101-X80	1000	0.0176	0.0291	723	803	710	971	916	956	59.5	11530
1 Core - AL/PVC/AWA/PVC											
APA-T101-X11	16	1.91	2.2949	86	87	68	91	77	75	18	430
APA-T101-X12	25	1.2	1.4419	111	113	87	120	101	99	19.1	495
APA-T101-X13	35	0.868	1.043	133	135	105	146	123	120	20.2	560
APA-T101-X14	50	0.641	0.7703	158	160	124	176	148	144	21.5	630
APA-T101-X15	70	0.443	0.5325	193	196	153	219	185	180	23.1	740
APA-T101-X16	95	0.32	0.3849	229	234	183	265	224	219	24.6	850
APA-T101-X17	120	0.253	0.3045	260	266	210	305	258	253	26	970
APA-T101-X18	150	0.206	0.2482	290	297	236	344	293	287	27.4	1090
APA-T101-X19	185	0.164	0.198	327	336	268	393	336	330	29.1	1240
APA-T101-X20	240	0.125	0.1515	376	387	313	458	396	389	31.6	1485
APA-T101-X30	300	0.1	0.1219	418	434	355	516	452	446	34.7	1800
APA-T101-X40	400	0.0778	0.0957	469	490	406	584	520	516	38.4	2225
APA-T101-X50	500	0.0605	0.0757	523	551	464	660	596	596	42.3	2680
APA-T101-X60	630	0.0469	0.0603	578	615	523	739	676	681	46	3240
APA-T101-X70	800	0.0367	0.049	613	663	574	805	745	761	52.4	4200
APA-T101-X80	1000	0.0291	0.0411	655	715	633	887	825	848	59.5	5135

The above data is approximate and subjected to manufacturing tolerance.

1.8/3 (3.6) KV Multi Core Unarmoured Cables

Multi Core Cables, with stranded copper or Aluminum conductors, PVC insulated, copper tape shield and PVC Sheath.



Description

- Soft stranded copper or aluminum conductor, insulated with PVC compound rated 70 °C assembled together, Shielded with copper tape and sheathed with PVC compound layer.
- Cable are produced according to IEC 60502.

Application

- For outdoor and indoor installation in damp and wet locations. They are normally used for power distribution in urban networks, industrial plants, as well as in the thermopower and hydropower stations.

Product Code	Nominal Cross sectional area mm ²	Maximum Conductor Resistance		Current Rating			Approx. Overall Diameter mm	Approx. Overall Diameter Kg/Km
		DC at 20 °C Ω/Km	AC at 70 °C Ω/Km	Laid in ground A	Laid in duct A	Laid in free air (Shaded) A		
3 core cables - Cu/PVC/PVC								
CPA-T103-Z12	25 RM	0.727	0.8701	125	95	103	27.7	1325
CPA-T103-Z13	35 RM	0.524	0.6273	151	115	126	30.3	1670
CPA-T103-Z14	50 SM	0.387	0.4634	182	137	152	30.2	2035
CPA-T103-Z15	70 SM	0.268	0.3213	224	169	191	33.3	2740
CPA-T103-Z16	95 SM	0.193	0.2318	268	203	231	35.6	3555
CPA-T103-Z17	120 SM	0.153	0.1843	305	233	267	39	4340
CPA-T103-Z18	150 SM	0.124	0.1499	344	264	306	42.1	5190
CPA-T103-Z19	185 SM	0.0991	0.1205	389	301	351	45.5	6350
CPA-T103-Z20	240 SM	0.0754	0.0928	452	354	416	50.2	8130
CPA-T103-Z30	300 SM	0.0601	0.0752	509	402	477	55.5	10100
CPA-T103-Z40	400 SM	0.047	0.0603	579	463	555	62.9	12910
CPA-T103-Z50	500 SM	0.0366	0.0489	652	527	635	69.8	16390
3 core cables - AL/PVC/PVC								
APA-T103-Z11	16 RM	1.91	2.2949	75	57	61	25.4	725
APA-T103-Z12	25 RM	1.2	1.4419	97	74	80	27.7	880
APA-T103-Z13	35 RM	0.868	1.0431	117	90	98	30.3	1055
APA-T103-Z14	50 SM	0.641	0.7704	141	107	118	30.2	1195
APA-T103-Z15	70 SM	0.443	0.5326	174	131	148	33.3	1495
APA-T103-Z16	95 SM	0.32	0.385	208	157	179	35.6	1805
APA-T103-Z17	120 SM	0.253	0.3047	237	181	208	39	2150
APA-T103-Z18	150 SM	0.206	0.2484	267	205	238	42.1	2520
APA-T103-Z19	185 SM	0.164	0.1982	303	235	274	45.5	2950
APA-T103-Z20	240 SM	0.125	0.1518	354	277	325	50.2	3680
APA-T103-Z30	300 SM	0.1	0.1222	400	315	374	55.5	4445
APA-T103-Z40	400 SM	0.0778	0.0961	460	367	440	62.9	5770
APA-T103-Z50	500 SM	0.0605	0.076	524	423	510	69.8	7165

The above data is approximate and subjected to manufacturing tolerance.

rm: Round, Stranded
sm: Sector, Stranded

1.8/3 (3.6) KV Multi Core STA Cables

Multi Core Cables, with stranded copper or Aluminum conductors, PVC insulated, Steel tape Armoured and PVC Sheath.

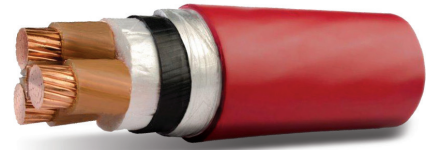

Description

- Soft stranded copper or aluminum conductor, insulated with PVC compound rated 70 °C assembled together, Armoured with Steel tape and sheathed with PVC compound layer.
- Cable are produced according to IEC 60502.

Application

- For outdoor and indoor installation in damp and wet locations Where mechanical damage are expected to occur.

Product Code	Nominal Cross sectional area mm ²	Maximum Conductor Resistance		Current Rating			Approx. Overall Diameter mm	Approx. Overall Diameter Kg/Km
		DC at 20 °C Ω/Km	AC at 70 °C Ω/Km	Laid in ground A	Laid in duct A	Laid in free air (Shaded) A		
3 core cables - Cu/PVC/STA/PVC								
CPA-T103-G12	25 RM	0.727	0.8701	126	96	104	27.9	1425
CPA-T103-G13	35 RM	0.524	0.6273	151	116	126	30.5	1780
CPA-T103-G14	50 SM	0.387	0.4634	182	138	153	30.4	2105
CPA-T103-G15	70 SM	0.268	0.3213	225	171	193	34.7	3115
CPA-T103-G16	95 SM	0.193	0.2318	269	206	234	37	3960
CPA-T103-G17	120 SM	0.153	0.1843	307	236	271	40.4	4790
CPA-T103-G18	150 SM	0.124	0.1499	346	267	309	43.5	5675
CPA-T103-G19	185 SM	0.0991	0.1205	391	304	355	46.7	6835
CPA-T103-G20	240 SM	0.0754	0.0928	454	354	419	51.4	8660
CPA-T103-G30	300 SM	0.0601	0.0752	511	402	481	56.5	10665
CPA-T103-G40	400 SM	0.047	0.0603	580	465	558	63.9	13545
CPA-T103-G50	500 SM	0.0366	0.0489	652	528	638	70.6	17060
3 core cables - AL/PVC/STA/PVC								
APA-T103-G11	16 RM	1.91	2.2949	75	57	61	25.6	805
APA-T103-G12	25 RM	1.2	1.4419	98	74	80	27.9	980
APA-T103-G13	35 RM	0.868	1.0431	117	90	98	30.5	1170
APA-T103-G14	50 SM	0.641	0.7704	141	107	118	30.4	1265
APA-T103-G15	70 SM	0.443	0.5326	175	133	150	34.7	1870
APA-T103-G16	95 SM	0.32	0.385	209	160	182	37	2210
APA-T103-G17	120 SM	0.253	0.3047	239	184	211	40.4	2600
APA-T103-G18	150 SM	0.206	0.2484	269	208	240	43.5	3005
APA-T103-G19	185 SM	0.164	0.1982	305	237	277	46.7	3435
APA-T103-G20	240 SM	0.125	0.1518	355	278	329	51.4	4210
APA-T103-G30	300 SM	0.1	0.1222	402	316	378	56.5	5010
APA-T103-G40	400 SM	0.0778	0.0961	461	370	444	63.9	6405
APA-T103-G50	500 SM	0.0605	0.076	525	425	514	70.6	7835

The above data is approximate and subjected to manufacturing tolerance.

rm: Round, Stranded
sm: Sector, Stranded

1.8/3 (3.6) KV Multi Core SWA Cables

Multi Core Cables, with stranded copper or Aluminum conductors, PVC insulated, Steel wire Armoured and PVC Sheath.



Description

- Soft stranded copper or aluminum conductor, insulated with PVC compound rated 70 °C assembled together, Armoured with Steel wire and sheathed with PVC compound layer.
- Cable are produced according to IEC 60502, BS 6346.

Application

- for outdoor and indoor installation in damp and wet locations Where mechanical damage are expected to occur.

Product Code	Nominal Cross sectional area mm ²	Maximum Conductor Resistance		Current Rating			Approx. Overall Diameter mm	Approx. Overall Diameter Kg/Km
		DC at 20 °C Ω/Km	AC at 70 °C Ω/Km	Laid in ground A	Laid in duct A	Laid in free air (Shaded) A		
3 core cables - Cu/PVC/SWA/PVC								
CPA-T103-W12	25 RM	0.727	0.8701	126	97	106	31.4	2075
CPA-T103-W13	35 RM	0.524	0.6273	152	118	129	34	2485
CPA-T103-W14	50 SM	0.387	0.4634	184	141	158	34.3	2990
CPA-T103-W15	70 SM	0.268	0.3213	227	174	197	37.4	3775
CPA-T103-W16	95 SM	0.193	0.2318	271	207	238	39.5	4645
CPA-T103-W17	120 SM	0.153	0.1843	308	239	276	44.1	5960
CPA-T103-W18	150 SM	0.124	0.1499	347	270	315	47.2	6920
CPA-T103-W19	185 SM	0.0991	0.1205	391	307	360	50.4	8160
CPA-T103-W20	240 SM	0.0754	0.0928	452	355	423	55.1	10115
CPA-T103-W30	300 SM	0.0601	0.0752	505	402	481	60.4	12315
CPA-T103-W40	400 SM	0.047	0.0603	566	456	554	68.9	16155
CPA-T103-W50	500 SM	0.0366	0.0489	628	511	625	75.8	19925
3 core cables - AL/PVC/SWA/PVC								
APA-T103-W11	16 RM	1.91	2.2949	76	58	63	28.9	1385
APA-T103-W12	25 RM	1.2	1.4419	98	76	82	31.4	1625
APA-T103-W13	35 RM	0.868	1.0431	118	91	100	34	1875
APA-T103-W14	50 SM	0.641	0.7704	143	109	122	34.3	2145
APA-T103-W15	70 SM	0.443	0.5326	176	135	153	37.4	2530
APA-T103-W16	95 SM	0.32	0.385	211	161	185	39.5	2895
APA-T103-W17	120 SM	0.253	0.3047	240	187	215	44.1	3770
APA-T103-W18	150 SM	0.206	0.2484	270	211	245	47.2	4250
APA-T103-W19	185 SM	0.164	0.1982	306	240	282	50.4	4760
APA-T103-W20	240 SM	0.125	0.1518	356	280	333	55.1	5665
APA-T103-W30	300 SM	0.1	0.1222	400	319	381	60.4	6660
APA-T103-W40	400 SM	0.0778	0.0961	456	367	445	68.9	9015
APA-T103-W50	500 SM	0.0605	0.076	514	418	510	75.8	10705

The above data is approximate and subjected to manufacturing tolerance.

rm: Round, Stranded
sm: Sector, Stranded

1.8/3 (3.6) KV Single core Unarmoured Cables

Single Core Cables, with stranded Circular copper or Aluminum conductors, XLPE insulated, copper tape shield and PVC Sheath.



Description

- Soft stranded copper or aluminum conductor, insulated with XLPE compound rated 90 °C Shielded with copper tape and sheathed with PVC compound layer.
- Cable are produced according to IEC 60502.

Application

- For outdoor and indoor installation in damp and wet locations. They are normally used for power distribution in urban networks, industrial plants, as well as in the thermopower and hydropower stations.

Product Code	Nominal Cross sectional area	Maximum Conductor Resistance		Current Rating						Approx. Overall Diameter	Approx. Weight
		DC at 20 °C	AC at 90 °C	Laid in ground			Laid in free air (Shaded)				
				Flat	Trefoil	Duct	Flat Separated	Flat Touched	Trefoil Touched		
mm ²	Ω/Km	Ω/Km	A	A	A	A	A	A	mm	Kg/Km	
1 Core - Cu/XLPE/PVC											
CXA-T101-U12	25	0.727	0.9272	166	168	123	185	148	144	12.6	365
CXA-T101-U13	35	0.524	0.6684	199	202	148	227	182	177	13.7	460
CXA-T101-U14	50	0.387	0.4939	236	239	177	275	221	215	15	585
CXA-T101-U15	70	0.268	0.3423	289	293	219	346	279	271	16.8	795
CXA-T101-U16	95	0.193	0.247	345	350	264	423	342	332	18.3	1050
CXA-T101-U17	120	0.153	0.1963	391	397	304	490	397	386	19.9	1300
CXA-T101-U18	150	0.124	0.1596	439	446	344	560	455	441	21.3	1565
CXA-T101-U19	185	0.0991	0.1283	495	504	392	646	526	510	23.2	1920
CXA-T101-U20	240	0.0754	0.0988	573	583	462	769	627	609	25.8	2475
CXA-T101-U30	300	0.0601	0.0801	645	657	528	889	725	704	28.2	3040
CXA-T101-U40	400	0.047	0.0645	728	743	602	1032	841	816	31	3865
CXA-T101-U50	500	0.0366	0.0523	820	838	693	1199	978	950	35.2	4960
CXA-T101-U60	630	0.0283	0.043	915	937	790	1383	1124	1093	39.3	6280
CXA-T101-U70	800	0.0221	0.0365	1008	1034	887	1580	1277	1243	44.2	8175
CXA-T101-U80	1000	0.0176	0.0319	1097	1130	994	1796	1448	1412	51.7	10225
1 Core - AL/XLPE/PVC											
AXA-T101-U11	16	1.91	2.4489	100	102	74	109	87	85	11.5	170
AXA-T101-U12	25	1.2	1.5386	129	131	96	144	115	112	12.6	215
AXA-T101-U13	35	0.868	1.113	155	157	115	176	141	137	13.7	255
AXA-T101-U14	50	0.641	0.8221	183	185	137	213	171	166	15	305
AXA-T101-U15	70	0.443	0.5683	224	227	170	269	216	210	16.8	390
AXA-T101-U16	95	0.32	0.4108	267	271	205	328	265	257	18.3	480
AXA-T101-U17	120	0.253	0.3251	304	309	236	381	309	300	19.9	575
AXA-T101-U18	150	0.206	0.265	341	346	267	435	353	343	21.3	675
AXA-T101-U19	185	0.164	0.2115	386	393	306	503	410	398	23.2	805
AXA-T101-U20	240	0.125	0.1619	448	456	361	599	490	475	25.7	1005
AXA-T101-U30	300	0.1	0.1304	507	516	414	695	569	551	28.1	1210
AXA-T101-U40	400	0.0778	0.1026	579	590	478	815	668	648	31	1505
AXA-T101-U50	500	0.0605	0.0812	660	673	557	955	787	763	35.1	1900
AXA-T101-U60	630	0.0469	0.0648	749	765	645	1114	919	892	39.2	2410
AXA-T101-U70	800	0.0367	0.0529	842	863	740	1298	1070	1039	44.6	3080
AXA-T101-U80	1000	0.0291	0.0445	936	961	845	1500	1234	1200	51.7	3830

The above data is approximate and subjected to manufacturing tolerance.

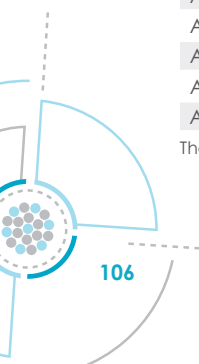

1.8/3 (3.6) KV Single Core ATA Cables

Single Core Cables, With Stranded Copper or Aluminum Conductors, XLPE insulation, Aluminum Tape Armoured, and PVC Sheathed.



Description

- Soft annealed copper or Aluminum conductor, insulated with XLPE compound rated 90 °C, Aluminum Tape Armoured and sheathed with PVC compound layer.
- Cables are produced according to IEC 60502.

Application

- For outdoor and indoor installation in damp and wet locations where mechanical damages are expected to occur.

Product Code	Nominal Cross sectional area	Maximum Conductor Resistance		Current Rating						Approx. Overall Diameter	Approx. Weight
		DC at 20 °C	AC at 90 °C	Laid in ground			Laid in free air (Shaded)				
				Flat	Trefoil	Duct	Flat Separated	Flat Touched	Trefoil Touched		
mm ²	Ω/Km	Ω/Km	A	A	A	A	A	A	mm	Kg/Km	
1 Core - Cu/XLPE/ATA/PVC											
CXA-T101-B12	25	0.727	0.9271	167	169	129	192	159	154	16.4	485
CXA-T101-B13	35	0.524	0.6684	200	203	155	234	193	188	17.5	590
CXA-T101-B14	50	0.387	0.4938	237	240	185	282	233	227	18.8	730
CXA-T101-B15	70	0.268	0.3422	289	294	228	353	292	284	20.4	945
CXA-T101-B16	95	0.193	0.2468	345	351	275	429	356	346	21.9	1210
CXA-T101-B17	120	0.153	0.1961	391	398	314	495	411	400	23.3	1460
CXA-T101-B18	150	0.124	0.1594	438	446	353	562	468	456	24.7	1735
CXA-T101-B19	185	0.0991	0.128	494	504	404	645	539	525	26.4	2090
CXA-T101-B20	240	0.0754	0.0984	570	582	471	760	638	622	29	2660
CXA-T101-B30	300	0.0601	0.0797	640	655	536	871	734	716	31.4	3240
CXA-T101-B40	400	0.047	0.0638	719	739	613	997	846	828	34.6	4120
CXA-T101-B50	500	0.0366	0.0516	805	831	698	1141	975	957	38.6	5230
CXA-T101-B60	630	0.0283	0.0423	892	926	792	1291	1110	1094	42.7	6575
CXA-T101-B70	800	0.0221	0.0356	974	1018	884	1439	1248	1236	48	8545
CXA-T101-B80	1000	0.0176	0.031	1049	1105	981	1592	1396	1390	55.5	10660
1 Core - AL/XLPE/ATA/PVC											
AXA-T101-B11	16	1.91	2.4489	101	102	77	113	94	92	15.3	290
AXA-T101-B12	25	1.2	1.5386	130	131	100	149	123	120	16.4	335
AXA-T101-B13	35	0.868	1.113	155	157	120	181	150	146	17.5	390
AXA-T101-B14	50	0.641	0.822	184	186	144	219	181	176	18.8	450
AXA-T101-B15	70	0.443	0.5683	225	228	177	274	227	221	20.4	540
AXA-T101-B16	95	0.32	0.4107	268	272	213	334	276	269	21.9	635
AXA-T101-B17	120	0.253	0.325	305	310	245	386	320	311	23.3	735
AXA-T101-B18	150	0.206	0.2649	341	347	274	439	364	355	24.7	840
AXA-T101-B19	185	0.164	0.2113	386	393	315	506	421	410	26.4	975
AXA-T101-B20	240	0.125	0.1617	447	456	368	598	500	487	28.9	1190
AXA-T101-B30	300	0.1	0.1301	504	515	422	688	577	562	31.3	1410
AXA-T101-B40	400	0.0778	0.1022	574	588	488	798	675	658	34.6	1760
AXA-T101-B50	500	0.0605	0.0808	652	670	563	925	788	770	38.5	2165
AXA-T101-B60	630	0.0469	0.0643	735	759	648	1064	913	895	42.6	2705
AXA-T101-B70	800	0.0367	0.0523	821	852	743	1214	1052	1035	48.4	3460
AXA-T101-B80	1000	0.0291	0.0438	903	944	838	1371	1200	1186	55.5	4265

The above data is approximate and subjected to manufacturing tolerance.

1.8/3 (3.6) KV Single Core AWA Cables

Single Core Cables, With Stranded Copper or Aluminum Conductors, XLPE insulation, Aluminum Wire Armoured, and PVC Sheathed.



Description

- Soft annealed copper or Aluminum conductor, insulated with XLPE compound rated 90 °C, Aluminum Wire Armoured and sheathed with PVC compound layer.
- Cables are produced according to IEC 60502 or BS 5467.

Application

- For outdoor and indoor installation in damp and wet locations where mechanical damages are expected to occur.

Product Code	Nominal Cross sectional area	Maximum Conductor Resistance		Current Rating						Approx. Overall Diameter	Approx. Weight
		DC at 20 °C	AC at 90 °C	Laid in ground			Laid in free air (Shaded)				
				Flat	Trefoil	Duct	Flat Separated	Flat Touched	Trefoil Touched		
mm ²	Ω/Km	Ω/Km	A	A	A	A	A	A	mm	Kg/Km	
1 Core - Cu/XLPE/AWA/PVC											
CXA-T101-X12	25	0.727	0.9271	169	171	133	197	165	161	18.7	590
CXA-T101-X13	35	0.524	0.6683	202	205	159	239	201	196	19.8	705
CXA-T101-X14	50	0.387	0.4937	238	242	189	287	241	235	21.1	845
CXA-T101-X15	70	0.268	0.3422	289	295	232	356	300	293	22.7	1075
CXA-T101-X16	95	0.193	0.2467	344	351	278	430	363	355	24.2	1350
CXA-T101-X17	120	0.153	0.196	388	397	317	491	417	409	25.6	1610
CXA-T101-X18	150	0.124	0.1593	433	444	357	554	473	464	27	1890
CXA-T101-X19	185	0.0991	0.1279	484	499	404	627	539	530	28.7	2260
CXA-T101-X20	240	0.0754	0.0982	553	573	469	725	631	624	31.3	2845
CXA-T101-X30	300	0.0601	0.0794	613	639	528	813	717	711	33.9	3460
CXA-T101-X40	400	0.047	0.0635	673	710	593	898	809	810	37.2	4375
CXA-T101-X50	500	0.0366	0.0512	738	787	668	997	913	923	41.2	5510
CXA-T101-X60	630	0.0283	0.0418	801	864	745	1097	1019	1038	45.1	6860
CXA-T101-X70	800	0.0221	0.0349	825	905	797	1152	1088	1126	51.6	9055
CXA-T101-X80	1000	0.0176	0.0304	864	958	862	1248	1184	1235	59.1	11245
1 Core - AL/XLPE/AWA/PVC											
AXA-T101-X11	16	1.91	2.4489	102	103	80	117	98	96	17.6	390
AXA-T101-X12	25	1.2	1.5386	131	133	103	153	128	125	18.7	440
AXA-T101-X13	35	0.868	1.113	157	159	123	186	156	152	19.8	500
AXA-T101-X14	50	0.641	0.822	185	188	147	224	187	183	21.1	565
AXA-T101-X15	70	0.443	0.5682	226	230	181	279	234	228	22.7	670
AXA-T101-X16	95	0.32	0.4107	268	273	217	337	283	277	24.2	780
AXA-T101-X17	120	0.253	0.3249	304	311	248	388	327	319	25.6	885
AXA-T101-X18	150	0.206	0.2648	339	347	279	438	371	362	27	1000
AXA-T101-X19	185	0.164	0.2112	383	392	317	500	426	417	28.7	1145
AXA-T101-X20	240	0.125	0.1615	440	452	371	584	501	492	31.2	1375
AXA-T101-X30	300	0.1	0.1299	492	508	420	661	574	565	33.8	1630
AXA-T101-X40	400	0.0778	0.102	551	574	480	749	661	655	37.2	2015
AXA-T101-X50	500	0.0605	0.0805	616	647	550	847	759	757	41.1	2445
AXA-T101-X60	630	0.0469	0.064	683	724	625	951	865	868	45	2990
AXA-T101-X70	800	0.0367	0.0518	725	782	688	1031	955	972	52	3980
AXA-T101-X80	1000	0.0291	0.0432	778	848	763	1136	1061	1089	59.1	4850

The above data is approximate and subjected to manufacturing tolerance.

1.8/3 (3.6) KV Multi Core Unarmoured Cables

Multi Core Cables, with stranded copper or Aluminum conductors, XLPE insulated, copper tape shield and PVC Sheath.



Description

- Soft stranded copper or aluminum conductor, insulated with XLPE compound rated 90 °C assembled together, Shielded with copper tape and sheathed with PVC compound layer.
- Cable are produced according to IEC 60502.

Application

- For outdoor and indoor installation in damp and wet locations. They are normally used for power distribution in urban networks, industrial plants, as well as in the thermopower and hydropower stations.

Product Code	Nominal Cross sectional area mm ²	Maximum Conductor Resistance		Current Rating			Approx. Overall Diameter mm	Approx. Overall Diameter Kg/Km
		DC at 20 °C Ω/Km	AC at 90 °C Ω/Km	Laid in ground A	Laid in duct A	Laid in free air (Shaded) A		
3 core cables - Cu/XLPE/PVC								
CXA-T103-Z12	25 RM	0.727	0.9272	149	113	130	26.9	1200
CXA-T103-Z13	35 RM	0.524	0.6685	179	136	159	29.4	1525
CXA-T103-Z14	50 SM	0.387	0.4939	213	160	190	29.4	1875
CXA-T103-Z15	70 SM	0.268	0.3423	262	198	238	32.5	2545
CXA-T103-Z16	95 SM	0.193	0.247	315	240	291	35.8	3355
CXA-T103-Z17	120 SM	0.153	0.1962	356	274	333	38.2	4100
CXA-T103-Z18	150 SM	0.124	0.1596	401	311	380	41.3	4930
CXA-T103-Z19	185 SM	0.0991	0.1282	453	354	437	44.5	6045
CXA-T103-Z20	240 SM	0.0754	0.0987	525	414	516	49.4	7795
CXA-T103-Z30	300 SM	0.0601	0.0799	594	473	592	53.7	9595
CXA-T103-Z40	400 SM	0.047	0.0641	675	545	688	60.3	12220
CXA-T103-Z50	500 SM	0.0366	0.0518	760	622	788	67.2	15615
3 core cables - AL/XLPE/PVC								
AXA-T103-Z11	16 RM	1.91	2.4489	89	67	77	24.5	615
AXA-T103-Z12	25 RM	1.2	1.5387	115	88	101	26.9	750
AXA-T103-Z13	35 RM	0.868	1.1131	138	105	123	29.4	910
AXA-T103-Z14	50 SM	0.641	0.8221	165	124	147	29.4	1030
AXA-T103-Z15	70 SM	0.443	0.5683	203	154	184	32.5	1300
AXA-T103-Z16	95 SM	0.32	0.4108	244	186	226	35.8	1605
AXA-T103-Z17	120 SM	0.253	0.3251	276	213	259	38.2	1910
AXA-T103-Z18	150 SM	0.206	0.265	311	241	295	41.3	2260
AXA-T103-Z19	185 SM	0.164	0.2114	353	276	340	44.5	2640
AXA-T103-Z20	240 SM	0.125	0.1618	411	323	403	49.4	3345
AXA-T103-Z30	300 SM	0.1	0.1302	465	371	464	53.7	3960
AXA-T103-Z40	400 SM	0.0778	0.1023	535	432	545	60.3	5080
AXA-T103-Z50	500 SM	0.0605	0.0809	609	498	632	67.2	6375

The above data is approximate and subjected to manufacturing tolerance.

rm: Round, Stranded
sm: Sector, Stranded

1.8/3 (3.6) KV Multi Core STA Cables

Multi Core Cables, with stranded copper or Aluminum conductors, XLPE insulated, Steel tape Armoured and PVC Sheath.

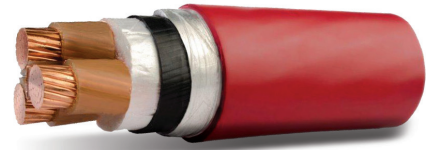

Description

- Soft stranded copper or aluminum conductor, insulated with XLPE compound rated 90 °C assembled together, Armoured with Steel tape and sheathed with PVC compound layer.
- Cable are produced according to IEC 60502.

Application

- For outdoor and indoor installation in damp and wet locations Where mechanical damage are expected to occur.

Product Code	Nominal Cross sectional area mm ²	Maximum Conductor Resistance		Current Rating			Approx. Overall Diameter mm	Approx. Overall Diameter Kg/Km
		DC at 20 °C Ω/Km	AC at 90 °C Ω/Km	Laid in ground A	Laid in duct A	Laid in free air (Shaded) A		
3 core cables - Cu/XLPE/STA/PVC								
CXA-T103-G12	25 RM	0.727	0.9272	149	113	131	27.1	1295
CXA-T103-G13	35 RM	0.524	0.6685	179	136	160	29.6	1635
CXA-T103-G14	50 SM	0.387	0.4939	214	160	190	29.4	1930
CXA-T103-G15	70 SM	0.268	0.3423	262	198	238	32.5	2600
CXA-T103-G16	95 SM	0.193	0.247	317	243	295	37	3755
CXA-T103-G17	120 SM	0.153	0.1962	358	276	337	39.2	4510
CXA-T103-G18	150 SM	0.124	0.1596	403	312	385	42.3	5370
CXA-T103-G19	185 SM	0.0991	0.1282	455	355	441	45.7	6530
CXA-T103-G20	240 SM	0.0754	0.0987	527	417	520	50.4	8305
CXA-T103-G30	300 SM	0.0601	0.0799	595	473	596	54.7	10150
CXA-T103-G40	400 SM	0.047	0.0641	676	545	693	61.1	12810
CXA-T103-G50	500 SM	0.0366	0.0518	760	620	792	67.8	16245
3 core cables - AL/XLPE/STA/PVC								
AXA-T103-G11	16 RM	1.91	2.4489	90	68	77	24.7	690
AXA-T103-G12	25 RM	1.2	1.5387	116	88	102	27.1	845
AXA-T103-G13	35 RM	0.868	1.1131	139	105	124	29.6	1020
AXA-T103-G14	50 SM	0.641	0.8221	166	124	147	29.4	1090
AXA-T103-G15	70 SM	0.443	0.5683	204	154	185	32.5	1355
AXA-T103-G16	95 SM	0.32	0.4108	246	189	229	37	2005
AXA-T103-G17	120 SM	0.253	0.3251	278	214	262	39.2	2320
AXA-T103-G18	150 SM	0.206	0.265	313	243	299	42.3	2700
AXA-T103-G19	185 SM	0.164	0.2114	355	277	344	45.7	3130
AXA-T103-G20	240 SM	0.125	0.1618	412	326	407	50.4	3850
AXA-T103-G30	300 SM	0.1	0.1302	467	372	468	54.7	4515
AXA-T103-G40	400 SM	0.0778	0.1023	537	432	550	61.1	5670
AXA-T103-G50	500 SM	0.0605	0.0809	611	498	636	67.8	7005

The above data is approximate and subjected to manufacturing tolerance.

rm: Round, Stranded
sm: Sector, Stranded

1.8/3 (3.6) KV Multi Core SWA Cables

Multi Core Cables, with stranded copper or Aluminum conductors, XLPE insulated, Steel wire Armoured and PVC Sheath.

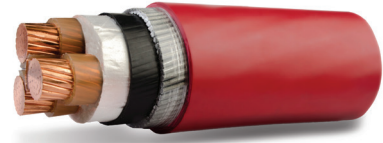

Description

- Soft stranded copper or aluminum conductor, insulated with XLPE compound rated 90 °C assembled together, Armoured with Steel wire and sheathed with PVC compound layer.
- Cable are produced according to IEC 60502, BS 5467.

Application

- For outdoor and indoor installation in damp and wet locations Where mechanical damage are expected to occur.

Product Code	Nominal Cross sectional area mm ²	Maximum Conductor Resistance		Current Rating			Approx. Overall Diameter mm	Approx. Overall Diameter Kg/Km
		DC at 20 °C Ω/Km	AC at 90 °C Ω/Km	Laid in ground A	Laid in duct A	Laid in free air (Shaded) A		
3 core cables - Cu/XLPE/SWA/PVC								
CXA-T103-W12	25 RM	0.727	0.9272	150	116	134	30.6	1930
CXA-T103-W13	35 RM	0.524	0.6685	180	139	163	32.9	2310
CXA-T103-W14	50 SM	0.387	0.4939	216	165	197	33.3	2770
CXA-T103-W15	70 SM	0.268	0.3423	265	203	246	36.4	3555
CXA-T103-W16	95 SM	0.193	0.247	319	245	300	39.5	4440
CXA-T103-W17	120 SM	0.153	0.1962	360	280	344	42.9	5655
CXA-T103-W18	150 SM	0.124	0.1596	405	316	392	46	6590
CXA-T103-W19	185 SM	0.0991	0.1282	456	359	448	49.4	7830
CXA-T103-W20	240 SM	0.0754	0.0987	526	419	526	53.9	9710
CXA-T103-W30	300 SM	0.0601	0.0799	590	473	599	58.4	11720
CXA-T103-W40	400 SM	0.047	0.0641	665	539	689	64.8	14570
CXA-T103-W50	500 SM	0.0366	0.0518	736	603	779	73	19020
3 core cables - AL/XLPE/SWA/PVC								
AXA-T103-W11	16 RM	1.91	2.4489	90	69	80	28	1245
AXA-T103-W12	25 RM	1.2	1.5387	117	90	104	30.6	1485
AXA-T103-W13	35 RM	0.868	1.1131	140	108	127	32.9	1695
AXA-T103-W14	50 SM	0.641	0.8221	168	128	153	33.3	1925
AXA-T103-W15	70 SM	0.443	0.5683	206	158	191	36.4	2310
AXA-T103-W16	95 SM	0.32	0.4108	247	191	233	39.5	2690
AXA-T103-W17	120 SM	0.253	0.3251	281	218	268	42.9	3465
AXA-T103-W18	150 SM	0.206	0.265	315	246	305	46	3920
AXA-T103-W19	185 SM	0.164	0.2114	356	281	350	49.4	4430
AXA-T103-W20	240 SM	0.125	0.1618	414	330	413	53.9	5255
AXA-T103-W30	300 SM	0.1	0.1302	466	374	473	58.4	6085
AXA-T103-W40	400 SM	0.0778	0.1023	532	431	551	64.8	7430
AXA-T103-W50	500 SM	0.0605	0.0809	600	491	633	73	9780

The above data is approximate and subjected to manufacturing tolerance.

rm: Round, Stranded
sm: Sector, Stranded



السعودي
للكابلات
ELSEWEDY
CABLES

ELSEWEDY CABLES
ZG15321
514022001

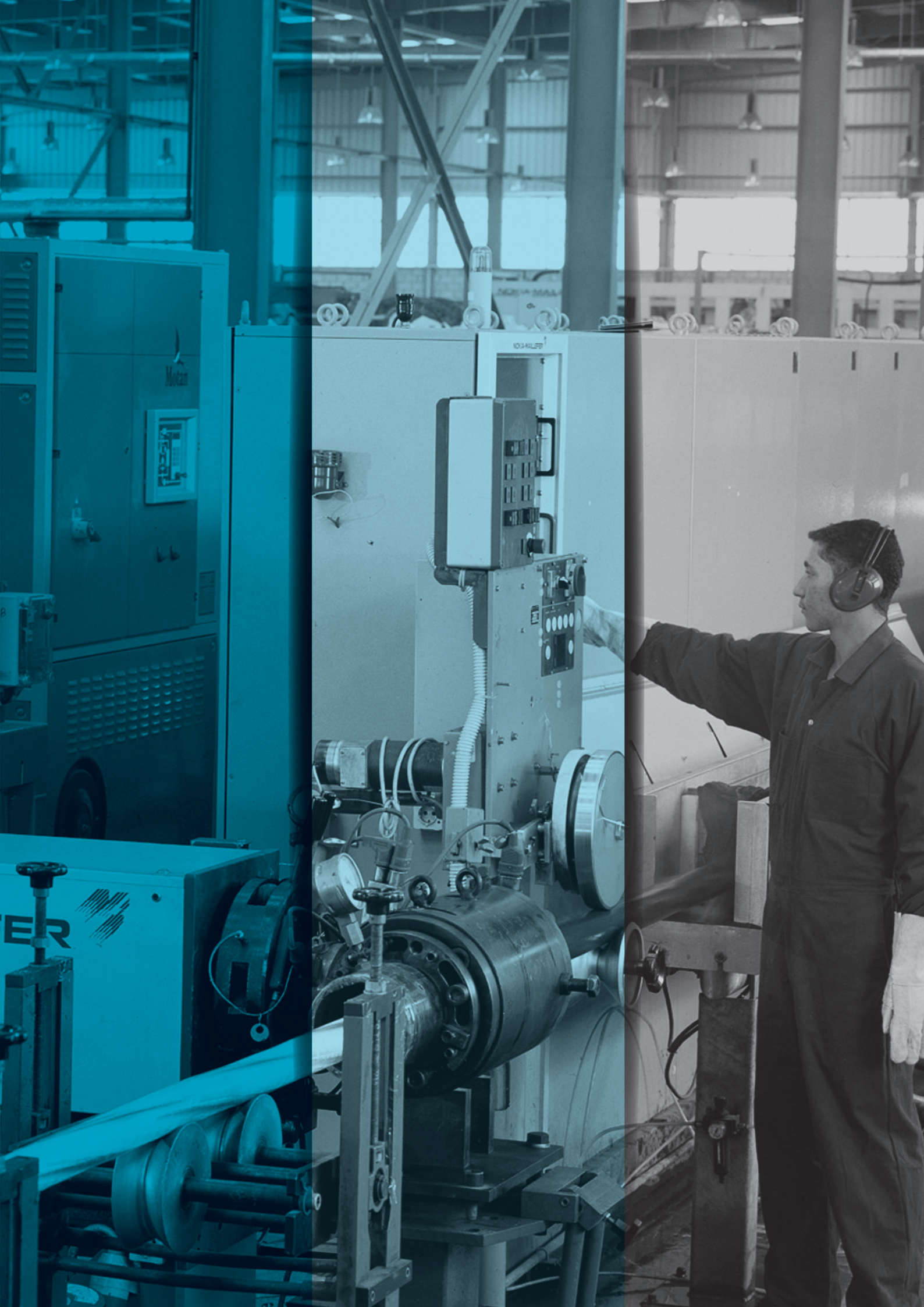

Medium Voltage Cables

**Operating Voltage
(up to 18/30 kV)**

Cable Construction

1. Conductor

Stranded, round and compacted Copper or Aluminium conductors, according to IEC 60228 - class 2.

2. Conductor Screen

An extruded layer of semi conducting material applied over the conductor as voltage stress control layer.

3. Insulation

An extruded layer of cross linked polyethylene (XLPE) is applied over the inner semi conductor with thickness as specified in IEC 60502.

4. Insulation Screen

An extruded layer of strippable or firmly bonded to the insulation. Conductor screen, XLPE insulation and insulation screen are applied at the same time using triple head extruder.

5. Metallic Screen

- Copper Tape: an annealed Copper tape is applied helically with a suitable overlap.
- Copper Wire: helically applied and binded with a Copper tape to achieve electrical contact

6. Assembly

In case of three core cables, cores are assembled together with suitable lay length, non-hygroscopic filler is applied during assembly to fill spaces between cores then wrapped with suitable binder tape.

7. Bedding

In case of armoured cables an extruded layer of PVC or PE is applied as bedding.

8. Armouring

- Steel Tape: double layers of steel tapes are applied helically.
- Steel Wire: galvanized steel wires are applied helically.

9. Sheath

An extruded layer of PVC is applied with thickness as specified in IEC 60502.

Option

Lead Sheath: Upon request a layer of lead is extruded over the bedding layer.

Armouring of Single Core Cable

- Armouring by non-magnetic material either Aluminium Tape or Aluminium Wire armouring to reduce the magnetic losses.
- If it is required for single core cable to be armoured by steel wire armouring, the magnetic circuit around the single core cable should be interrupted by inserting insulated copper wires between the steel wires.

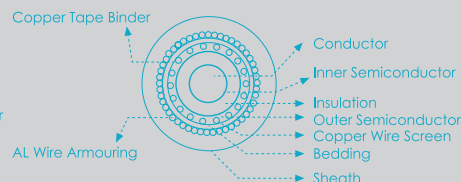
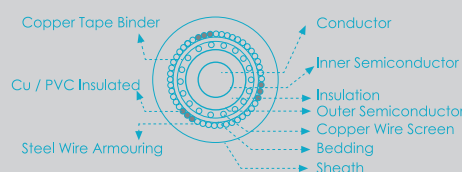

3.6/6 (7.2) KV Single core Unarmoured Cables

Single Core Cables, with stranded Circular copper or Aluminum conductors, XLPE insulated, and PVC Sheath.



Description

- Stranded circular compacted copper or aluminum conductor, Semi-conducting layer as conductor screen, XLPE insulated, semi-conducting layer as non metallic insulation screen, copper tape or wire as metallic insulation screen, and PVC sheathed.
- Cables are produced according to IEC 60502.

Application

- These cables are generally suitable for direct burial or for installation on trays or in ducts.

Product Code	Nominal Cross sectional area	Max. Conductor Resistance		Capacitance	Inductance		Current Rating					Approx. Overall Diameter	Approx. Weight
		DC at 20 °C	AC at 90 °C		Trefoil	Flat	Laid in ground			Laid in free air (Shaded)			
							Flat	Trefoil	Duct	Flat Touched	Trefoil Touched		
		mm ²	Ω/Km		Ω/Km	µf/km	mh/km	A	A	A	A		
1 Core - Cu/XLPE/PVC													
CXB-T101-U12	25	0.727	0.9271	0.2520	0.4033	0.5733	168	172	124	151	155	15.8	450
CXB-T101-U13	35	0.524	0.6684	0.2832	0.3820	0.5538	201	207	149	184	189	16.9	555
CXB-T101-U14	50	0.387	0.4938	0.3200	0.3557	0.5362	238	245	179	223	229	18.4	700
CXB-T101-U15	70	0.268	0.3422	0.3735	0.3336	0.5126	292	292	228	282	290	20.3	925
CXB-T101-U16	95	0.193	0.2468	0.4072	0.3245	0.4901	348	347	270	343	350	21.7	1185
CXB-T101-U17	120	0.153	0.1961	0.4464	0.3137	0.4668	395	394	310	395	405	23.1	1435
CXB-T101-U18	150	0.124	0.1594	0.4856	0.3062	0.4714	443	441	351	451	462	24.7	1715
CXB-T101-U19	185	0.0991	0.1280	0.5331	0.2941	0.4769	501	498	400	520	532	26.4	2085
CXB-T101-U20	240	0.0754	0.0984	0.6001	0.2846	0.4666	580	575	468	618	630	29	2660
CXB-T101-U30	300	0.0601	0.0796	0.6492	0.2781	0.4616	654	646	546	714	726	32	3265
CXB-T101-U40	400	0.047	0.0637	0.6722	0.2734	0.4571	742	727	619	827	838	35.2	4125
CXB-T101-U50	500	0.0366	0.0515	0.7107	0.2676	0.4513	837	815	709	960	965	39.2	5280
CXB-T101-U60	630	0.0283	0.0422	0.7908	0.2612	0.4452	934	904	804	1099	1098	42.9	6620
CXB-T101-U70	800	0.0221	0.0356	0.8917	0.2558	0.4401	1032	988	902	1246	1232	47.8	8505
1 Core - AL/XLPE/PVC													
AXB-T101-U12	25	1.2	1.5386	0.2520	0.4033	0.4495	130	133	97	118	121	15.8	300
AXB-T101-U13	35	0.868	1.1130	0.2832	0.3820	0.4282	156	160	118	144	152	16.9	350
AXB-T101-U14	50	0.641	0.8220	0.3200	0.3557	0.4019	185	190	142	174	182	18.4	415
AXB-T101-U15	70	0.443	0.5683	0.3651	0.3367	0.3829	222	230	175	223	229	20	505
AXB-T101-U16	95	0.32	0.4107	0.4072	0.3245	0.3708	269	278	210	270	274	21.7	610
AXB-T101-U17	120	0.253	0.3250	0.4464	0.3137	0.3599	309	317	243	310	320	23.1	705
AXB-T101-U18	150	0.206	0.2649	0.4856	0.3062	0.3524	340	348	274	352	360	24.7	825
AXB-T101-U19	185	0.164	0.2113	0.5331	0.2941	0.3403	390	393	312	410	420	26.4	955
AXB-T101-U20	240	0.125	0.1617	0.5973	0.2850	0.3312	452	454	375	484	495	28.9	1170
AXB-T101-U30	300	0.1	0.1300	0.6412	0.2786	0.3248	513	509	423	560	571	31.7	1415
AXB-T101-U40	400	0.0778	0.1021	0.6672	0.2723	0.3185	587	577	490	655	665	35	1750
AXB-T101-U50	500	0.0605	0.0807	0.7084	0.2688	0.3151	671	660	570	769	779	39.3	2190
AXB-T101-U60	630	0.0469	0.0642	0.7896	0.2620	0.3083	762	770	655	895	900	43	2700
AXB-T101-U70	800	0.0367	0.0523	0.9010	0.2552	0.3014	858	885	749	1032	1032	48.2	3400

The above data is approximate and subjected to manufacturing tolerance this data is applicable also for 3.8/6.6 KV

3.6/6 (7.2) KV Multi Core Unarmoured Cables

Three Core Cables, with stranded circular copper or Aluminum conductors, XLPE insulated, and PVC Sheath.



Description

- Stranded circular compacted copper or aluminum conductor, Semi-conducting layer as conductor screen, XLPE insulated, semi-conducting layer as non metallic insulation screen, copper tape or wire as metallic insulation screen, cores are assembled together with non hygroscopic polypropylene fillers and wrapped with binder tape, and PVC sheathed.
- Cables are produced according to IEC 60502.

Application

- These cables are generally suitable for direct burial or for installation on trays or in ducts.

Product Code	Nominal Cross sectional area	Max. Conductor Resistance		Capacitance	Inductance	Current Rating			Approx. Overall Diameter	Approx. Weight
		DC at 20 °C	AC at 90 °C			Ground	Duct	Laid in free air (Shaded)		
		Ω/Km	Ω/Km							
mm ²	Ω/Km	Ω/Km	μf/km	mh/km	A	A	A	mm	Kg/Km	
3 Core - Cu/XLPE/PVC										
CXB-T103-U12	25	0.727	0.9272	0.2520	0.3746	167	123	151	32.8	1475
CXB-T103-U13	35	0.524	0.6684	0.2832	0.3555	197	146	179	35.2	1805
CXB-T103-U14	50	0.387	0.4938	0.3200	0.3291	233	175	217	38.2	2265
CXB-T103-U15	70	0.268	0.3423	0.3735	0.3100	286	216	271	42.7	3020
CXB-T103-U16	95	0.193	0.2470	0.4072	0.3007	342	260	331	45.5	3825
CXB-T103-U17	120	0.153	0.1963	0.4464	0.2916	390	296	383	48.7	4630
CXB-T103-U18	150	0.124	0.1596	0.4856	0.2840	438	337	437	51.9	5500
CXB-T103-U19	185	0.0991	0.1283	0.5331	0.2736	495	384	503	55.8	6685
CXB-T103-U20	240	0.0754	0.0989	0.6001	0.2649	574	450	596	61.4	8515
CXB-T103-U30	300	0.0601	0.0801	0.6492	0.2593	655	519	703	67.8	10445
CXB-T103-U40	400	0.047	0.0644	0.6722	0.2556	731	587	792	74.7	13175
CXB-T103-U50	500	0.0366	0.0523	0.7107	0.2510	824	670	914	83.5	16885
3 Core - AL/XLPE/PVC										
AXB-T103-U12	25	1.2	1.5386	0.2520	0.3746	129	96	118	32.8	1025
AXB-T103-U13	35	0.868	1.1130	0.2832	0.3555	155	115	143	35.2	1190
AXB-T103-U14	50	0.641	0.8220	0.3200	0.3291	184	137	173	38.2	1410
AXB-T103-U15	70	0.443	0.5683	0.3651	0.3127	225	170	217	42.1	1745
AXB-T103-U16	95	0.32	0.4108	0.4072	0.3007	269	204	264	45.5	2095
AXB-T103-U17	120	0.253	0.3251	0.4464	0.2916	307	235	306	48.7	2440
AXB-T103-U18	150	0.206	0.2650	0.4856	0.2840	344	265	348	51.9	2820
AXB-T103-U19	185	0.164	0.2115	0.5331	0.2736	391	303	402	55.8	3295
AXB-T103-U20	240	0.125	0.1619	0.5973	0.2652	449	352	466	61.2	4035
AXB-T103-U30	300	0.1	0.1304	0.6412	0.2596	508	403	539	67.2	4880
AXB-T103-U40	400	0.0778	0.1026	0.6672	0.2543	582	467	631	74.3	6045
AXB-T103-U50	500	0.0605	0.0812	0.7084	0.2523	673	547	753	83.7	7610

The above data is approximate and subjected to manufacturing tolerance
this data is applicable also for 3.8/6.6 KV

3.6/6 (7.2) KV Single Core ATA Cables

Single Core Cables, with stranded Circular copper or Aluminum conductors, XLPE insulated, Aluminum tape armored, and PVC sheath

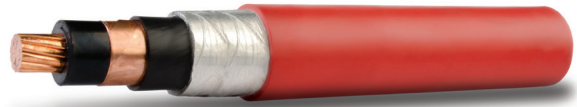

Description

- Stranded circular compacted copper or aluminum conductor, Semi-conducting layer as conductor screen, XLPE insulated, semi-conducting layer as non metallic insulation screen, copper tape or wire as metallic insulation screen, covered with a layer of PVC compound as bedding layer, aluminum tape armored and PVC sheath.
- Cables are produced according to IEC 60502.

Application

- These cables are generally suitable for direct burial or for installation on trays or in ducts.

Product Code	Nominal Cross sectional area	Max. Conductor Resistance		Capacitance	Inductance		Current Rating					Approx. Overall Diameter	Approx. Weight
		DC at 20 °C	AC at 90 °C		Trefoil	Flat	Laid in ground			Laid in free air (Shaded)			
							Flat	Trefoil	Duct	Flat Touched	Trefoil Touched		
		mm ²	Ω/Km		Ω/Km	μf/km	mh/km	A	A	A	A		

1 Core - Cu/XLPE/ATA/PVC

CXB-T101-B12	25	0.727	0.9271	0.2520	0.4504	0.4966	468	160	132	160	163	20	645
CXB-T101-B13	35	0.524	0.6683	0.2832	0.4283	0.4745	203	207	159	194	199	21.3	775
CXB-T101-B14	50	0.387	0.4937	0.3200	0.3968	0.4430	238	238	189	235	239	22.6	925
CXB-T101-B15	70	0.268	0.3421	0.3735	0.3713	0.4175	292	291	233	234	298	24.5	1175
CXB-T101-B16	95	0.193	0.2467	0.4072	0.3584	0.4046	349	347	279	292	362	25.7	1435
CXB-T101-B17	120	0.153	0.1959	0.4464	0.3471	0.3933	397	394	319	364	417	27.3	1715
CXB-T101-B18	150	0.124	0.1592	0.4856	0.3362	0.3824	444	440	360	409	473	28.7	1995
CXB-T101-B19	185	0.0991	0.1278	0.5331	0.3236	0.3698	502	495	410	465	542	30.6	2400
CXB-T101-B20	240	0.0754	0.0981	0.6001	0.3117	0.3579	580	569	479	632	637	33.2	3005
CXB-T101-B30	300	0.0601	0.0792	0.6492	0.3028	0.3490	654	637	546	727	729	36.2	3640
CXB-T101-B40	400	0.047	0.0632	0.6722	0.2949	0.3412	740	714	623	839	835	39.2	4515
CXB-T101-B50	500	0.0366	0.0509	0.7107	0.2879	0.3342	833	794	712	968	953	43.4	5735
CXB-T101-B60	630	0.0283	0.0415	0.7908	0.2808	0.3270	931	874	804	1106	1073	47.3	7135
CXB-T101-B70	800	0.0221	0.0348	0.8917	0.2727	0.3189	1025	947	896	1249	1192	52	9050

1 Core - AL/XLPE/ATA/PVC

AXB-T101-B12	25	1.2	1.5386	0.2520	0.4504	0.4966	131	131	103	124	127	20	495
AXB-T101-B13	35	0.868	1.1130	0.2832	0.4283	0.4745	157	156	123	151	154	21.3	570
AXB-T101-B14	50	0.641	0.8220	0.3200	0.3968	0.4430	185	185	147	181	186	22.6	640
AXB-T101-B15	70	0.443	0.5682	0.3651	0.3748	0.4210	227	226	185	226	232	24.2	745
AXB-T101-B16	95	0.32	0.4106	0.4072	0.3584	0.4046	271	270	217	275	282	25.7	860
AXB-T101-B17	120	0.253	0.3249	0.4464	0.3471	0.3933	309	307	248	318	325	27.3	985
AXB-T101-B18	150	0.206	0.2648	0.4856	0.3362	0.3824	345	343	280	361	369	28.7	1105
AXB-T101-B19	185	0.164	0.2111	0.5331	0.3236	0.3698	391	388	320	417	425	30.6	1270
AXB-T101-B20	240	0.125	0.1614	0.5973	0.3122	0.3584	453	449	374	493	502	33.1	1510
AXB-T101-B30	300	0.1	0.1298	0.6412	0.3035	0.3497	513	505	427	569	576	35.9	1785
AXB-T101-B40	400	0.0778	0.1018	0.6672	0.2939	0.3401	586	574	494	665	670	39	2140
AXB-T101-B50	500	0.0605	0.0803	0.7084	0.2892	0.3354	669	648	571	777	776	43.5	2645
AXB-T101-B60	630	0.0469	0.0637	0.7896	0.2815	0.3277	759	727	679	901	891	47.4	3220
AXB-T101-B70	800	0.0367	0.0517	0.9010	0.2719	0.3181	853	807	747	1041	1016	52.4	3950

The above data is approximate and subjected to manufacturing tolerance this data is applicable also for 3.8/6.6 KV

3.6/6 (7.2) KV Multi Core STA Cables

Three Core Cables, with stranded circular copper or Aluminum conductors, XLPE insulated, Steel tape armoured and PVC Sheath.

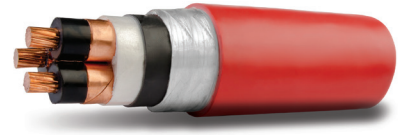

Description

- Stranded circular compacted copper or aluminum conductor, Semi-conducting layer as conductor screen, XLPE insulated, semi-conducting layer as non metallic insulation screen, copper tape or wire as metallic insulation screen, cores are assembled together with non hygroscopic polypropylene fillers and wrapped with binder tape, covered with a layer of PVC compound as bedding, steel tape armoured and PVC sheathed.
- Cables are produced according to IEC 60502.

Application

- These cables are generally suitable for direct burial or for installation on trays or in ducts.

Product Code	Nominal Cross sectional area mm ²	Max. Conductor Resistance		Capacitance µf/km	Inductance mh/km	Current Rating			Approx. Overall Diameter mm	Approx. Weight Kg/Km
		DC at 20 °C Ω/Km	AC at 90 °C Ω/Km			Ground A	Duct A	Laid in free air (Shaded) A		
3 Core - Cu/XLPE/STA/PVC										
CXB-T103-G12	25	0.727	0.9272	0.2520	0.3746	157	122	146	37.2	2220
CXB-T103-G13	35	0.524	0.6684	0.2832	0.3555	188	146	177	39.8	2625
CXB-T103-G14	50	0.387	0.4938	0.3200	0.3291	223	174	212	42.8	3150
CXB-T103-G15	70	0.268	0.3423	0.3735	0.3100	273	216	265	47.3	4005
CXB-T103-G16	95	0.193	0.2470	0.4072	0.3007	325	258	319	50.1	4870
CXB-T103-G17	120	0.153	0.1963	0.4464	0.2916	368	294	365	53.5	5775
CXB-T103-G18	150	0.124	0.1596	0.4856	0.2840	412	331	414	56.7	6715
CXB-T103-G19	185	0.0991	0.1283	0.5331	0.2736	465	375	473	60.6	7990
CXB-T103-G20	240	0.0754	0.0989	0.6001	0.2649	535	433	553	66.4	9980
CXB-T103-G30	300	0.0601	0.0801	0.6492	0.2593	599	490	630	72.8	12060
CXB-T103-G40	400	0.047	0.0644	0.6722	0.2556	674	560	721	81.5	15820
CXB-T103-G50	500	0.0366	0.0523	0.7107	0.2510	754	634	822	90.1	19790
3 Core - AL/XLPE/STA/PVC										
AXB-T103-G12	25	1.2	1.5386	0.2520	0.3746	122	95	113	37.2	1770
AXB-T103-G13	35	0.868	1.1130	0.2832	0.3555	146	113	137	39.8	2010
AXB-T103-G14	50	0.641	0.8220	0.3200	0.3291	173	135	165	42.8	2295
AXB-T103-G15	70	0.443	0.5683	0.3651	0.3127	212	167	205	46.7	2720
AXB-T103-G16	95	0.32	0.4108	0.4072	0.3007	253	201	248	50.1	3140
AXB-T103-G17	120	0.253	0.3251	0.4464	0.2916	287	229	285	53.5	3585
AXB-T103-G18	150	0.206	0.2650	0.4856	0.2840	322	258	323	56.7	4040
AXB-T103-G19	185	0.164	0.2115	0.5331	0.2736	365	294	371	60.6	4600
AXB-T103-G20	240	0.125	0.1619	0.5973	0.2652	421	342	435	66.2	5495
AXB-T103-G30	300	0.1	0.1304	0.6412	0.2596	475	389	498	72.2	6485
AXB-T103-G40	400	0.0778	0.1026	0.6672	0.2543	541	450	578	81.1	8680
AXB-T103-G50	500	0.0605	0.0812	0.7084	0.2523	615	518	670	90.3	10525

The above data is approximate and subjected to manufacturing tolerance
this data is applicable also for 3.8/6.6 KV

3.6/6 (7.2) KV Single Core AWA Cables

Single Core Cables, with stranded Circular copper or Aluminum conductors, XLPE insulated, aluminum wire armoured and PVC Sheath.



Description

- Stranded circular compacted copper or aluminum conductor, Semi-conducting layer as conductor screen, XLPE insulated, semi-conducting layer as non metallic insulation screen, copper tape or wire as metallic insulation screen, covered with a layer of PVC compound as bedding layer, aluminum wire armoured and PVC sheath.
- Cables are produced according to IEC 60502 or BS 6622.

Application

- These cables are generally suitable for direct burial or for installation on trays or in ducts.

Product Code	Nominal Cross sectional area	Max. Conductor Resistance		Capacitance	Inductance		Current Rating					Approx. Overall Diameter	Approx. Weight
		DC at 20 °C	AC at 90 °C		Trefoil	Flat	Laid in ground			Laid in free air (Shaded)			
							Flat	Trefoil	Duct	Flat Touched	Trefoil Touched		
		mm ²	Ω/Km		Ω/Km	µf/km	mh/km	A	A	A	A		
1 Core - Cu/XLPE/AWA/PVC													
CXB-T101-X12	25	0.727	0.9271	0.2520	0.4704	0.5166	169	169	134	163	166	22.1	765
CXB-T101-X13	35	0.524	0.6683	0.2832	0.4454	0.4916	202	202	161	198	202	23.2	885
CXB-T101-X14	50	0.387	0.4937	0.3200	0.4129	0.4592	239	238	191	238	242	24.5	1045
CXB-T101-X15	70	0.268	0.3421	0.3735	0.3862	0.4324	292	290	235	295	299	26.4	1300
CXB-T101-X16	95	0.193	0.2467	0.4072	0.3741	0.4203	348	344	281	357	360	27.8	1580
CXB-T101-X17	120	0.153	0.1959	0.4464	0.3605	0.4068	392	389	319	410	411	29.2	1860
CXB-T101-X18	150	0.124	0.1591	0.4856	0.3503	0.3965	438	433	359	465	463	30.8	2160
CXB-T101-X19	185	0.0991	0.1277	0.5331	0.3399	0.3862	491	482	405	532	523	33.2	2620
CXB-T101-X20	240	0.0754	0.0979	0.6001	0.3256	0.3718	562	544	468	622	604	35.6	3230
CXB-T101-X30	300	0.0601	0.0790	0.6492	0.3156	0.3618	628	598	527	709	679	38.6	3885
CXB-T101-X40	400	0.047	0.0630	0.6722	0.3078	0.3540	702	656	595	808	762	41.8	4795
CXB-T101-X50	500	0.0366	0.0505	0.7107	0.3039	0.3501	763	689	658	909	830	47	6195
CXB-T101-X60	630	0.0283	0.0410	0.7908	0.2954	0.3417	836	741	729	1019	911	50.9	7635
CXB-T101-X70	800	0.0221	0.0343	0.8917	0.2861	0.3323	904	786	798	1130	991	55.6	9595
1 Core - AL/XLPE/AWA/PVC													
AXB-T101-X12	25	1.2	1.5386	0.2520	0.4704	0.5166	132	132	104	127	130	22.1	615
AXB-T101-X13	35	0.868	1.1130	0.2832	0.4454	0.4916	157	157	125	154	157	23.2	680
AXB-T101-X14	50	0.641	0.8220	0.3200	0.4129	0.4592	186	186	149	185	188	24.5	760
AXB-T101-X15	70	0.443	0.5682	0.3651	0.3899	0.4362	228	227	183	230	234	26.1	875
AXB-T101-X16	95	0.32	0.4106	0.4072	0.3741	0.4203	271	269	219	279	283	27.8	1005
AXB-T101-X17	120	0.253	0.3248	0.4464	0.3605	0.4068	307	306	250	321	325	29.2	1130
AXB-T101-X18	150	0.206	0.2647	0.4856	0.3503	0.3965	343	341	281	364	367	30.8	1270
AXB-T101-X19	185	0.164	0.2110	0.5331	0.3399	0.3862	387	383	320	419	419	33.2	1490
AXB-T101-X20	240	0.125	0.1614	0.5973	0.3262	0.3724	446	440	371	493	488	35.5	1740
AXB-T101-X30	300	0.1	0.1297	0.6412	0.3164	0.3627	502	491	421	564	554	38.3	2025
AXB-T101-X40	400	0.0778	0.1017	0.6672	0.3068	0.3530	567	548	482	653	633	41.6	2415
AXB-T101-X50	500	0.0605	0.0800	0.7084	0.3051	0.3513	632	594	546	750	710	47.1	3105
AXB-T101-X60	630	0.0469	0.0634	0.7896	0.2962	0.3424	706	650	616	856	795	51	3715
AXB-T101-X70	800	0.0367	0.0514	0.9010	0.2852	0.3314	781	704	689	973	886	56	4505

The above data is approximate and subjected to manufacturing tolerance this data is applicable also for 3.8/6.6 KV

3.6/6 (7.2) KV Multi Core SWA Cables

Three Core Cables, with stranded circular copper or Aluminum conductors, XLPE insulated, Steel wire armoured and PVC Sheath.



Description

- Stranded circular compacted copper or aluminum conductor, Semi-conducting layer as conductor screen, XLPE insulated, semi-conducting layer as non metallic insulation screen, copper tape or wire as metallic insulation screen, cores are assembled together with non hygroscopic polypropylene fillers and wrapped with binder tape, covered with a layer of PVC compound as bedding, steel wire armoured and PVC sheathed.
- Cables are produced according to IEC 60502 or BS 6622.

Application

- These cables are generally suitable for direct burial or for installation on trays or in ducts.

Product Code	Nominal Cross sectional area	Max. Conductor Resistance		Capacitance	Inductance	Current Rating			Approx. Overall Diameter	Approx. Weight
		DC at 20 °C	AC at 90 °C			Ground	Duct	Laid in free air (Shaded)		
		mm ²	Ω/Km							
3 Core - Cu/XLPE/SWA/PVC										
CXB-T103-W12	25	0.727	0.9272	0.2520	0.3746	159	123	149	39.7	2935
CXB-T103-W13	35	0.524	0.6684	0.2832	0.3555	190	149	180	43	3825
CXB-T103-W14	50	0.387	0.4938	0.3200	0.3291	225	177	216	46	4435
CXB-T103-W15	70	0.268	0.3423	0.3735	0.3100	275	219	269	50.5	5430
CXB-T103-W16	95	0.193	0.2470	0.4072	0.3007	327	260	324	53.3	6380
CXB-T103-W17	120	0.153	0.1963	0.4464	0.2916	370	298	370	56.7	7360
CXB-T103-W18	150	0.124	0.1596	0.4856	0.2840	414	333	419	59.9	8420
CXB-T103-W19	185	0.0991	0.1283	0.5331	0.2736	467	378	478	63.8	9810
CXB-T103-W20	240	0.0754	0.0989	0.6001	0.2649	535	438	561	71.3	12720
CXB-T103-W30	300	0.0601	0.0801	0.6492	0.2593	596	493	635	77.9	15130
CXB-T103-W40	400	0.047	0.0644	0.6722	0.2556	663	553	717	85.2	18395
CXB-T103-W50	500	0.0366	0.0523	0.7107	0.2510	734	620	808	94	22720
3 Core - AL/XLPE/SWA/PVC										
AXB-T103-W12	25	1.2	1.5386	0.2520	0.3746	123	96	115	39.7	2485
AXB-T103-W13	35	0.868	1.1130	0.2832	0.3555	147	115	140	43	3210
AXB-T103-W14	50	0.641	0.8220	0.3200	0.3291	174	137	168	46	3580
AXB-T103-W15	70	0.443	0.5683	0.3651	0.3127	213	169	208	49.9	4110
AXB-T103-W16	95	0.32	0.4108	0.4072	0.3007	255	202	252	53.3	4650
AXB-T103-W17	120	0.253	0.3251	0.4464	0.2916	289	232	289	56.7	5170
AXB-T103-W18	150	0.206	0.2650	0.4856	0.2840	323	260	327	59.9	5745
AXB-T103-W19	185	0.164	0.2115	0.5331	0.2736	366	297	375	63.8	6420
AXB-T103-W20	240	0.125	0.1619	0.5973	0.2652	423	347	443	71.1	8240
AXB-T103-W30	300	0.1	0.1304	0.6412	0.2596	475	393	504	77.3	9500
AXB-T103-W40	400	0.0778	0.1026	0.6672	0.2543	537	448	578	84.8	11265
AXB-T103-W50	500	0.0605	0.0812	0.7084	0.2523	605	511	665	94.2	13450

The above data is approximate and subjected to manufacturing tolerance
this data is applicable also for 3.8/6.6 KV

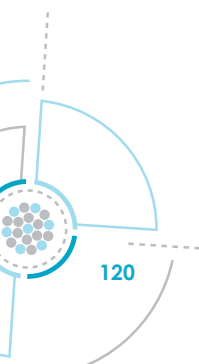

6/10 (12) KV Single Core Unarmoured Cables

Single Core Cables, with stranded circular copper or Aluminum conductors, XLPE insulated, and PVC Sheath.



Description

- Stranded circular compacted copper or aluminum conductor, Semi-conducting layer as conductor screen, XLPE insulated, semi-conducting layer as non metallic insulation screen, copper tape or wire as metallic insulation screen, and PVC sheathed.
- Cables are produced according to IEC 60502.

Application

- These cables are generally suitable for direct burial or for installation on trays or in ducts.

Product Code	Nominal Cross sectional area	Max. Conductor Resistance		Capacitance	Inductance		Current Rating					Approx. Overall Diameter	Approx. Weight
		DC at 20 °C	AC at 90 °C		Trefoil	Flat	Laid in ground			Laid in free air (Shaded)			
							Flat	Trefoil	Duct	Flat Touched	Trefoil Touched		
		mm ²	Ω/Km		Ω/Km	μf/km	mh/km	A	A	A	A		
1 Core - Cu/XLPE/PVC													
CX2-T101-U12	25	0.727	0.9271	0.2094	0.4226	0.4688	168	172	127	155	159	17.4	500
CX2-T101-U13	35	0.524	0.6684	0.2341	0.4001	0.4463	201	207	152	189	193	18.5	610
CX2-T101-U14	50	0.387	0.4938	0.2630	0.3703	0.4166	238	245	183	227	233	19.8	750
CX2-T101-U15	70	0.268	0.3422	0.3051	0.3488	0.3950	292	292	227	287	295	21.9	990
CX2-T101-U16	95	0.193	0.2468	0.3315	0.3370	0.3833	347	347	272	347	356	23.1	1240
CX2-T101-U17	120	0.153	0.1960	0.3623	0.3271	0.3733	395	394	314	401	412	24.7	1505
CX2-T101-U18	150	0.124	0.1593	0.3931	0.3172	0.3634	443	441	355	457	466	26.1	1775
CX2-T101-U19	185	0.0991	0.1279	0.4303	0.3059	0.3521	501	498	412	526	536	28	2165
CX2-T101-U20	240	0.0754	0.0983	0.4828	0.2953	0.3416	580	575	476	625	634	30.6	2745
CX2-T101-U30	300	0.0601	0.0794	0.5396	0.2855	0.3317	654	646	544	721	729	33.2	3330
CX2-T101-U40	400	0.047	0.0636	0.5963	0.2790	0.3252	741	727	621	830	840	36.2	4190
CX2-T101-U50	500	0.0366	0.0515	0.6703	0.2696	0.3158	837	815	709	961	966	39.6	5305
CX2-T101-U60	630	0.0283	0.0421	0.7455	0.2640	0.3102	936	904	806	1101	1098	43.5	6670
CX2-T101-U70	800	0.0221	0.0355	0.8401	0.2575	0.3037	1033	988	903	1248	1234	48.2	8535
1 Core - AL/XLPE/PVC													
AX2-T101-U12	25	1.2	1.5386	0.2094	0.4226	0.4688	130	133	98	120	126	17.4	350
AX2-T101-U13	35	0.868	1.1130	0.2341	0.4001	0.4463	156	160	119	145	153	18.5	400
AX2-T101-U14	50	0.641	0.8220	0.2630	0.3703	0.4166	185	189	142	176	184	19.8	465
AX2-T101-U15	70	0.443	0.5682	0.2985	0.3521	0.3983	226	225	177	225	231	21.6	565
AX2-T101-U16	95	0.32	0.4107	0.3315	0.3370	0.3833	271	278	212	273	276	23.1	665
AX2-T101-U17	120	0.253	0.3249	0.3623	0.3271	0.3733	308	317	244	316	324	24.7	775
AX2-T101-U18	150	0.206	0.2648	0.3931	0.3172	0.3634	346	350	276	354	365	26.1	885
AX2-T101-U19	185	0.164	0.2112	0.4303	0.3059	0.3521	393	395	315	414	426	28	1035
AX2-T101-U20	240	0.125	0.1616	0.4806	0.2958	0.3420	456	455	377	487	497	30.5	1255
AX2-T101-U30	300	0.1	0.1299	0.5330	0.2860	0.3323	513	511	424	563	575	32.9	1475
AX2-T101-U40	400	0.0778	0.1021	0.5919	0.2779	0.3241	587	579	492	657	669	36	1815
AX2-T101-U50	500	0.0605	0.0806	0.6682	0.2709	0.3171	671	661	572	771	782	39.7	2215
AX2-T101-U60	630	0.0469	0.0641	0.7444	0.2648	0.3110	762	770	657	896	904	43.6	2750
AX2-T101-U70	800	0.0367	0.0522	0.8488	0.2568	0.3031	858	885	750	1036	1037	48.6	3430

The above data is approximate and subjected to manufacturing tolerance this data is applicable also for 6.35/11 KV

6/10 (12) KV Multi Core Unarmoured Cables

Three Core Cables, with stranded circular copper or Aluminum conductors, XLPE insulated, and PVC Sheath.



Description

- Stranded circular compacted copper or aluminum conductor, Semi-conducting layer as conductor screen, XLPE insulated, semi-conducting layer as non metallic insulation screen, copper tape or wire as metallic insulation screen, cores are assembled together with non hygroscopic polypropylene fillers and wrapped with binder tape, and PVC sheathed.
- Cables are produced according to IEC 60502.

Application

- These cables are generally suitable for direct burial or for installation on trays or in ducts.

Product Code	Nominal Cross sectional area	Max. Conductor Resistance		Capacitance	Inductance	Current Rating			Approx. Overall Diameter	Approx. Weight
		DC at 20 °C	AC at 90 °C			Ground	Duct	Laid in free air (Shaded)		
		Ω/Km	Ω/Km							
mm ²	Ω/Km	Ω/Km	μf/km	mh/km	A	A	A	mm	Kg/Km	
3 Core - Cu/XLPE/PVC										
CX2-T103-U12	25	0.727	0.9271	0.2094	0.3952	167	125	154	36	1640
CX2-T103-U13	35	0.524	0.6684	0.2341	0.3746	197	148	182	38.6	2000
CX2-T103-U14	50	0.387	0.4938	0.2630	0.3466	233	177	220	41.6	2475
CX2-T103-U15	70	0.268	0.3423	0.3051	0.3257	286	219	275	45.9	3230
CX2-T103-U16	95	0.193	0.2469	0.3315	0.3154	343	263	336	48.7	4045
CX2-T103-U17	120	0.153	0.1962	0.3623	0.3053	390	302	388	51.9	4865
CX2-T103-U18	150	0.124	0.1595	0.3931	0.2968	438	341	442	55.2	5750
CX2-T103-U19	185	0.0991	0.1282	0.4303	0.2856	496	388	508	59	6950
CX2-T103-U20	240	0.0754	0.0987	0.4828	0.2757	575	454	601	64.6	8805
CX2-T103-U30	300	0.0601	0.0799	0.5396	0.2678	655	523	706	70.6	10720
CX2-T103-U40	400	0.047	0.0642	0.5963	0.2607	732	590	794	76.7	13390
CX2-T103-U50	500	0.0366	0.0522	0.6703	0.2533	825	672	916	84.4	16985
3 Core - AL/XLPE/PVC										
AX2-T103-U12	25	1.2	1.5386	0.2094	0.3952	129	97	120	36	1190
AX2-T103-U13	35	0.868	1.1130	0.2341	0.3746	152	115	141	38.6	1380
AX2-T103-U14	50	0.641	0.8220	0.2630	0.3466	181	137	171	41.6	1620
AX2-T103-U15	70	0.443	0.5683	0.2985	0.3286	222	170	214	45.3	1955
AX2-T103-U16	95	0.32	0.4108	0.3315	0.3154	266	204	260	48.7	2315
AX2-T103-U17	120	0.253	0.3250	0.3623	0.3053	303	234	301	51.9	2675
AX2-T103-U18	150	0.206	0.2650	0.3931	0.2968	340	265	343	55.2	3070
AX2-T103-U19	185	0.164	0.2114	0.4303	0.2856	386	303	396	59	3560
AX2-T103-U20	240	0.125	0.1618	0.4806	0.2761	449	355	470	64.4	4325
AX2-T103-U30	300	0.1	0.1302	0.5330	0.2681	509	406	542	70	5160
AX2-T103-U40	400	0.0778	0.1025	0.5919	0.2594	582	469	633	76.2	6255
AX2-T103-U50	500	0.0605	0.0811	0.6682	0.2546	673	548	754	84.6	7710

The above data is approximate and subjected to manufacturing tolerance
this data is applicable also for 6.35/11 KV

6/10 (12) KV Single Core ATA Cables

Single Core Cables, with stranded Circular copper or Aluminum conductors, XLPE insulated, aluminum tape armoured and PVC Sheath.



Description

- Stranded circular compacted copper or aluminum conductor, Semi-conducting layer as conductor screen, XLPE insulated, semi-conducting layer as non metallic insulation screen, copper tape or wire as metallic insulation screen, covered with a layer of PVC compound as bedding layer, aluminum tape armoured and PVC sheath.
- Cables are produced according to IEC 60502.

Application

- These cables are generally suitable for direct burial or for installation on trays or in ducts.

Product Code	Nominal Cross sectional area	Max. Conductor Resistance		Capacitance	Inductance		Current Rating					Approx. Overall Diameter	Approx. Weight
		DC at 20 °C	AC at 90 °C		Laid in ground			Laid in free air (Shaded)					
					Trefoil	Flat	Flat Trefoil Duct	Flat Trefoil Touched	Trefoil Touched				
		mm ²	Ω/Km		Ω/Km	µf/km	mh/km	Flat Trefoil Duct	Flat Trefoil Touched	Trefoil Touched	mm		

1 Core - Cu/XLPE/ATA/PVC

CX2-T101-B12	25	0.727	0.9271	0.2094	0.4658	0.5120	168	168	134	162	165	21.6	715
CX2-T101-B13	35	0.524	0.6683	0.2341	0.4410	0.4872	201	201	161	196	201	22.7	835
CX2-T101-B14	50	0.387	0.4937	0.2630	0.4088	0.4550	239	238	194	236	241	24	990
CX2-T101-B15	70	0.268	0.3421	0.3051	0.3824	0.4286	292	291	235	294	500	25.9	1240
CX2-T101-B16	95	0.193	0.2467	0.3315	0.3704	0.4167	349	347	282	357	364	27.3	1520
CX2-T101-B17	120	0.153	0.1959	0.3623	0.3571	0.4033	395	393	323	412	419	28.7	1785
CX2-T101-B18	150	0.124	0.1591	0.3931	0.3470	0.3932	444	439	374	468	476	30.3	2085
CX2-T101-B19	185	0.0991	0.1277	0.4303	0.3338	0.3800	501	494	413	537	544	32.2	2495
CX2-T101-B20	240	0.0754	0.0980	0.4828	0.3199	0.3661	580	569	482	634	640	34.6	3090
CX2-T101-B30	300	0.0601	0.0791	0.5396	0.3093	0.3555	654	636	548	729	731	37.4	3715
CX2-T101-B40	400	0.047	0.0631	0.5963	0.3000	0.3462	739	713	625	840	835	40.2	4590
CX2-T101-B50	500	0.0366	0.0509	0.6703	0.2898	0.3360	833	794	713	969	953	43.8	5765
CX2-T101-B60	630	0.0283	0.0414	0.7455	0.2824	0.3287	931	874	805	1107	1074	47.7	7170
CX2-T101-B70	800	0.0221	0.0348	0.8401	0.2742	0.3204	1025	947	899	1250	1193	52.4	9085

1 Core - AL/XLPE/ATA/PVC

AX2-T101-B12	25	1.2	1.5386	0.2094	0.4658	0.5120	131	130	104	125	128	21.6	565
AX2-T101-B13	35	0.868	1.1130	0.2341	0.4410	0.4872	157	156	124	152	156	22.7	630
AX2-T101-B14	50	0.641	0.8220	0.2630	0.4088	0.4550	185	185	149	183	187	24	705
AX2-T101-B15	70	0.443	0.5682	0.2985	0.3861	0.4323	227	226	187	227	234	25.6	815
AX2-T101-B16	95	0.32	0.4106	0.3315	0.3704	0.4167	270	270	219	276	284	27.3	940
AX2-T101-B17	120	0.253	0.3248	0.3623	0.3571	0.4033	309	306	244	320	327	28.7	1055
AX2-T101-B18	150	0.206	0.2647	0.3931	0.3470	0.3932	344	342	282	363	370	30.3	1195
AX2-T101-B19	185	0.164	0.2111	0.4303	0.3338	0.3800	390	387	322	419	426	32.2	1365
AX2-T101-B20	240	0.125	0.1614	0.4806	0.3204	0.3667	452	448	377	495	503	34.5	1595
AX2-T101-B30	300	0.1	0.1297	0.5330	0.3101	0.3563	512	504	430	571	577	37.1	1860
AX2-T101-B40	400	0.0778	0.1018	0.5919	0.2990	0.3452	585	574	494	660	671	40	2215
AX2-T101-B50	500	0.0605	0.0803	0.6682	0.2910	0.3372	669	648	571	777	776	43.9	2675
AX2-T101-B60	630	0.0469	0.0637	0.7444	0.2832	0.3294	759	727	679	901	891	47.8	3250
AX2-T101-B70	800	0.0367	0.0517	0.8488	0.2734	0.3196	853	807	750	1041	1016	52.8	3990

The above data is approximate and subjected to manufacturing tolerance
this data is applicable also for 6.35/11 KV

6/10 (12) KV Multi Core STA Cables

Three Core Cables, with stranded circular copper or Aluminum conductors, XLPE insulated, Steel tape armoured and PVC Sheath.

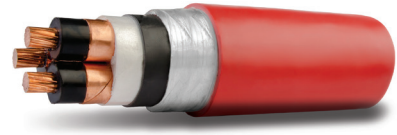

Description

- Stranded circular compacted copper or aluminum conductor, Semi-conducting layer as conductor screen, XLPE insulated, semi-conducting layer as non metallic insulation screen, copper tape or wire as metallic insulation screen, cores are assembled together with non hygroscopic polypropylene fillers and wrapped with binder tape, covered with a layer of PVC compound as bedding, steel tape armoured and PVC sheathed.
- Cables are produced according to IEC 60502.

Application

- These cables are generally suitable for direct burial or for installation on trays or in ducts.

Product Code	Nominal Cross sectional area mm ²	Max. Conductor Resistance		Capacitance µf/km	Inductance mh/km	Current Rating			Approx. Overall Diameter mm	Approx. Weight Kg/Km
		DC at 20 °C Ω/Km	AC at 90 °C Ω/Km			Ground A	Duct A	Laid in free air (Shaded) A		
3 Core - Cu/XLPE/STA/PVC										
CX2-T103-G12	25	0.727	0.9271	0.2094	0.3952	157	124	147	40.6	2480
CX2-T103-G13	35	0.524	0.6684	0.2341	0.3746	189	148	179	43	2870
CX2-T103-G14	50	0.387	0.4938	0.2630	0.3466	222	176	214	46.4	3455
CX2-T103-G15	70	0.268	0.3423	0.3051	0.3257	272	217	266	50.9	4335
CX2-T103-G16	95	0.193	0.2469	0.3315	0.3154	325	260	321	53.5	5190
CX2-T103-G17	120	0.153	0.1962	0.3623	0.3053	369	297	368	56.7	6085
CX2-T103-G18	150	0.124	0.1595	0.3931	0.2968	413	332	417	60	7040
CX2-T103-G19	185	0.0991	0.1282	0.4303	0.2856	464	377	475	64	8360
CX2-T103-G20	240	0.0754	0.0987	0.4828	0.2757	535	436	556	69.6	10345
CX2-T103-G30	300	0.0601	0.0799	0.5396	0.2678	598	493	632	75.8	12435
CX2-T103-G40	400	0.047	0.0642	0.5963	0.2607	675	561	724	83.3	16065
CX2-T103-G50	500	0.0366	0.0522	0.6703	0.2533	754	634	822	91.2	19965
3 Core - AL/XLPE/STA/PVC										
AX2-T103-G12	25	1.2	1.5386	0.2094	0.3952	122	96	115	40.6	2030
AX2-T103-G13	35	0.868	1.1130	0.2341	0.3746	146	115	139	43	2255
AX2-T103-G14	50	0.641	0.8220	0.2630	0.3466	173	136	166	46.4	2600
AX2-T103-G15	70	0.443	0.5683	0.2985	0.3286	211	169	206	50.3	3045
AX2-T103-G16	95	0.32	0.4108	0.3315	0.3154	253	202	249	53.5	3460
AX2-T103-G17	120	0.253	0.3250	0.3623	0.3053	288	231	287	56.7	3895
AX2-T103-G18	150	0.206	0.2650	0.3931	0.2968	322	259	326	60	4365
AX2-T103-G19	185	0.164	0.2114	0.4303	0.2856	364	296	372	64	4970
AX2-T103-G20	240	0.125	0.1618	0.4806	0.2761	421	344	437	69.4	5860
AX2-T103-G30	300	0.1	0.1302	0.5330	0.2681	474	391	499	75.2	6865
AX2-T103-G40	400	0.0778	0.1025	0.5919	0.2594	542	451	580	82.8	8915
AX2-T103-G50	500	0.0605	0.0811	0.6682	0.2546	615	518	670	91.4	10700

The above data is approximate and subjected to manufacturing tolerance
this data is applicable also for 6.35/11 KV

6/10 (12) KV Single Core AWA Cables

Single Core Cables, with stranded Circular copper or Aluminum conductors, XLPE insulated, aluminum wire armoured and PVC Sheath.



Description

- Stranded circular compacted copper or aluminum conductor, Semi-conducting layer as conductor screen, XLPE insulated, semi-conducting layer as non metallic insulation screen, copper tape or wire as metallic insulation screen, covered with a layer of PVC compound as bedding layer, aluminum wire armoured and PVC sheath.
- Cables are produced according to IEC 60502 or BS 6622.

Application

- These cables are generally suitable for direct burial or for installation on trays or in ducts.

Product Code	Nominal Cross sectional area	Max. Conductor Resistance		Capacitance	Inductance		Current Rating					Approx. Overall Diameter	Approx. Weight
		DC at 20 °C	AC at 90 °C		Trefoil	Flat	Laid in ground			Laid in free air (Shaded)			
							Flat	Trefoil	Duct	Flat Touched	Trefoil Touched		
		mm ²	Ω/Km		Ω/Km	µf/km	mh/km	A	A	A	A		
1 Core - Cu/XLPE/AWA/PVC													
CX2-T101-X12	25	0.727	0.9271	0.2094	0.4827	0.5289	169	169	136	164	168	23.5	825
CX2-T101-X13	35	0.524	0.6683	0.2341	0.4571	0.5033	202	202	163	199	203	24.6	955
CX2-T101-X14	50	0.387	0.4937	0.2630	0.4241	0.4703	239	238	193	239	243	25.9	1115
CX2-T101-X15	70	0.268	0.3421	0.3051	0.3980	0.4442	292	290	237	297	301	28	1390
CX2-T101-X16	95	0.193	0.2466	0.3315	0.3839	0.4301	346	344	283	359	362	29.2	1665
CX2-T101-X17	120	0.153	0.1958	0.3623	0.3744	0.4207	391	387	322	414	413	31.3	2000
CX2-T101-X18	150	0.124	0.1590	0.3931	0.3635	0.4097	437	431	361	468	465	32.9	2310
CX2-T101-X19	185	0.0991	0.1276	0.4303	0.3482	0.3944	491	481	408	534	525	34.6	2710
CX2-T101-X20	240	0.0754	0.0979	0.4828	0.3344	0.3806	562	543	471	624	605	37.2	3345
CX2-T101-X30	300	0.0601	0.0789	0.5396	0.3217	0.3680	628	597	530	711	681	39.8	3975
CX2-T101-X40	400	0.047	0.0628	0.5963	0.3171	0.3633	690	636	589	802	747	43.8	5025
CX2-T101-X50	500	0.0366	0.0505	0.6703	0.3056	0.3518	763	691	660	910	830	47.4	6225
CX2-T101-X60	630	0.0283	0.0410	0.7455	0.2970	0.3432	835	739	729	1019	909	51.3	7680
CX2-T101-X70	800	0.0221	0.0343	0.8401	0.2875	0.3337	905	784	798	1130	992	56	9640
1 Core - AL/XLPE/AWA/PVC													
AX2-T101-X12	25	1.2	1.5386	0.2094	0.4827	0.5289	131	131	105	128	131	23.5	675
AX2-T101-X13	35	0.868	1.1130	0.2341	0.4571	0.5033	157	157	126	155	158	24.6	745
AX2-T101-X14	50	0.641	0.8220	0.2630	0.4241	0.4703	186	185	150	186	190	25.9	830
AX2-T101-X15	70	0.443	0.5682	0.2985	0.4018	0.4481	227	226	184	232	236	27.7	960
AX2-T101-X16	95	0.32	0.4106	0.3315	0.3839	0.4301	270	269	221	280	284	29.2	1085
AX2-T101-X17	120	0.253	0.3248	0.3623	0.3744	0.4207	307	305	252	324	327	31.3	1270
AX2-T101-X18	150	0.206	0.2647	0.3931	0.3635	0.4097	342	340	283	367	369	32.9	1415
AX2-T101-X19	185	0.164	0.2110	0.4303	0.3482	0.3944	387	383	322	420	420	34.6	1580
AX2-T101-X20	240	0.125	0.1613	0.4806	0.3350	0.3812	446	439	374	494	490	37.1	1850
AX2-T101-X30	300	0.1	0.1296	0.5330	0.3226	0.3688	500	490	423	566	555	39.5	2115
AX2-T101-X40	400	0.0778	0.1016	0.5919	0.3162	0.3624	561	537	480	652	626	43.6	2635
AX2-T101-X50	500	0.0605	0.0800	0.6682	0.3067	0.3530	631	593	546	750	707	47.5	3145
AX2-T101-X60	630	0.0469	0.0634	0.7444	0.2977	0.3439	705	650	616	856	794	51.4	3760
AX2-T101-X70	800	0.0367	0.0513	0.8488	0.2866	0.3328	781	705	691	974	886	56.4	4540

The above data is approximate and subjected to manufacturing tolerance this data is applicable also for 6.35/11 KV

6/10 (12) KV Multi Core SWA Cables

Three Core Cables, with stranded circular copper or Aluminum conductors, XLPE insulated, Steel wire armoured and PVC Sheath.



Description

- Stranded circular compacted copper or aluminum conductor, Semi-conducting layer as conductor screen, XLPE insulated, semi-conducting layer as non metallic insulation screen, copper tape or wire as metallic insulation screen, cores are assembled together with non hygroscopic polypropylene fillers and wrapped with binder tape, covered with a layer of PVC compound as bedding, steel wire armoured and PVC sheathed.
- Cables are produced according to IEC 60502 or BS 6622.

Application

- These cables are generally suitable for direct burial or for installation on trays or in ducts.

Product Code	Nominal Cross sectional area	Max. Conductor Resistance		Capacitance	Inductance	Current Rating			Approx. Overall Diameter	Approx. Weight
		DC at 20 °C	AC at 90 °C			Ground	Duct	Laid in free air (Shaded)		
3 Core - Cu/XLPE/SWA/PVC										
CX2-T103-W12	25	0.727	0.9271	0.2094	0.3952	158	126	150	43.8	3710
CX2-T103-W13	35	0.524	0.6684	0.2341	0.3746	190	150	182	46.4	4175
CX2-T103-W14	50	0.387	0.4938	0.2630	0.3466	224	178	217	49.6	4855
CX2-T103-W15	70	0.268	0.3423	0.3051	0.3257	275	221	271	53.9	5815
CX2-T103-W16	95	0.193	0.2469	0.3315	0.3154	327	264	326	56.7	6775
CX2-T103-W17	120	0.153	0.1962	0.3623	0.3053	370	299	373	59.9	7790
CX2-T103-W18	150	0.124	0.1595	0.3931	0.2968	415	336	423	63.2	8825
CX2-T103-W19	185	0.0991	0.1282	0.4303	0.2856	466	381	480	67.2	10295
CX2-T103-W20	240	0.0754	0.0987	0.4828	0.2757	534	440	561	74.9	13305
CX2-T103-W30	300	0.0601	0.0799	0.5396	0.2678	595	495	635	80.9	15665
CX2-T103-W40	400	0.047	0.0642	0.5963	0.2607	663	556	718	87.2	18765
CX2-T103-W50	500	0.0366	0.0522	0.6703	0.2533	733	619	808	95.1	22935
3 Core - AL/XLPE/SWA/PVC										
AX2-T103-W12	25	1.2	1.5386	0.2094	0.3952	123	98	117	43.8	3260
AX2-T103-W13	35	0.868	1.1130	0.2341	0.3746	147	117	141	46.4	3555
AX2-T103-W14	50	0.641	0.8220	0.2630	0.3466	174	138	169	49.6	4000
AX2-T103-W15	70	0.443	0.5683	0.2985	0.3286	213	170	209	53.3	4530
AX2-T103-W16	95	0.32	0.4108	0.3315	0.3154	254	205	253	56.7	5045
AX2-T103-W17	120	0.253	0.3250	0.3623	0.3053	289	233	291	59.9	5600
AX2-T103-W18	150	0.206	0.2650	0.3931	0.2968	324	262	330	63.2	6150
AX2-T103-W19	185	0.164	0.2114	0.4303	0.2856	365	299	376	67.2	6905
AX2-T103-W20	240	0.125	0.1618	0.4806	0.2761	422	348	443	74.7	8820
AX2-T103-W30	300	0.1	0.1302	0.5330	0.2681	474	394	504	80.3	10035
AX2-T103-W40	400	0.0778	0.1025	0.5919	0.2594	536	450	579	86.7	11560
AX2-T103-W50	500	0.0605	0.0811	0.6682	0.2546	605	511	664	95.3	13670

The above data is approximate and subjected to manufacturing tolerance
this data is applicable also for 6.35/11 KV

8.7/15 (17.5) KV Single Core Unarmoured Cables

Single Core Cables, with stranded Circular copper or Aluminum conductors, XLPE insulated, and PVC Sheath.



Description

- Stranded circular compacted copper or aluminum conductor, Semi-conducting layer as conductor screen, XLPE insulated, semi-conducting layer as non metallic insulation screen, copper tape or wire as metallic insulation screen, and PVC sheathed.
- Cables are produced according to IEC 60502.

Application

- These cables are generally suitable for direct burial or for installation on trays or in ducts.

Product Code	Nominal Cross sectional area	Max. Conductor Resistance		Capacitance	Inductance		Current Rating					Approx. Overall Diameter	Approx. Weight
		DC at 20 °C	AC at 90 °C		Laid in ground			Laid in free air (Shaded)					
					Trefoil	Flat	Flat Trefoil Duct	Flat Trefoil Touched	Trefoil Touched				
		mm ²	Ω/Km		Ω/Km	µf/km	mh/km	A	A	A	A		
1 Core - Cu/XLPE/PVC													
CX3-T101-U12	25	0.727	0.9271	0.1699	0.4464	0.4926	168	172	127	155	159	19.6	570
CX3-T101-U13	35	0.524	0.6683	0.1886	0.4245	0.4707	201	207	152	189	193	20.9	690
CX3-T101-U14	50	0.387	0.4937	0.2104	0.3932	0.4394	238	245	183	227	234	22.2	840
CX3-T101-U15	70	0.268	0.3422	0.2421	0.3696	0.4158	292	295	227	287	295	24.3	1085
CX3-T101-U16	95	0.193	0.2467	0.2620	0.3568	0.4030	347	351	272	347	356	25.5	1345
CX3-T101-U17	120	0.153	0.1959	0.2851	0.3456	0.3918	395	398	314	403	412	27.1	1615
CX3-T101-U18	150	0.124	0.1592	0.3081	0.3348	0.3810	443	445	355	458	466	28.5	1890
CX3-T101-U19	185	0.0991	0.1278	0.3360	0.3223	0.3685	501	502	412	527	536	30.4	2285
CX3-T101-U20	240	0.0754	0.0981	0.3752	0.3104	0.3567	580	578	478	626	634	33	2875
CX3-T101-U30	300	0.0601	0.0792	0.4177	0.2994	0.3457	658	648	547	723	731	35.6	3470
CX3-T101-U40	400	0.047	0.0633	0.4600	0.2908	0.3370	746	726	623	830	841	38.4	4325
CX3-T101-U50	500	0.0366	0.0511	0.5153	0.2814	0.3276	840	817	711	962	968	42	5470
CX3-T101-U60	630	0.0283	0.0417	0.5713	0.2739	0.3201	940	906	806	1102	1098	45.7	6825
CX3-T101-U70	800	0.0221	0.0351	0.6419	0.2672	0.3134	1035	988	903	1248	1234	50.6	8730
1 Core - AL/XLPE/PVC													
AX3-T101-U12	25	1.2	1.5386	0.1699	0.4464	0.4926	132	133	102	120	126	19.6	420
AX3-T101-U13	35	0.868	1.1130	0.1886	0.4245	0.4707	158	160	123	145	153	20.9	485
AX3-T101-U14	50	0.641	0.8220	0.2104	0.3932	0.4394	188	189	146	179	184	22.2	555
AX3-T101-U15	70	0.443	0.5682	0.2371	0.3732	0.4194	228	229	181	225	231	24	660
AX3-T101-U16	95	0.32	0.4106	0.2620	0.3568	0.4030	275	278	216	273	280	25.5	770
AX3-T101-U17	120	0.253	0.3249	0.2851	0.3456	0.3918	312	320	249	316	324	27.1	885
AX3-T101-U18	150	0.206	0.2648	0.3081	0.3348	0.3810	350	354	280	359	369	28.5	995
AX3-T101-U19	185	0.164	0.2111	0.3360	0.3223	0.3685	396	398	319	414	426	30.4	1155
AX3-T101-U20	240	0.125	0.1615	0.3736	0.3109	0.3572	460	459	377	491	505	32.9	1385
AX3-T101-U30	300	0.1	0.1298	0.4128	0.3001	0.3463	517	515	429	566	580	35.3	1615
AX3-T101-U40	400	0.0778	0.1019	0.4568	0.2898	0.3360	591	584	497	661	675	38.2	1950
AX3-T101-U50	500	0.0605	0.0804	0.5137	0.2826	0.3288	675	667	575	773	790	42.1	2380
AX3-T101-U60	630	0.0469	0.0639	0.5705	0.2746	0.3209	768	778	660	901	912	45.8	2910
AX3-T101-U70	800	0.0367	0.0519	0.6484	0.2665	0.3127	863	890	760	1042	1042	51	3630

The above data is approximate and subjected to manufacturing tolerance

8.7/15 (17.5) KV Multi Core Unarmoured Cables

Three Core Cables, with stranded circular copper or Aluminum conductors, XLPE insulated, and PVC Sheath.



Description

- Stranded circular compacted copper or aluminum conductor, Semi-conducting layer as conductor screen, XLPE insulated, semi-conducting layer as non metallic insulation screen, copper tape or wire as metallic insulation screen, cores are assembled together with non hygroscopic polypropylene fillers and wrapped with binder tape, and PVC sheathed.
- Cables are produced according to IEC 60502.

Application

- These cables are generally suitable for direct burial or for installation on trays or in ducts.

Product Code	Nominal Cross sectional area	Max. Conductor Resistance		Capacitance	Inductance	Current Rating			Approx. Overall Diameter	Approx. Weight
		DC at 20 °C	AC at 90 °C			Ground	Duct	Laid in free air (Shaded)		
		Ω/Km	Ω/Km							
mm ²	Ω/Km	Ω/Km	μf/km	mh/km	A	A	A	mm	Kg/Km	
3 Core - Cu/XLPE/PVC										
CX3-T103-U12	25	0.727	0.9271	0.1699	0.4238	167	128	158	41.2	1940
CX3-T103-U13	35	0.524	0.6684	0.1886	0.4014	197	152	187	43.8	2320
CX3-T103-U14	50	0.387	0.4938	0.2104	0.3715	234	181	225	46.8	2815
CX3-T103-U15	70	0.268	0.3422	0.2421	0.3482	286	223	281	51.1	3600
CX3-T103-U16	95	0.193	0.2468	0.2620	0.3366	343	268	341	53.9	4435
CX3-T103-U17	120	0.153	0.1960	0.2851	0.3252	390	307	394	57.1	5275
CX3-T103-U18	150	0.124	0.1594	0.3081	0.3156	438	346	448	60.3	6180
CX3-T103-U19	185	0.0991	0.1280	0.3360	0.3030	496	394	514	64.2	7415
CX3-T103-U20	240	0.0754	0.0984	0.3752	0.2917	575	461	608	69.8	9305
CX3-T103-U30	300	0.0601	0.0796	0.4177	0.2824	657	530	712	75.6	11230
CX3-T103-U40	400	0.047	0.0638	0.4600	0.2742	734	598	802	81.8	13970
CX3-T103-U50	500	0.0366	0.0518	0.5153	0.2655	829	682	924	89.5	17620
3 Core - AL/XLPE/PVC										
AX3-T103-U12	25	1.2	1.5386	0.1699	0.4238	129	99	122	41.2	1490
AX3-T103-U13	35	0.868	1.1130	0.1886	0.4014	153	118	145	43.8	1700
AX3-T103-U14	50	0.641	0.8220	0.2104	0.3715	181	140	174	46.8	1960
AX3-T103-U15	70	0.443	0.5683	0.2371	0.3514	222	173	218	50.4	2315
AX3-T103-U16	95	0.32	0.4107	0.2620	0.3366	266	208	265	53.9	2705
AX3-T103-U17	120	0.253	0.3249	0.2851	0.3252	303	238	306	57.1	3085
AX3-T103-U18	150	0.206	0.2649	0.3081	0.3156	340	269	348	60.3	3505
AX3-T103-U19	185	0.164	0.2113	0.3360	0.3030	386	307	401	64.2	4025
AX3-T103-U20	240	0.125	0.1617	0.3736	0.2921	449	360	474	69.6	4825
AX3-T103-U30	300	0.1	0.1300	0.4128	0.2829	509	411	547	74.9	5655
AX3-T103-U40	400	0.0778	0.1022	0.4568	0.2730	583	475	637	81.4	6840
AX3-T103-U50	500	0.0605	0.0808	0.5137	0.2668	673	554	757	89.8	8355

The above data is approximate and subjected to manufacturing tolerance

8.7/15 (17.5) KV Single Core ATA Cables

Single Core Cables, with stranded Circular copper or Aluminum conductors, XLPE insulated, aluminum tape armoured and PVC Sheath.

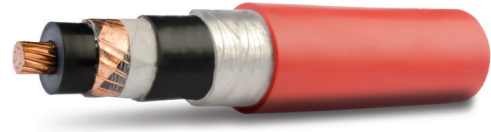

Description

- Stranded circular compacted copper or aluminum conductor, Semi-conducting layer as conductor screen, XLPE insulated, semi-conducting layer as non metallic insulation screen, copper tape or wire as metallic insulation screen, covered with a layer of PVC compound as bedding layer, aluminum tape armoured and PVC sheath.
- Cables are produced according to IEC 60502.

Application

- These cables are generally suitable for direct burial or for installation on trays or in ducts.

Product Code	Nominal Cross sectional area	Max. Conductor Resistance		Capacitance	Inductance		Current Rating					Approx. Overall Diameter	Approx. Weight
		DC at 20 °C	AC at 90 °C		Trefoil	Flat	Laid in ground			Laid in free air (Shaded)			
							Flat	Trefoil	Duct	Flat Touched	Trefoil Touched		
		mm ²	Ω/Km		Ω/Km	µf/km	mh/km	A	A	A	A		

1 Core - Cu/XLPE/ATA/PVC

CX3-T101-B12	25	0.727	0.9271	0.1699	0.4852	0.5314	168	168	136	165	167	23.8	810
CX3-T101-B13	35	0.524	0.6683	0.1886	0.4595	0.5057	201	201	164	199	203	24.9	930
CX3-T101-B14	50	0.387	0.4937	0.2104	0.4279	0.4741	238	237	197	239	242	26.4	1105
CX3-T101-B15	70	0.268	0.3421	0.2421	0.4001	0.4463	291	290	239	297	303	28.3	1360
CX3-T101-B16	95	0.193	0.2466	0.2620	0.3873	0.4335	349	346	286	359	367	29.7	1645
CX3-T101-B17	120	0.153	0.1958	0.2851	0.3732	0.4194	394	392	327	416	422	31.1	1920
CX3-T101-B18	150	0.124	0.1591	0.3081	0.3623	0.4085	443	438	379	471	479	32.7	2225
CX3-T101-B19	185	0.0991	0.1276	0.3360	0.3470	0.3933	501	493	419	540	547	34.4	2625
CX3-T101-B20	240	0.0754	0.0979	0.3752	0.3333	0.3796	581	568	486	637	643	37	3245
CX3-T101-B30	300	0.0601	0.0789	0.4177	0.3207	0.3670	654	630	554	731	734	39.6	3865
CX3-T101-B40	400	0.047	0.0629	0.4600	0.3116	0.3578	739	712	630	843	837	42.6	4765
CX3-T101-B50	500	0.0366	0.0506	0.5153	0.3013	0.3475	812	793	719	971	953	46.4	5980
CX3-T101-B60	630	0.0283	0.0411	0.5713	0.2923	0.3385	931	874	814	1111	1075	50.1	7375
CX3-T101-B70	800	0.0221	0.0344	0.6419	0.2839	0.3301	1026	947	907	1253	1194	55	9340

1 Core - AL/XLPE/ATA/PVC

AX3-T101-B12	25	1.2	1.5386	0.1699	0.4852	0.5314	131	130	106	127	130	23.8	660
AX3-T101-B13	35	0.868	1.1130	0.1886	0.4595	0.5057	157	155	127	154	157	24.9	725
AX3-T101-B14	50	0.641	0.8220	0.2104	0.4279	0.4741	185	184	151	185	189	26.4	820
AX3-T101-B15	70	0.443	0.5682	0.2371	0.4040	0.4502	227	225	190	230	236	28	935
AX3-T101-B16	95	0.32	0.4106	0.2620	0.3873	0.4335	270	271	221	279	286	29.7	1070
AX3-T101-B17	120	0.253	0.3248	0.2851	0.3732	0.4194	308	306	248	323	329	31.1	1190
AX3-T101-B18	150	0.206	0.2647	0.3081	0.3623	0.4085	343	341	286	366	373	32.7	1335
AX3-T101-B19	185	0.164	0.2110	0.3360	0.3470	0.3933	390	387	327	422	429	34.4	1495
AX3-T101-B20	240	0.125	0.1613	0.3736	0.3339	0.3801	457	447	381	497	505	36.9	1750
AX3-T101-B30	300	0.1	0.1296	0.4128	0.3216	0.3678	512	503	434	573	579	39.3	2010
AX3-T101-B40	400	0.0778	0.1016	0.4568	0.3106	0.3569	584	572	499	667	672	42.4	2390
AX3-T101-B50	500	0.0605	0.0801	0.5137	0.3025	0.3487	670	646	576	778	776	46.5	2890
AX3-T101-B60	630	0.0469	0.0635	0.5705	0.2930	0.3392	760	726	685	903	892	50.2	3460
AX3-T101-B70	800	0.0367	0.0514	0.6484	0.2830	0.3292	853	809	753	1042	1016	55.4	4240

The above data is approximate and subjected to manufacturing tolerance

8.7/15 (17.5) KV Multi Core STA Cables

Three Core Cables, with stranded circular copper or Aluminum conductors, XLPE insulated, Steel tape armoured and PVC Sheath.

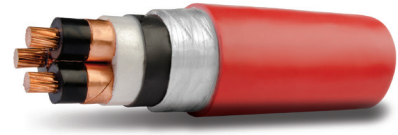

Description

- Stranded circular compacted copper or aluminum conductor, Semi-conducting layer as conductor screen, XLPE insulated, semi-conducting layer as non metallic insulation screen, copper tape or wire as metallic insulation screen, cores are assembled together with non hygroscopic polypropylene fillers and wrapped with binder tape, covered with a layer of PVC compound as bedding, steel tape armoured and PVC sheathed.
- Cables are produced according to IEC 60502.

Application

- These cables are generally suitable for direct burial or for installation on trays or in ducts.

Product Code	Nominal Cross sectional area	Max. Conductor Resistance		Capacitance	Inductance	Current Rating			Approx. Overall Diameter	Approx. Weight
		DC at 20 °C	AC at 90 °C			Ground	Duct	Laid in free air (Shaded)		
		mm ²	Ω/Km							
3 Core - Cu/XLPE/STA/PVC										
CX3-T103-G12	25	0.727	0.9271	0.1699	0.4238	158	126	150	45.8	2895
CX3-T103-G13	35	0.524	0.6684	0.1886	0.4014	189	151	182	48.4	3330
CX3-T103-G14	50	0.387	0.4938	0.2104	0.3715	223	179	217	51.6	3915
CX3-T103-G15	70	0.268	0.3422	0.2421	0.3482	274	221	271	55.7	4770
CX3-T103-G16	95	0.193	0.2468	0.2620	0.3366	325	263	325	58.7	5695
CX3-T103-G17	120	0.153	0.1960	0.2851	0.3252	368	300	372	62.1	6645
CX3-T103-G18	150	0.124	0.1594	0.3081	0.3156	412	337	421	65.3	7620
CX3-T103-G19	185	0.0991	0.1280	0.3360	0.3030	464	381	479	69.2	8945
CX3-T103-G20	240	0.0754	0.0984	0.3752	0.2917	534	442	559	75	11005
CX3-T103-G30	300	0.0601	0.0796	0.4177	0.2824	602	502	640	82.4	13910
CX3-T103-G40	400	0.047	0.0638	0.4600	0.2742	676	568	729	88.4	16820
CX3-T103-G50	500	0.0366	0.0518	0.5153	0.2655	755	639	827	96.3	20775
3 Core - AL/XLPE/STA/PVC										
AX3-T103-G12	25	1.2	1.5386	0.1699	0.4238	122	98	117	45.8	2445
AX3-T103-G13	35	0.868	1.1130	0.1886	0.4014	146	117	141	48.4	2710
AX3-T103-G14	50	0.641	0.8220	0.2104	0.3715	173	139	168	51.6	3060
AX3-T103-G15	70	0.443	0.5683	0.2371	0.3514	212	171	209	55	3470
AX3-T103-G16	95	0.32	0.4107	0.2620	0.3366	253	205	253	58.7	3965
AX3-T103-G17	120	0.253	0.3249	0.2851	0.3252	287	234	290	62.1	4455
AX3-T103-G18	150	0.206	0.2649	0.3081	0.3156	322	263	328	65.3	4945
AX3-T103-G19	185	0.164	0.2113	0.3360	0.3030	364	299	375	69.2	5555
AX3-T103-G20	240	0.125	0.1617	0.3736	0.2921	421	348	440	74.8	6520
AX3-T103-G30	300	0.1	0.1300	0.4128	0.2829	476	397	504	81.7	8310
AX3-T103-G40	400	0.0778	0.1022	0.4568	0.2730	542	455	582	88	9675
AX3-T103-G50	500	0.0605	0.0808	0.5137	0.2668	615	521	673	96.6	11525

The above data is approximate and subjected to manufacturing tolerance

8.7/15 (17.5) KV Single Core AWA Cables

Single Core Cables, with stranded Circular copper or Aluminum conductors, XLPE insulated, aluminum wire armoured and PVC Sheath.

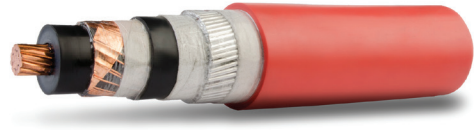

Description

- Stranded circular compacted copper or aluminum conductor, Semi-conducting layer as conductor screen, XLPE insulated, semi-conducting layer as non metallic insulation screen, copper tape or wire as metallic insulation screen, covered with a layer of PVC compound as bedding layer, aluminum wire armoured and PVC sheath.
- Cables are produced according to IEC 60502 or BS 6622.

Application

- These cables are generally suitable for direct burial or for installation on trays or in ducts.

Product Code	Nominal Cross sectional area	Max. Conductor Resistance		Capacitance	Inductance		Current Rating					Approx. Overall Diameter	Approx. Weight
		DC at 20 °C	AC at 90 °C		Laid in ground			Laid in free air (Shaded)					
					Trefoil	Flat	Flat Trefoil Duct	Flat Trefoil	Trefoil				
		mm ²	Ω/Km		Ω/Km	µf/km	mh/km	Flat	Trefoil	Duct	Flat Touched		
1 Core - Cu/XLPE/AWA/PVC													
CX3-T101-X12	25	0.727	0.9271	0.1699	0.5006	0.5468	169	168	137	166	169	25.7	935
CX3-T101-X13	35	0.524	0.6683	0.1886	0.4757	0.5219	201	201	165	202	205	27	1075
CX3-T101-X14	50	0.387	0.4937	0.2104	0.4418	0.4880	238	237	195	242	245	28.3	1245
CX3-T101-X15	70	0.268	0.3421	0.2421	0.4144	0.4606	290	289	239	300	303	30.4	1525
CX3-T101-X16	95	0.193	0.2466	0.2620	0.4028	0.4491	346	343	286	364	365	32.1	1850
CX3-T101-X17	120	0.153	0.1958	0.2851	0.3892	0.4354	391	386	325	417	416	33.7	2150
CX3-T101-X18	150	0.124	0.1590	0.3081	0.3764	0.4227	436	430	365	471	468	35.1	2450
CX3-T101-X19	185	0.0991	0.1275	0.3360	0.3616	0.4078	489	479	411	536	527	37	2880
CX3-T101-X20	240	0.0754	0.0978	0.3752	0.3459	0.3921	561	542	475	628	609	39.4	3495
CX3-T101-X30	300	0.0601	0.0788	0.4177	0.3325	0.3787	627	596	534	714	684	42	4125
CX3-T101-X40	400	0.047	0.0627	0.4600	0.3278	0.3740	689	636	595	805	749	46.2	5220
CX3-T101-X50	500	0.0366	0.0503	0.5153	0.3163	0.3625	763	689	665	913	835	50	6465
CX3-T101-X60	630	0.0283	0.0407	0.5713	0.3061	0.3524	837	742	736	1023	916	53.7	7900
CX3-T101-X70	800	0.0221	0.0340	0.6419	0.2959	0.3421	907	787	806	1136	996	58.4	9895
1 Core - AL/XLPE/AWA/PVC													
AX3-T101-X12	25	1.2	1.5386	0.1699	0.5006	0.5468	131	131	107	129	132	25.7	785
AX3-T101-X13	35	0.868	1.1130	0.1886	0.4757	0.5219	156	156	128	157	160	27	870
AX3-T101-X14	50	0.641	0.8220	0.2104	0.4418	0.4880	185	185	152	188	191	28.3	960
AX3-T101-X15	70	0.443	0.5682	0.2371	0.4185	0.4647	226	226	187	234	238	30.1	1100
AX3-T101-X16	95	0.32	0.4106	0.2620	0.4028	0.4491	270	269	224	284	287	32.1	1275
AX3-T101-X17	120	0.253	0.3248	0.2851	0.3892	0.4354	307	304	255	326	329	33.7	1420
AX3-T101-X18	150	0.206	0.2646	0.3081	0.3764	0.4227	342	339	286	369	371	35.1	1555
AX3-T101-X19	185	0.164	0.2110	0.3360	0.3616	0.4078	385	382	325	422	422	37	1750
AX3-T101-X20	240	0.125	0.1613	0.3736	0.3465	0.3927	445	438	377	496	491	39.3	2005
AX3-T101-X30	300	0.1	0.1295	0.4128	0.3334	0.3797	501	489	426	568	558	41.7	2265
AX3-T101-X40	400	0.0778	0.1015	0.4568	0.3269	0.3731	561	536	484	653	628	46	2845
AX3-T101-X50	500	0.0605	0.0799	0.5137	0.3174	0.3636	632	593	551	752	712	50.1	3375
AX3-T101-X60	630	0.0469	0.0632	0.5705	0.3068	0.3531	707	651	621	858	798	53.8	3985
AX3-T101-X70	800	0.0367	0.0511	0.6484	0.2949	0.3412	782	707	696	976	890	58.8	4795

The above data is approximate and subjected to manufacturing tolerance

8.7/15 (17.5) KV Multi Core SWA Cables

Three Core Cables, with stranded circular copper or Aluminum conductors, XLPE insulated, Steel wire armoured and PVC Sheath.



Description

- Stranded circular compacted copper or aluminum conductor, Semi-conducting layer as conductor screen, XLPE insulated, semi-conducting layer as non metallic insulation screen, copper tape or wire as metallic insulation screen, cores are assembled together with non hygroscopic polypropylene fillers and wrapped with binder tape, covered with a layer of PVC compound as bedding, steel wire armoured and PVC sheathed.
- Cables are produced according to IEC 60502 or BS 6622.

Application

- These cables are generally suitable for direct burial or for installation on trays or in ducts.

Product Code	Nominal Cross sectional area	Max. Conductor Resistance		Capacitance	Inductance	Current Rating			Approx. Overall Diameter	Approx. Weight
		DC at 20 °C	AC at 90 °C			Ground	Duct	Laid in free air (Shaded)		
		mm ²	Ω/Km							
3 Core - Cu/XLPE/SWA/PVC										
CX3-T103-W12	25	0.727	0.9271	0.1699	0.4238	159	127	153	49	4260
CX3-T103-W13	35	0.524	0.6684	0.1886	0.4014	190	153	185	51.6	4780
CX3-T103-W14	50	0.387	0.4938	0.2104	0.3715	224	182	220	54.6	5425
CX3-T103-W15	70	0.268	0.3422	0.2421	0.3482	275	223	275	58.9	6445
CX3-T103-W16	95	0.193	0.2468	0.2620	0.3366	327	266	329	61.9	7455
CX3-T103-W17	120	0.153	0.1960	0.2851	0.3252	370	303	376	65.3	8485
CX3-T103-W18	150	0.124	0.1594	0.3081	0.3156	415	342	428	70.2	10310
CX3-T103-W19	185	0.0991	0.1280	0.3360	0.3030	464	385	484	74.5	11910
CX3-T103-W20	240	0.0754	0.0984	0.3752	0.2917	533	445	564	80.1	14180
CX3-T103-W30	300	0.0601	0.0796	0.4177	0.2824	594	498	638	86.1	16525
CX3-T103-W40	400	0.047	0.0638	0.4600	0.2742	663	559	721	92.3	19660
CX3-T103-W50	500	0.0366	0.0518	0.5153	0.2655	734	625	812	100.2	23890
3 Core - AL/XLPE/SWA/PVC										
AX3-T103-W12	25	1.2	1.5386	0.1699	0.4238	123	99	118	49	3810
AX3-T103-W13	35	0.868	1.1130	0.1886	0.4014	147	119	143	51.6	4165
AX3-T103-W14	50	0.641	0.8220	0.2104	0.3715	174	141	171	54.6	4570
AX3-T103-W15	70	0.443	0.5683	0.2371	0.3514	213	173	212	58.2	5120
AX3-T103-W16	95	0.32	0.4107	0.2620	0.3366	254	207	256	61.9	5730
AX3-T103-W17	120	0.253	0.3249	0.2851	0.3252	289	236	293	65.3	6295
AX3-T103-W18	150	0.206	0.2649	0.3081	0.3156	324	267	334	70.2	7635
AX3-T103-W19	185	0.164	0.2113	0.3360	0.3030	365	303	380	74.5	8520
AX3-T103-W20	240	0.125	0.1617	0.3736	0.2921	421	350	445	79.9	9695
AX3-T103-W30	300	0.1	0.1300	0.4128	0.2829	473	397	506	85.4	10880
AX3-T103-W40	400	0.0778	0.1022	0.4568	0.2730	536	452	580	91.9	12525
AX3-T103-W50	500	0.0605	0.0808	0.5137	0.2668	604	516	666	100.5	14630

The above data is approximate and subjected to manufacturing tolerance

12/20 (24) KV Single Core Unarmoured Cables

Single Core Cables, with stranded Circular copper or Aluminum conductors, XLPE insulated, and PVC Sheath.



Description

- Stranded circular compacted copper or aluminum conductor, Semi-conducting layer as conductor screen, XLPE insulated, semi-conducting layer as non metallic insulation screen, copper tape or wire as metallic insulation screen, and PVC sheathed.
- Cables are produced according to IEC 60502.

Application

- These cables are generally suitable for direct burial or for installation on trays or in ducts.

Product Code	Nominal Cross sectional area	Max. Conductor Resistance		Capacitance	Inductance		Current Rating					Approx. Overall Diameter	Approx. Weight
		DC at 20 °C	AC at 90 °C		Trefoil	Flat	Laid in ground			Laid in free air (Shaded)			
							Flat	Trefoil	Duct	Flat Touched	Trefoil Touched		
		mm ²	Ω/Km		Ω/Km	µf/km	mh/km	A	A	A	A		
1 Core - Cu/XLPE/PVC													
CX4-T101-U13	35	0.524	0.6683	0.1632	0.4428	0.4890	201	207	152	189	193	22.9	765
CX4-T101-U14	50	0.387	0.4937	0.1812	0.4121	0.4583	238	245	183	227	234	24.4	930
CX4-T101-U15	70	0.268	0.3421	0.2072	0.3854	0.4317	292	297	227	287	295	26.3	1170
CX4-T101-U16	95	0.193	0.2467	0.2235	0.3734	0.4196	347	353	275	347	360	27.7	1445
CX4-T101-U17	120	0.153	0.1959	0.2424	0.3599	0.4061	397	402	318	403	416	29.1	1710
CX4-T101-U18	150	0.124	0.1591	0.2612	0.3496	0.3959	443	448	358	460	468	30.7	2005
CX4-T101-U19	185	0.0991	0.1277	0.2839	0.3351	0.3813	501	505	416	523	540	32.4	2390
CX4-T101-U20	240	0.0754	0.0980	0.3159	0.3222	0.3684	580	579	481	630	638	35	2990
CX4-T101-U30	300	0.0601	0.0790	0.3505	0.3114	0.3577	662	650	550	725	736	37.8	3605
CX4-T101-U40	400	0.047	0.0631	0.3850	0.3020	0.3482	750	729	625	832	841	40.6	4470
CX4-T101-U50	500	0.0366	0.0508	0.4300	0.2916	0.3378	844	819	711	962	971	44.2	5635
CX4-T101-U60	630	0.0283	0.0414	0.4755	0.2833	0.3295	945	906	807	1104	1099	47.9	7000
CX4-T101-U70	800	0.0221	0.0347	0.5329	0.2750	0.3212	1035	988	904	1249	1238	52.6	8895
1 Core - AL/XLPE/PVC													
AX4-T101-U13	35	0.868	1.1130	0.1632	0.4428	0.4890	158	160	123	149	153	22.9	560
AX4-T101-U14	50	0.641	0.8220	0.1812	0.4121	0.4583	188	189	148	185	188	24.4	645
AX4-T101-U15	70	0.443	0.5682	0.2031	0.3892	0.4354	228	232	181	229	235	26	745
AX4-T101-U16	95	0.32	0.4106	0.2235	0.3734	0.4196	275	278	222	277	284	27.7	870
AX4-T101-U17	120	0.253	0.3248	0.2424	0.3599	0.4061	312	320	254	320	328	29.1	980
AX4-T101-U18	150	0.206	0.2647	0.2612	0.3496	0.3959	350	354	286	363	372	30.7	1110
AX4-T101-U19	185	0.164	0.2111	0.2839	0.3351	0.3813	396	405	322	417	428	32.4	1260
AX4-T101-U20	240	0.125	0.1614	0.3146	0.3227	0.3690	460	465	381	495	509	34.9	1495
AX4-T101-U30	300	0.1	0.1297	0.3465	0.3122	0.3584	517	520	435	570	586	37.5	1755
AX4-T101-U40	400	0.0778	0.1017	0.3823	0.3010	0.3472	591	600	505	665	680	40.4	2095
AX4-T101-U50	500	0.0605	0.0802	0.4286	0.2928	0.3390	675	675	580	779	798	44.3	2540
AX4-T101-U60	630	0.0469	0.0637	0.4749	0.2840	0.3303	768	790	675	905	920	48	3080
AX4-T101-U70	800	0.0367	0.0517	0.5382	0.2742	0.3204	863	894	766	1049	1060	53	3800

The above data is approximate and subjected to manufacturing tolerance
this data is applicable also for 12.7/22 KV

12/20 (24) KV Multi Core Unarmoured Cables

Three Core Cables, with stranded circular copper or Aluminum conductors, XLPE insulated, and PVC Sheath.



Description

- Stranded circular compacted copper or aluminum conductor, Semi-conducting layer as conductor screen, XLPE insulated, semi-conducting layer as non metallic insulation screen, copper tape or wire as metallic insulation screen, cores are assembled together with non hygroscopic polypropylene fillers and wrapped with binder tape, and PVC sheathed.
- Cables are produced according to IEC 60502.

Application

- These cables are generally suitable for direct burial or for installation on trays or in ducts.

Product Code	Nominal Cross sectional area	Max. Conductor Resistance		Capacitance	Inductance	Current Rating			Approx. Overall Diameter	Approx. Weight
		DC at 20 °C	AC at 90 °C			Ground	Duct	Laid in free air (Shaded)		
		Ω/Km	Ω/Km							
mm ²	Ω/Km	Ω/Km	μf/km	mh/km	A	A	A	mm	Kg/Km	
3 Core - Cu/XLPE/PVC										
CX4-T103-U13	35	0.524	0.6683	0.1632	0.4230	200	156	194	48.3	2620
CX4-T103-U14	50	0.387	0.4937	0.1812	0.3917	234	184	229	51.3	3130
CX4-T103-U15	70	0.268	0.3422	0.2072	0.3667	287	226	285	55.6	3940
CX4-T103-U16	95	0.193	0.2467	0.2235	0.3541	343	272	346	58.4	4795
CX4-T103-U17	120	0.153	0.1960	0.2424	0.3417	391	311	398	61.6	5655
CX4-T103-U18	150	0.124	0.1592	0.2612	0.3312	439	351	453	64.8	6580
CX4-T103-U19	185	0.0991	0.1279	0.2839	0.3177	496	399	518	68.9	7870
CX4-T103-U20	240	0.0754	0.0982	0.3159	0.3052	576	466	613	74.3	9760
CX4-T103-U30	300	0.0601	0.0794	0.3505	0.2948	657	536	716	80.3	11755
CX4-T103-U40	400	0.047	0.0636	0.3850	0.2857	736	605	808	86.3	14500
CX4-T103-U50	500	0.0366	0.0514	0.4300	0.2760	832	690	931	94.1	18200
3 Core - AL/XLPE/PVC										
AX4-T103-U13	35	0.868	1.1130	0.1632	0.4230	155	121	151	48.3	2000
AX4-T103-U14	50	0.641	0.8220	0.1812	0.3917	181	142	177	51.3	2275
AX4-T103-U15	70	0.443	0.5682	0.2031	0.3702	223	176	221	54.9	2655
AX4-T103-U16	95	0.32	0.4107	0.2235	0.3541	266	211	268	58.4	3065
AX4-T103-U17	120	0.253	0.3249	0.2424	0.3417	304	242	310	61.6	3465
AX4-T103-U18	150	0.206	0.2648	0.2612	0.3312	341	272	351	64.8	3905
AX4-T103-U19	185	0.164	0.2112	0.2839	0.3177	386	311	404	68.9	4480
AX4-T103-U20	240	0.125	0.1615	0.3146	0.3057	450	364	478	74.1	5280
AX4-T103-U30	300	0.1	0.1299	0.3465	0.2954	509	415	550	79.7	6185
AX4-T103-U40	400	0.0778	0.1020	0.3823	0.2846	584	479	641	85.9	7365
AX4-T103-U50	500	0.0605	0.0806	0.4286	0.2773	674	558	760	94.3	8930

The above data is approximate and subjected to manufacturing tolerance
this data is applicable also for 12.7/22 KV

12/20 (24) KV Single Core ATA Cables

Single Core Cables, with stranded Circular copper or Aluminum conductors, XLPE insulated, aluminum tape armoured and PVC Sheath.



Description

- Stranded circular compacted copper or aluminum conductor, Semi-conducting layer as conductor screen, XLPE insulated, semi-conducting layer as non metallic insulation screen, copper tape or wire as metallic insulation screen, covered with a layer of PVC compound as bedding layer, aluminum tape armoured and PVC sheath.
- Cables are produced according to IEC 60502.

Application

- These cables are generally suitable for direct burial or for installation on trays or in ducts.

Product Code	Nominal Cross sectional area	Max. Conductor Resistance		Capacitance	Inductance		Current Rating					Approx. Overall Diameter	Approx. Weight
		DC at 20 °C	AC at 90 °C		Trefoil	Flat	Laid in ground			Laid in free air (Shaded)			
							Flat	Trefoil	Duct	Flat Touched	Trefoil Touched		
		mm ²	Ω/Km		Ω/Km	µf/km	mh/km	A	A	A	A		
1 Core - Cu/XLPE/ATA/PVC													
CX4-T101-B13	35	0.524	0.6683	0.1632	0.4764	0.5227	201	202	165	201	205	27.1	1040
CX4-T101-B14	50	0.387	0.4937	0.1812	0.4425	0.4887	238	236	199	241	244	28.4	1205
CX4-T101-B15	70	0.268	0.3421	0.2072	0.4151	0.4613	290	289	241	299	305	30.5	1485
CX4-T101-B16	95	0.193	0.2466	0.2235	0.4003	0.4466	348	345	289	361	369	31.7	1760
CX4-T101-B17	120	0.153	0.1958	0.2424	0.3868	0.4330	394	391	330	418	424	33.3	2050
CX4-T101-B18	150	0.124	0.1590	0.2612	0.3741	0.4204	443	437	383	474	481	34.7	2345
CX4-T101-B19	185	0.0991	0.1275	0.2839	0.3594	0.4057	500	492	422	543	549	36.6	2770
CX4-T101-B20	240	0.0754	0.0978	0.3159	0.3439	0.3901	580	567	492	639	646	39	3375
CX4-T101-B30	300	0.0601	0.0788	0.3505	0.3325	0.3787	653	633	559	731	735	42	4045
CX4-T101-B40	400	0.047	0.0628	0.3850	0.3216	0.3679	738	711	635	844	838	44.8	4940
CX4-T101-B50	500	0.0366	0.0504	0.4300	0.3106	0.3568	832	792	723	973	954	48.6	6165
CX4-T101-B60	630	0.0283	0.0409	0.4755	0.3016	0.3478	930	872	808	1112	1075	52.5	7600
CX4-T101-B70	800	0.0221	0.0342	0.5329	0.2910	0.3373	1027	947	914	1256	1196	57	9525
1 Core - AL/XLPE/ATA/PVC													
AX4-T101-B13	35	0.868	1.1130	0.1632	0.4764	0.5227	156	155	128	155	159	27.1	835
AX4-T101-B14	50	0.641	0.8220	0.1812	0.4425	0.4887	184	184	153	187	191	28.4	920
AX4-T101-B15	70	0.443	0.5682	0.2031	0.4191	0.4653	226	224	192	231	238	30.2	1055
AX4-T101-B16	95	0.32	0.4106	0.2235	0.4003	0.4466	269	271	223	281	288	31.7	1180
AX4-T101-B17	120	0.253	0.3248	0.2424	0.3868	0.4330	308	305	250	325	331	33.3	1320
AX4-T101-B18	150	0.206	0.2646	0.2612	0.3741	0.4204	343	341	289	368	374	34.7	1455
AX4-T101-B19	185	0.164	0.2110	0.2839	0.3594	0.4057	389	386	329	424	430	36.6	1640
AX4-T101-B20	240	0.125	0.1613	0.3146	0.3444	0.3907	451	446	386	499	507	38.9	1885
AX4-T101-B30	300	0.1	0.1295	0.3465	0.3334	0.3797	511	502	437	574	578	41.7	2190
AX4-T101-B40	400	0.0778	0.1015	0.3823	0.3207	0.3670	583	571	502	669	673	44.6	2565
AX4-T101-B50	500	0.0605	0.0799	0.4286	0.3117	0.3580	669	645	578	779	776	48.7	3075
AX4-T101-B60	630	0.0469	0.0633	0.4749	0.3023	0.3486	759	724	690	903	891	52.6	3680
AX4-T101-B70	800	0.0367	0.0512	0.5382	0.2901	0.3363	853	809	760	1042	1016	57.4	4430

The above data is approximate and subjected to manufacturing tolerance
this data is applicable also for 12.7/22 KV

12/20 (24) KV Multi Core STA Cables

Three Core Cables, with stranded circular copper or Aluminum conductors, XLPE insulated, Steel tape armoured and PVC Sheath.

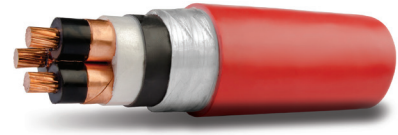

Description

- Stranded circular compacted copper or aluminum conductor, Semi-conducting layer as conductor screen, XLPE insulated, semi-conducting layer as non metallic insulation screen, copper tape or wire as metallic insulation screen, cores are assembled together with non hygroscopic polypropylene fillers and wrapped with binder tape, covered with a layer of PVC compound as bedding, steel tape armoured and PVC sheathed.
- Cables are produced according to IEC 60502.

Application

- These cables are generally suitable for direct burial or for installation on trays or in ducts.

Product Code	Nominal Cross sectional area	Max. Conductor Resistance		Capacitance	Inductance	Current Rating			Approx. Overall Diameter	Approx. Weight
		DC at 20 °C	AC at 90 °C			Ground	Duct	Laid in free air (Shaded)		
		mm ²	Ω/Km							
3 Core - Cu/XLPE/STA/PVC										
CX4-T103-G13	35	0.524	0.6683	0.1632	0.4230	189	153	184	53.1	3755
CX4-T103-G14	50	0.387	0.4937	0.1812	0.3917	223	181	220	56.1	4335
CX4-T103-G15	70	0.268	0.3422	0.2072	0.3667	274	224	274	60.4	5245
CX4-T103-G16	95	0.193	0.2467	0.2235	0.3541	325	267	328	63.4	6190
CX4-T103-G17	120	0.153	0.1960	0.2424	0.3417	368	303	374	66.8	7165
CX4-T103-G18	150	0.124	0.1592	0.2612	0.3312	413	340	424	69.8	8125
CX4-T103-G19	185	0.0991	0.1279	0.2839	0.3177	464	385	481	74.1	9545
CX4-T103-G20	240	0.0754	0.0982	0.3159	0.3052	537	449	565	81.1	12400
CX4-T103-G30	300	0.0601	0.0794	0.3505	0.2948	602	508	643	86.9	14560
CX4-T103-G40	400	0.047	0.0636	0.3850	0.2857	676	571	730	93.3	17590
CX4-T103-G50	500	0.0366	0.0514	0.4300	0.2760	756	646	831	101.1	21570
3 Core - AL/XLPE/STA/PVC										
AX4-T103-G13	35	0.868	1.1130	0.1632	0.4230	146	118	143	53.1	3140
AX4-T103-G14	50	0.641	0.8220	0.1812	0.3917	173	141	171	56.1	3480
AX4-T103-G15	70	0.443	0.5682	0.2031	0.3702	212	173	212	59.7	3940
AX4-T103-G16	95	0.32	0.4107	0.2235	0.3541	253	208	255	63.4	4465
AX4-T103-G17	120	0.253	0.3249	0.2424	0.3417	287	237	292	66.8	4975
AX4-T103-G18	150	0.206	0.2648	0.2612	0.3312	322	265	330	69.8	5450
AX4-T103-G19	185	0.164	0.2112	0.2839	0.3177	364	302	377	74.1	6155
AX4-T103-G20	240	0.125	0.1615	0.3146	0.3057	422	353	444	80.9	7905
AX4-T103-G30	300	0.1	0.1299	0.3465	0.2954	476	400	507	86.3	8965
AX4-T103-G40	400	0.0778	0.1020	0.3823	0.2846	541	458	583	92.9	10445
AX4-T103-G50	500	0.0605	0.0806	0.4286	0.2773	615	525	674	101.3	12305

The above data is approximate and subjected to manufacturing tolerance
this data is applicable also for 12.7/22 KV

12/20 (24) KV Single Core AWA Cables

Single Core Cables, with stranded Circular copper or Aluminum conductors, XLPE insulated, aluminum wire armoured and PVC Sheath.



Description

- Stranded circular compacted copper or aluminum conductor, Semi-conducting layer as conductor screen, XLPE insulated, semi-conducting layer as non metallic insulation screen, copper tape or wire as metallic insulation screen, covered with a layer of PVC compound as bedding layer, aluminum wire armoured and PVC sheath,
- Cables are produced according to IEC 60502 or BS 6622.

Application

- These cables are generally suitable for direct burial or for installation on trays or in ducts.

Product Code	Nominal Cross sectional area	Max. Conductor Resistance		Capacitance	Inductance		Current Rating					Approx. Overall Diameter	Approx. Weight
		DC at 20 °C	AC at 90 °C		Laid in ground			Laid in free air (Shaded)					
					Trefoil	Flat	Flat Trefoil Duct	Flat Trefoil Touched	Trefoil Touched				
		mm ²	Ω/Km		Ω/Km	µf/km	mh/km	Flat Trefoil Duct	Flat Trefoil Touched	Trefoil Touched	A		
1 Core - Cu/XLPE/AWA/PVC													
CX4-T101-X13	35	0.524	0.6683	0.1632	0.4900	0.5362	201	201	166	203	207	29	1185
CX4-T101-X14	50	0.387	0.4937	0.1812	0.4567	0.5030	238	237	197	244	247	30.5	1365
CX4-T101-X15	70	0.268	0.3421	0.2072	0.4314	0.4777	290	288	242	303	306	33.1	1705
CX4-T101-X16	95	0.193	0.2466	0.2235	0.4161	0.4623	345	342	289	366	366	34.3	1990
CX4-T101-X17	120	0.153	0.1957	0.2424	0.4019	0.4481	390	385	328	419	418	35.9	2295
CX4-T101-X18	150	0.124	0.1590	0.2612	0.3886	0.4348	435	429	368	473	468	37.3	2600
CX4-T101-X19	185	0.0991	0.1275	0.2839	0.3721	0.4184	488	478	414	539	530	39	3015
CX4-T101-X20	240	0.0754	0.0977	0.3159	0.3558	0.4020	560	541	479	630	611	41.4	3635
CX4-T101-X30	300	0.0601	0.0786	0.3505	0.3490	0.3952	617	582	534	712	675	45.6	4485
CX4-T101-X40	400	0.047	0.0625	0.3850	0.3371	0.3833	689	636	599	808	753	48.4	5410
CX4-T101-X50	500	0.0366	0.0501	0.4300	0.3249	0.3711	763	689	669	914	834	52.2	6685
CX4-T101-X60	630	0.0283	0.0406	0.4755	0.3142	0.3604	838	742	741	1026	921	55.9	8130
CX4-T101-X70	800	0.0221	0.0338	0.5329	0.3033	0.3495	909	789	812	1140	1002	60.6	10125
1 Core - AL/XLPE/AWA/PVC													
AX4-T101-X13	35	0.868	1.1130	0.1632	0.4900	0.5362	156	156	129	158	161	29	975
AX4-T101-X14	50	0.641	0.8220	0.1812	0.4567	0.5030	185	184	154	189	193	30.5	1080
AX4-T101-X15	70	0.443	0.5682	0.2031	0.4356	0.4819	226	225	189	236	240	32.8	1280
AX4-T101-X16	95	0.32	0.4106	0.2235	0.4161	0.4623	269	268	226	285	288	34.3	1415
AX4-T101-X17	120	0.253	0.3248	0.2424	0.4019	0.4481	305	303	257	328	330	35.9	1565
AX4-T101-X18	150	0.206	0.2646	0.2612	0.3886	0.4348	341	339	327	370	372	37.3	1710
AX4-T101-X19	185	0.164	0.2109	0.2839	0.3721	0.4184	385	381	380	424	424	39	1885
AX4-T101-X20	240	0.125	0.1612	0.3146	0.3564	0.4026	444	438	380	498	493	41.3	2145
AX4-T101-X30	300	0.1	0.1294	0.3465	0.3500	0.3962	495	480	428	568	553	45.3	2630
AX4-T101-X40	400	0.0778	0.1014	0.3823	0.3363	0.3825	560	535	487	654	630	48.2	3035
AX4-T101-X50	500	0.0605	0.0798	0.4286	0.3260	0.3722	631	592	553	752	711	52.3	3595
AX4-T101-X60	630	0.0469	0.0631	0.4749	0.3149	0.3611	706	650	625	859	800	56	4210
AX4-T101-X70	800	0.0367	0.0509	0.5382	0.3023	0.3485	782	707	700	977	893	61	5030

The above data is approximate and subjected to manufacturing tolerance
this data is applicable also for 12.7/22 KV

12/20 (24) KV Multi Core SWA Cables

Three Core Cables, with stranded circular copper or Aluminum conductors, XLPE insulated, Steel wire armoured and PVC Sheath.



Description

- Stranded circular compacted copper or aluminum conductor, Semi-conducting layer as conductor screen, XLPE insulated, semi-conducting layer as non metallic insulation screen, copper tape or wire as metallic insulation screen, cores are assembled together with non hygroscopic polypropylene fillers and wrapped with binder tape, covered with a layer of PVC compound as bedding, steel wire armoured and PVC sheathed.
- Cables are produced according to IEC 60502 or BS 6622.

Application

- These cables are generally suitable for direct burial or for installation on trays or in ducts.

Product Code	Nominal Cross sectional area	Max. Conductor Resistance		Capacitance	Inductance	Current Rating			Approx. Overall Diameter	Approx. Weight
		DC at 20 °C	AC at 90 °C			Ground	Duct	Laid in free air (Shaded)		
		mm ²	Ω/Km							
3 Core - Cu/XLPE/SWA/PVC										
CX4-T103-W13	35	0.524	0.6683	0.1632	0.4230	190	155	186	56.3	5345
CX4-T103-W14	50	0.387	0.4937	0.1812	0.3917	225	183	223	59.3	6010
CX4-T103-W15	70	0.268	0.3422	0.2072	0.3667	275	226	277	63.6	7060
CX4-T103-W16	95	0.193	0.2467	0.2235	0.3541	326	268	331	66.6	8090
CX4-T103-W17	120	0.153	0.1960	0.2424	0.3417	370	307	380	71.9	9995
CX4-T103-W18	150	0.124	0.1592	0.2612	0.3312	413	344	429	75.1	11080
CX4-T103-W19	185	0.0991	0.1279	0.2839	0.3177	464	387	486	79.2	12670
CX4-T103-W20	240	0.0754	0.0982	0.3159	0.3052	532	447	565	84.8	14980
CX4-T103-W30	300	0.0601	0.0794	0.3505	0.2948	593	502	639	90.8	17360
CX4-T103-W40	400	0.047	0.0636	0.3850	0.2857	661	563	721	97.2	20585
CX4-T103-W50	500	0.0366	0.0514	0.4300	0.2760	734	628	814	105	24830
3 Core - AL/XLPE/SWA/PVC										
AX4-T103-W13	35	0.868	1.1130	0.1632	0.4230	147	120	144	56.3	4730
AX4-T103-W14	50	0.641	0.8220	0.1812	0.3917	174	142	173	59.3	5155
AX4-T103-W15	70	0.443	0.5682	0.2031	0.3702	213	175	214	62.9	5730
AX4-T103-W16	95	0.32	0.4107	0.2235	0.3541	254	209	258	66.6	6365
AX4-T103-W17	120	0.253	0.3249	0.2424	0.3417	289	240	297	71.9	7805
AX4-T103-W18	150	0.206	0.2648	0.2612	0.3312	323	269	335	75.1	8405
AX4-T103-W19	185	0.164	0.2112	0.2839	0.3177	365	304	381	79.2	9280
AX4-T103-W20	240	0.125	0.1615	0.3146	0.3057	421	354	446	84.6	10495
AX4-T103-W30	300	0.1	0.1299	0.3465	0.2954	473	400	507	90.2	11720
AX4-T103-W40	400	0.0778	0.1020	0.3823	0.2846	534	455	581	96.8	13445
AX4-T103-W50	500	0.0605	0.0806	0.4286	0.2773	604	517	667	105.2	15560

The above data is approximate and subjected to manufacturing tolerance
this data is applicable also for 12.7/22 KV

18/30 (36) KV Single Core Unarmoured Cables

Single Core Cables, with stranded Circular copper or Aluminum conductors, XLPE insulated, and PVC Sheath.

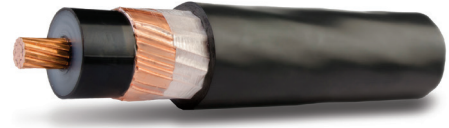

Description

- Stranded circular compacted copper or aluminum conductor, Semi-conducting layer as conductor screen, XLPE insulated, semi-conducting layer as non metallic insulation screen, copper tape or wire as metallic insulation screen, and PVC sheathed.
- Cables are produced according to IEC 60502.

Application

- These cables are generally suitable for direct burial or for installation on trays or in ducts.

Product Code	Nominal Cross sectional area	Max. Conductor Resistance		Capacitance	Inductance		Current Rating					Approx. Overall Diameter	Approx. Weight
		DC at 20 °C	AC at 90 °C		Trefoil	Flat	Laid in ground			Laid in free air (Shaded)			
							Flat	Trefoil	Duct	Flat Touched	Trefoil Touched		
		mm ²	Ω/Km		Ω/Km	µf/km	mh/km		A	A	A		
1 Core - Cu/XLPE/PVC													
CX5-T101-U14	50	0.387	0.4937	0.1412	0.4508	0.4970	238	245	183	227	238	29.6	1175
CX5-T101-U15	70	0.268	0.3421	0.1596	0.4215	0.4677	292	297	230	290	295	31.5	1430
CX5-T101-U16	95	0.193	0.2466	0.1711	0.4078	0.4540	347	356	279	351	364	32.9	1715
CX5-T101-U17	120	0.153	0.1958	0.1844	0.3927	0.4390	397	404	322	407	420	34.3	1990
CX5-T101-U18	150	0.124	0.1590	0.1976	0.3809	0.4272	447	451	362	464	471	35.9	2300
CX5-T101-U19	185	0.0991	0.1275	0.2135	0.3648	0.4111	505	509	420	527	544	37.6	2700
CX5-T101-U20	240	0.0754	0.0977	0.2358	0.3499	0.3961	585	583	485	633	641	40.2	3320
CX5-T101-U30	300	0.0601	0.0787	0.2599	0.3372	0.3834	666	654	554	729	740	43	3960
CX5-T101-U40	400	0.047	0.0627	0.2839	0.3261	0.3723	754	731	629	834	845	45.8	4850
CX5-T101-U50	500	0.0366	0.0503	0.3151	0.3138	0.3601	848	821	713	965	973	49.4	6040
CX5-T101-U60	630	0.0283	0.0408	0.3467	0.3039	0.3501	949	908	810	1106	1099	53.1	7440
CX5-T101-U70	800	0.0221	0.0341	0.3864	0.2938	0.3400	1039	990	908	1251	1238	57.8	9375
1 Core - AL/XLPE/PVC													
AX5-T101-U14	50	0.641	0.8220	0.1412	0.4508	0.4970	188	189	152	185	193	29.6	890
AX5-T101-U15	70	0.443	0.5682	0.1567	0.4256	0.4719	228	232	189	232	239	31.2	1005
AX5-T101-U16	95	0.32	0.4106	0.1711	0.4078	0.4540	279	278	222	282	288	32.9	1140
AX5-T101-U17	120	0.253	0.3248	0.1844	0.3927	0.4390	316	320	259	324	332	34.3	1260
AX5-T101-U18	150	0.206	0.2646	0.1976	0.3809	0.4272	354	354	290	367	379	35.9	1405
AX5-T101-U19	185	0.164	0.2110	0.2135	0.3648	0.4111	400	405	322	425	433	37.6	1570
AX5-T101-U20	240	0.125	0.1612	0.2349	0.3505	0.3967	460	468	386	499	513	40.1	1830
AX5-T101-U30	300	0.1	0.1295	0.2571	0.3382	0.3844	517	526	440	575	590	42.7	2105
AX5-T101-U40	400	0.0778	0.1015	0.2820	0.3252	0.3714	591	605	510	672	685	45.6	2475
AX5-T101-U50	500	0.0605	0.0799	0.3142	0.3150	0.3612	679	684	587	786	803	49.5	2950
AX5-T101-U60	630	0.0469	0.0632	0.3462	0.3046	0.3508	772	794	680	909	933	53.2	3520
AX5-T101-U70	800	0.0367	0.0512	0.3900	0.2929	0.3391	870	899	772	1053	1075	58.2	4275

The above data is approximate and subjected to manufacturing tolerance
this data is applicable also for 19/33 KV

18/30 (36) KV Multi Core Unarmoured Cables

Three Core Cables, with stranded circular copper or Aluminum conductors, XLPE insulated, and PVC Sheath.



Description

- Stranded circular compacted copper or aluminum conductor, Semi-conducting layer as conductor screen, XLPE insulated, semi-conducting layer as non metallic insulation screen, copper tape or wire as metallic insulation screen, cores are assembled together with non hygroscopic polypropylene fillers and wrapped with binder tape, and PVC sheathed.
- Cables are produced according to IEC 60502.

Application

- These cables are generally suitable for direct burial or for installation on trays or in ducts.

Product Code	Nominal Cross sectional area	Max. Conductor Resistance		Capacitance	Inductance	Current Rating			Approx. Overall Diameter	Approx. Weight
		DC at 20 °C	AC at 90 °C			Ground	Duct	Laid in free air (Shaded)		
3 Core - Cu/XLPE/PVC										
CX5-T103-U14	50	0.387	0.4937	0.1412	0.4333	236	191	239	62.5	4055
CX5-T103-U15	70	0.268	0.3421	0.1596	0.4052	287	233	292	66.8	4930
CX5-T103-U16	95	0.193	0.2466	0.1711	0.3909	344	280	353	69.6	5825
CX5-T103-U17	120	0.153	0.1958	0.1844	0.3766	391	319	406	72.8	6735
CX5-T103-U18	150	0.124	0.1591	0.1976	0.3645	439	360	461	76	7705
CX5-T103-U19	185	0.0991	0.1276	0.2135	0.3492	497	409	527	79.9	9025
CX5-T103-U20	240	0.0754	0.0979	0.2358	0.3344	577	477	621	85.5	11035
CX5-T103-U30	300	0.0601	0.0790	0.2599	0.3219	657	547	722	91.5	13120
CX5-T103-U40	400	0.047	0.0630	0.2839	0.3110	738	619	817	97.5	15950
CX5-T103-U50	500	0.0366	0.0508	0.3151	0.2993	836	706	941	105.2	19765
3 Core - AL/XLPE/PVC										
AX5-T103-U14	50	0.641	0.8220	0.1412	0.4333	183	148	185	62.5	3200
AX5-T103-U15	70	0.443	0.5682	0.1567	0.4091	223	181	226	66.1	3635
AX5-T103-U16	95	0.32	0.4106	0.1711	0.3909	266	217	274	69.6	4095
AX5-T103-U17	120	0.253	0.3248	0.1844	0.3766	304	248	316	72.8	4545
AX5-T103-U18	150	0.206	0.2647	0.1976	0.3645	341	279	357	76	5030
AX5-T103-U19	185	0.164	0.2110	0.2135	0.3492	387	318	411	79.9	5635
AX5-T103-U20	240	0.125	0.1613	0.2349	0.3350	450	372	484	85.2	6540
AX5-T103-U30	300	0.1	0.1297	0.2571	0.3228	509	424	556	90.8	7535
AX5-T103-U40	400	0.0778	0.1017	0.2820	0.3100	584	489	647	97.1	8815
AX5-T103-U50	500	0.0605	0.0802	0.3142	0.3005	674	568	764	105.5	10505

The above data is approximate and subjected to manufacturing tolerance
this data is applicable also for 19/33 KV

18/30 (36) KV Single Core ATA Cables

Single Core Cables, with stranded Circular copper or Aluminum conductors, XLPE insulated, aluminum tape armoured and PVC Sheath.



Description

- Stranded circular compacted copper or aluminum conductor, Semi-conducting layer as conductor screen, XLPE insulated, semi-conducting layer as non metallic insulation screen, copper tape or wire as metallic insulation screen, covered with a layer of PVC compound as bedding layer, aluminum tape armoured and PVC sheath.
- Cables are produced according to IEC 60502.

Application

- These cables are generally suitable for direct burial or for installation on trays or in ducts.

Product Code	Nominal Cross sectional area	Max. Conductor Resistance		Capacitance	Inductance		Current Rating					Approx. Overall Diameter	Approx. Weight
		DC at 20 °C	AC at 90 °C		Trefoil	Flat	Laid in ground			Laid in free air (Shaded)			
							Flat	Trefoil	Duct	Flat Touched	Trefoil Touched		
		mm ²	Ω/Km		Ω/Km	µf/km	mh/km	A	A	A	A		
1 Core - Cu/XLPE/ATA/PVC													
CX5-T101-B14	50	0.387	0.4937	0.1412	0.4761	0.5223	237	235	200	245	248	33.6	1505
CX5-T101-B15	70	0.268	0.3421	0.1596	0.4466	0.4928	289	287	247	303	309	35.7	1800
CX5-T101-B16	95	0.193	0.2466	0.1711	0.4307	0.4769	347	343	295	365	372	36.9	2085
CX5-T101-B17	120	0.153	0.1957	0.1844	0.4148	0.4610	392	389	373	423	428	38.3	2370
CX5-T101-B18	150	0.124	0.1589	0.1976	0.4021	0.4483	441	435	390	478	485	39.9	2695
CX5-T101-B19	185	0.0991	0.1274	0.2135	0.3860	0.4322	498	489	431	547	552	41.8	3135
CX5-T101-B20	240	0.0754	0.0976	0.2358	0.3698	0.4160	580	504	500	643	648	44.4	3785
CX5-T101-B30	300	0.0601	0.0785	0.2599	0.3558	0.4021	651	630	567	734	736	47.2	4460
CX5-T101-B40	400	0.047	0.0625	0.2839	0.3436	0.3898	736	709	645	847	839	50	5375
CX5-T101-B50	500	0.0366	0.0500	0.3151	0.3309	0.3771	831	789	733	976	955	53.8	6630
CX5-T101-B60	630	0.0283	0.0404	0.3467	0.3198	0.3660	931	871	720	1116	1077	57.5	8075
CX5-T101-B70	800	0.0221	0.0336	0.3864	0.3085	0.3547	1028	946	929	1260	1196	62.2	10065
1 Core - AL/XLPE/ATA/PVC													
AX5-T101-B14	50	0.641	0.8220	0.1412	0.4761	0.5223	184	185	157	189	193	33.6	1220
AX5-T101-B15	70	0.443	0.5682	0.1567	0.4509	0.4971	225	223	196	235	241	35.4	1370
AX5-T101-B16	95	0.32	0.4106	0.1711	0.4307	0.4769	268	269	228	284	291	36.9	1510
AX5-T101-B17	120	0.253	0.3247	0.1844	0.4148	0.4610	307	303	255	328	334	38.3	1640
AX5-T101-B18	150	0.206	0.2646	0.1976	0.4021	0.4483	342	339	294	371	377	39.9	1805
AX5-T101-B19	185	0.164	0.2109	0.2135	0.3860	0.4322	388	384	336	427	433	41.8	2005
AX5-T101-B20	240	0.125	0.1611	0.2349	0.3704	0.4167	449	444	391	502	509	44.3	2290
AX5-T101-B30	300	0.1	0.1294	0.2571	0.3569	0.4032	509	498	414	577	579	46.9	2600
AX5-T101-B40	400	0.0778	0.1013	0.2820	0.3428	0.3890	582	568	510	670	673	49.8	2995
AX5-T101-B50	500	0.0605	0.0797	0.3142	0.3320	0.3782	667	642	586	780	775	53.9	3540
AX5-T101-B60	630	0.0469	0.0630	0.3462	0.3205	0.3667	758	721	699	903	889	57.6	4155
AX5-T101-B70	800	0.0367	0.0508	0.3900	0.3075	0.3537	852	806	769	1042	1013	62.6	4970

The above data is approximate and subjected to manufacturing tolerance
this data is applicable also for 19/33 KV

18/30 (36) KV Multi Core STA Cables

Single Core Cables, with stranded Circular copper or Aluminum conductors, XLPE insulated, steel tape armoured and PVC Sheath.

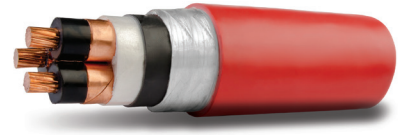

Description

- Stranded circular compacted copper or aluminum conductor, Semi-conducting layer as conductor screen, XLPE insulated, semi-conducting layer as non metallic insulation screen, copper tape or wire as metallic insulation screen, cores are assembled together with non hygroscopic polypropylene fillers and wrapped with binder tape, covered with a layer of PVC compound as bedding, steel tape armoured and PVC sheathed.
- Cables are produced according to IEC 60502.

Application

- These cables are generally suitable for direct burial or for installation on trays or in ducts.

Product Code	Nominal Cross sectional area mm ²	Max. Conductor Resistance		Capacitance µf/km	Inductance mh/km	Current Rating			Approx. Overall Diameter mm	Approx. Weight Kg/Km
		DC at 20 °C Ω/Km	AC at 90 °C Ω/Km			Ground A	Duct A	Laid in free air (Shaded) A		
3 Core - Cu/XLPE/STA/PVC										
CX5-T103-G14	50	0.387	0.4937	0.1412	0.4333	223	186	224	67.5	5550
CX5-T103-G15	70	0.268	0.3421	0.1596	0.4052	273	229	277	72	6560
CX5-T103-G16	95	0.193	0.2466	0.1711	0.3909	325	273	333	74.8	7520
CX5-T103-G17	120	0.153	0.1958	0.1844	0.3766	369	310	381	79.6	9320
CX5-T103-G18	150	0.124	0.1591	0.1976	0.3645	414	349	431	82.6	10360
CX5-T103-G19	185	0.0991	0.1276	0.2135	0.3492	465	395	489	86.7	11850
CX5-T103-G20	240	0.0754	0.0979	0.2358	0.3344	536	456	570	92.5	14100
CX5-T103-G30	300	0.0601	0.0790	0.2599	0.3219	602	515	647	98.5	16395
CX5-T103-G40	400	0.047	0.0630	0.2839	0.3110	676	582	736	104.7	19490
CX5-T103-G50	500	0.0366	0.0508	0.3151	0.2993	757	655	836	112.6	23625
3 Core - AL/XLPE/STA/PVC										
AX5-T103-G14	50	0.641	0.8220	0.1412	0.4333	173	145	174	67.5	4695
AX5-T103-G15	70	0.443	0.5682	0.1567	0.4091	212	177	215	71.3	5245
AX5-T103-G16	95	0.32	0.4106	0.1711	0.3909	253	212	259	74.8	5790
AX5-T103-G17	120	0.253	0.3248	0.1844	0.3766	288	242	297	79.6	7130
AX5-T103-G18	150	0.206	0.2647	0.1976	0.3645	322	272	335	82.6	7685
AX5-T103-G19	185	0.164	0.2110	0.2135	0.3492	364	310	382	86.7	8460
AX5-T103-G20	240	0.125	0.1613	0.2349	0.3350	421	359	447	92.2	9595
AX5-T103-G30	300	0.1	0.1297	0.2571	0.3228	475	407	509	97.8	10785
AX5-T103-G40	400	0.0778	0.1017	0.2820	0.3100	541	466	586	104.3	12335
AX5-T103-G50	500	0.0605	0.0802	0.3142	0.3005	615	532	676	112.9	14380

The above data is approximate and subjected to manufacturing tolerance
this data is applicable also for 19/33 KV

18/30 (36) KV Single Core AWA Cables

Single Core Cables, with stranded Circular copper or Aluminum conductors, XLPE insulated, aluminum wire armoured and PVC Sheath.

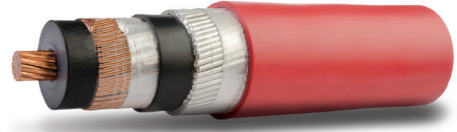

Description

- Stranded circular compacted copper or aluminum conductor, Semi-conducting layer as conductor screen, XLPE insulated, ,semi-conducting layer as non metallic insulation screen, copper tape or wire as metallic insulation screen, covered with a layer of PVC compound as bedding layer, aluminum wire armoured and PVC sheath.
- Cables are produced according to IEC 60502 or BS 6622.

Application

- These cables are generally suitable for direct burial or for installation on trays or in ducts.

Product Code	Nominal Cross sectional area	Max. Conductor Resistance		Capacitance	Inductance		Current Rating					Approx. Overall Diameter	Approx. Weight	
		DC at 20 °C	AC at 90 °C		Trefoil	Flat	Laid in ground			Laid in free air (Shaded)				
							Flat	Trefoil	Duct	Flat Touched	Trefoil Touched			
		mm ²	Ω/Km		Ω/Km	µf/km	mh/km	A	A	A	A			A
1 Core - Cu/XLPE/AWA/PVC														
CX5-T101-X14	50	0.387	0.4937	0.1412	0.4910	0.5372	237	236	202	248	250	36.2	1750	
CX5-T101-X15	70	0.268	0.3420	0.1596	0.4596	0.5058	289	287	247	306	308	38.1	2040	
CX5-T101-X16	95	0.193	0.2465	0.1711	0.4433	0.4895	343	340	294	369	369	39.3	2335	
CX5-T101-X17	120	0.153	0.1957	0.1844	0.4270	0.4732	388	384	334	422	421	40.7	2625	
CX5-T101-X18	150	0.124	0.1589	0.1976	0.4193	0.4656	431	423	373	477	470	43.5	3120	
CX5-T101-X19	185	0.0991	0.1274	0.2135	0.4025	0.4488	483	469	420	541	528	45.4	3575	
CX5-T101-X20	240	0.0754	0.0975	0.2358	0.3854	0.4316	553	528	483	630	608	48	4255	
CX5-T101-X30	300	0.0601	0.0784	0.2599	0.3706	0.4168	616	580	542	715	679	50.8	4955	
CX5-T101-X40	400	0.047	0.0623	0.2839	0.3575	0.4037	687	636	608	811	758	53.6	5900	
CX5-T101-X50	500	0.0366	0.0498	0.3151	0.3432	0.3894	764	692	680	921	844	57.2	7170	
CX5-T101-X60	630	0.0283	0.0402	0.3467	0.3320	0.3782	839	744	753	1033	931	61.1	8675	
CX5-T101-X70	800	0.0221	0.0333	0.3864	0.3197	0.3660	912	792	825	1147	1013	65.8	10725	
1 Core - AL/XLPE/AWA/PVC														
AX5-T101-X14	50	0.641	0.8219	0.1412	0.4910	0.5372	184	184	157	192	195	36.2	1465	
AX5-T101-X15	70	0.443	0.5682	0.1567	0.4640	0.5102	225	224	192	238	242	37.8	1615	
AX5-T101-X16	95	0.32	0.4105	0.1711	0.4433	0.4895	268	267	230	288	290	39.3	1760	
AX5-T101-X17	120	0.253	0.3247	0.1844	0.4270	0.4732	304	302	262	330	332	40.7	1895	
AX5-T101-X18	150	0.206	0.2646	0.1976	0.4193	0.4656	339	336	294	374	374	43.5	2225	
AX5-T101-X19	185	0.164	0.2109	0.2135	0.4025	0.4488	382	378	332	427	424	45.4	2445	
AX5-T101-X20	240	0.125	0.1611	0.2349	0.3861	0.4323	441	432	385	500	492	47.9	2765	
AX5-T101-X30	300	0.1	0.1293	0.2571	0.3717	0.4180	494	479	434	570	555	50.5	3100	
AX5-T101-X40	400	0.0778	0.1012	0.2820	0.3568	0.4030	558	534	494	656	631	53.4	3525	
AX5-T101-X50	500	0.0605	0.0796	0.3142	0.3443	0.3905	630	593	562	755	716	57.3	4080	
AX5-T101-X60	630	0.0469	0.0628	0.3462	0.3326	0.3788	705	651	633	861	805	61.2	4755	
AX5-T101-X70	800	0.0367	0.0506	0.3900	0.3186	0.3649	783	708	709	979	898	66.2	5630	

The above data is approximate and subjected to manufacturing tolerance
this data is applicable also for 19/33 KV

18/30 (36) KV Multi Core SWA Cables

Three Core Cables, with stranded circular copper or Aluminum conductors, XLPE insulated, Steel wire armoured and PVC Sheath.



Description

- Stranded circular compacted copper or aluminum conductor, Semi-conducting layer as conductor screen, XLPE insulated, semi-conducting layer as non metallic insulation screen, copper tape or wire as metallic insulation screen, cores are assembled together with non hygroscopic polypropylene fillers and wrapped with binder tape, covered with a layer of PVC compound as bedding, steel wire armoured and PVC sheathed.
- Cables are produced according to IEC 60502 or BS 6622.

Application

- These cables are generally suitable for direct burial or for installation on trays or in ducts.

Product Code	Nominal Cross sectional area mm ²	Max. Conductor Resistance		Capacitance µf/km	Inductance mh/km	Current Rating			Approx. Overall Diameter mm	Approx. Weight Kg/Km
		DC at 20 °C Ω/Km	AC at 90 °C Ω/Km			Ground A	Duct A	Laid in free air (Shaded) A		
3 Core - Cu/XLPE/SWA/PVC										
CX5-T103-W14	50	0.387	0.4937	0.1412	0.4333	225	189	227	72.6	8370
CX5-T103-W15	70	0.268	0.3421	0.1596	0.4052	275	232	281	77.1	9580
CX5-T103-W16	95	0.193	0.2466	0.1711	0.3909	326	276	336	80.1	10735
CX5-T103-W17	120	0.153	0.1958	0.1844	0.3766	369	311	383	83.3	11810
CX5-T103-W18	150	0.124	0.1591	0.1976	0.3645	412	349	432	86.5	13010
CX5-T103-W19	185	0.0991	0.1276	0.2135	0.3492	462	394	489	90.6	14665
CX5-T103-W20	240	0.0754	0.0979	0.2358	0.3344	529	452	567	96.4	17115
CX5-T103-W30	300	0.0601	0.0790	0.2599	0.3219	591	508	641	102.2	19540
CX5-T103-W40	400	0.047	0.0630	0.2839	0.3110	660	569	724	108.6	22865
CX5-T103-W50	500	0.0366	0.0508	0.3151	0.2993	732	635	817	116.3	27225
3 Core - AL/XLPE/SWA/PVC										
AX5-T103-W14	50	0.641	0.8220	0.1412	0.4333	175	147	176	72.6	7515
AX5-T103-W15	70	0.443	0.5682	0.1567	0.4091	213	179	218	76.4	8275
AX5-T103-W16	95	0.32	0.4106	0.1711	0.3909	254	215	262	80.1	9005
AX5-T103-W17	120	0.253	0.3248	0.1844	0.3766	288	244	299	83.3	9620
AX5-T103-W18	150	0.206	0.2647	0.1976	0.3645	322	273	337	86.5	10335
AX5-T103-W19	185	0.164	0.2110	0.2135	0.3492	363	310	384	90.6	11275
AX5-T103-W20	240	0.125	0.1613	0.2349	0.3350	419	358	447	96.1	12550
AX5-T103-W30	300	0.1	0.1297	0.2571	0.3228	471	404	508	101.5	13885
AX5-T103-W40	400	0.0778	0.1017	0.2820	0.3100	533	460	582	108.2	15725
AX5-T103-W50	500	0.0605	0.0802	0.3142	0.3005	602	522	668	116.6	17970

The above data is approximate and subjected to manufacturing tolerance
this data is applicable also for 19/33 KV

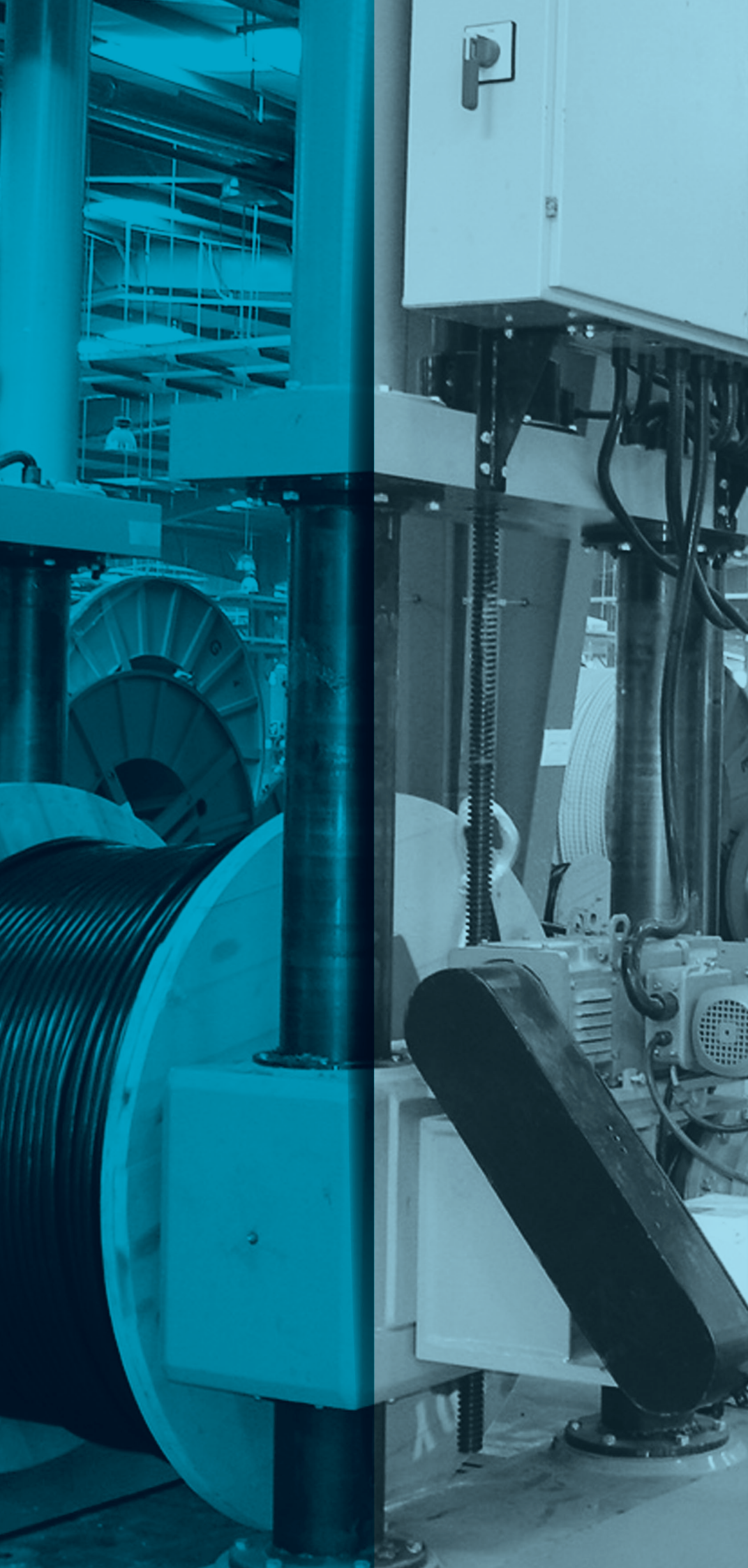

High Voltage & Extra High Voltage Cables

Operating Voltage
(up to 500 kV)

Cable Construction

1. Conductor

Conductor Consists of stranded soft drawn copper or aluminium wires and classified into two major types:

- **Compacted Circular Conductor**

Compacted circular conductor consists of wires wounded up and then compacted

- **Segmental Compacted Conductor**

Segmental conductor consists of 5 segments and is applied for cross-section over than 1000mm² to improve A.C. resistance caused by skin effect. Swelling powder, yarns, tapes inside conductor for conductor water and humidity protection are applicable on request.

It should carry the current in normal operation, emergency and short circuit also the conductor should withstand pulling stress during cable laying

2. Conductor Screen

It consists of an extruded thermoset semi conducting compound to minimize the concentration of electric stresses at any point on the conductor due to the stranded configuration of the conductor. Semi conducting tape with or without water blocking properties can be applied over the conductor and under conductor screen.

3. Insulation

Insulation material is extruded cross-linked polyethylene which extruded over conductor screen. The thickness of the insulation layer is the maximum value figured out from the design of impulse voltage and AC voltage. The cross-linking (Curing) process by Nitrogen gas has been enabled to protect the electrical characteristic from being deteriorated.

Insulation should withstand during service life the rated voltages, lightning over voltage and switching over voltage.

4. Insulation Screen

The insulation screen is a thermoset semi-conducting compound extruded over the insulation to minimize the possibility of ionization on the outer surface of the insulation.

All the three layers (Conductor screen + Insulation + Insulation Screen) are extruded simultaneously in one process to ensure that the screen and insulation are initially bonded together and free from all possibilities of voids between layers.

This process is carried out under strict atmospheric conditions also all materials are very clean and down uploading in closed clean rooms

This process is carried out on CV lines with many measurements devices to control this process perfectly

5. Metallic Screen

It consists of copper or aluminium wires or lead alloy or some times combination of two materials to withstand the required earth fault current within the required duration

6. Outer Jacket

To protect the metallic screen and the cable from the surrounding mechanical or chemical corrosion, it could be PE(LLDPE, MDPE, HDPE) or PVC or LSOH material

7. Semiconductive Jacket (Layer)

a semi conductive layer to be applied as a graphite powder or extruded layer over the anti corrosive layer for jacket field testing after installation



26 / 45 (52) kV

Single core Copper conductor, XLPE insulated Copper wire screen and HDPE sheath (Cu/XLPE/CW/HDPE)



Description

- Stranded circular or segmental compacted copper conductor, semi-conducting layer as conductor screen, XLPE insulated, semi-conducting layer as non metallic insulation screen, Semi-conductive water blocking tape, copper wire as metallic insulation screen to withstand the required earth fault current, non-conductive water blocking tape to protect the screen area from longitudinal water penetration, copolymer aluminum tape to protect the cable from radial water penetration and HDPE sheathed with graphite coating or extruded semi-conducting layer.
- Cables are designed and tested to comply with IEC 60228, 60840 and 60811.

Constructional data (Nominal Values)

Product Code	Conductor			Thickness of Conductor Screen	Thickness of insulation	Thickness of insulation Screen	No. of wires X Wire dia.	Thickness of outer sheath	Approx. outer diameter of cable	Approx. weight of cable	Max. DC conductor resistance at 20 °C	Capacitance
	Nominal Cross sectional area	Shape	Approx. diameter Screen									
	mm ²		mm									
CXG-TX01-K17		Compact round standard	12.7	0.6	9	0.6	59 X 1.04	2	42.2	2600	0.153	0.169
CXG-TX01-K18	120		14.1	0.6	9	0.6	59 X 1.04	2	43.6	2900	0.1240	0.180
CXG-TX01-K19	185		15.8	0.6	9	0.6	59 X 1.04	2.1	45.5	3300	0.0991	0.194
CXG-TX01-K20	240		18.2	0.6	9	0.6	59 X 1.04	2.1	47.9	3900	0.0754	0.213
CXG-TX01-K30	300		20.6	0.6	9	0.6	59 X 1.04	2.2	50.5	4600	0.0601	0.232
CXG-TX01-K40	400		23.2	0.6	9	0.6	59 X 1.04	2.3	53.3	5500	0.0470	0.253
CXG-TX01-K50	500		26.6	0.6	9	0.6	59 X 1.04	2.4	56.9	6600	0.0366	0.280
CXG-TX01-K60	630		30.1	0.6	9	0.6	59 X 1.04	2.5	60.6	8000	0.0283	0.307
CXG-TX01-K70	800		34.5	0.6	9		59 X 1.04	2.7	65.4	9900	0.0221	0.342
CXG-TX01-K80	1000		40	1.2	9	0.6	59 X 1.04	3.5	80.6	13280	0.0176	0.398
CXG-TX01-K81	1200	Segment standard (Milliken)	42.5	1.2	9	1	59 X 1.04	3.5	84.5	15300	0.0151	0.417
CXG-TX01-K83	1600		50.5	1.2	9	1	59 X 1.04	4	91.3	19680	0.0113	0.480
CXG-TX01-K85	2000		55.5	1.4	9	1	59 X 1.04	4	98.1	23050	0.0090	0.524
CXG-TX01-K86	2500		62	1.4	9	1	59 X 1.04	4.5	103.6	28580	0.0072	0.574

continuous current ratings (load factor = 100%) for one circuit in operation (Amperes)

Laying conditions: Trefoil formation				Laying conditions: Flat formation			
Type Of Earthing Bonding System	Nominal Cross sectional area	Direct burial	In air (Shaded)	Type Of Earthing Bonding System	Nominal Cross sectional area	Direct burial	In air (Shaded)
		P_1 in °C cm/W	$T = 30$ °C			P_1 in °C cm/W	$T = 30$ °C
	mm ²	$P_1 = 1.0$ $T = 20$ °C			mm	$P_1 = 1.0$ $T = 20$ °C	
Bonding at both ends	120 R	366	426	Cross or Single point bonding	120 R	427	495
	150 R	409	482		150 R	479	563
	185 R	461	550		185 R	542	646
	240 R	531	647		240 R	629	765
	300 R	596	739		300 R	712	881
	400 R	673	849		400 R	811	1023
	500 R	757	977		500 R	925	1192
Cross or Single point bonding	630 R	895	1167		630 R	1053	1384
	800 R	1000	1332		800 R	1186	1597
	1000 S	1204	1643		1000 S	1382	1916
	1200 S	1298	1788		1200 S	1493	2095
	1600 S	1490	2116		1600 S	1726	2505
	2000 S	1639	2366		2000 S	1913	2828
	2500 S	1788	2631		2500 S	2103	3181

Note: Copper wires cross section area and dimensions are based on the required earth fault current.

R: Round conductor
S: Segmental Conductor

38/66 (72.5) KV

Single core Copper conductor, XLPE insulated Copper wire screen and HDPE sheath (Cu/XLPE/CW/HDPE).



Description

- Stranded circular or segmental compacted copper conductor, semi-conducting layer as conductor screen, XLPE insulated, semi-conducting layer as non metallic insulation screen, Semi-conductive water blocking tape, copper wire as metallic insulation screen to withstand the required earth fault current, non-conductive water blocking tape to protect the screen area from longitudinal water penetration, copolymer aluminum tape to protect the cable from radial water penetration and HDPE sheathed with graphite coating or extruded semi-conducting layer.
- Cables are designed and tested to comply with IEC 60228, 60840 and 60811.

Constructional data (Nominal Values)

Product Code	Conductor			Thickness of Conductor Screen	Thickness of insulation	Thickness of insulation Screen	No. of wires X Wire dia.	Thickness of outer sheath	Approx. outer diameter of cable	Approx. weight of cable	Max. DC conductor resistance at 20 °C	Capacitance
	Nominal Cross sectional area	Shape	Approx. diameter Screen									
	mm ²		mm									
CX6-TX01-K18	150	Compact round standard	14.1	1	10	1	50 x 1.43	3.5	50.8	3650	0.1240	0.173
CX6-TX01-K19	185		15.8	1	10	1	50 x 1.43	3.5	52.7	4075	0.0991	0.186
CX6-TX01-K20	240		18.2	1	10	1	50 x 1.43	3.5	55.1	4700	0.0754	0.203
CX6-TX01-K30	300		20.6	1	10	1	50 x 1.43	3.5	57.5	5400	0.0601	0.221
CX6-TX01-K40	400		23.2	1	10	1	50 x 1.43	3.5	60.1	6260	0.0470	0.239
CX6-TX01-K50	500		26.6	1	10	1	50 x 1.43	4	64.5	7570	0.0366	0.263
CX6-TX01-K60	630		30.1	1	10	1	50 x 1.43	4	68.0	8910	0.0283	0.288
CX6-TX01-K70	800	34.4	1	10	1	50 x 1.43	4	72.3	10900	0.0221	0.319	
CX6-TX01-K80	1000	Segment standard (Miliken)	40	1.5	10	1.2	50 x 1.43	4	80.6	13280	0.0176	0.371
CX6-TX01-K81	1200		43.7	1.5	10	1.2	50 x 1.43	4.5	84.5	15300	0.0151	0.397
CX6-TX01-K83	1600		50.5	1.5	10	1.2	50 x 1.43	4.5	91.3	19680	0.0113	0.444
CX6-TX01-K85	2000		56.5	1.5	10	1.2	50 x 1.43	4.5	98.1	23050	0.0090	0.486
CX6-TX01-K86	2500		62	1.5	10	1.2	50 x 1.43	4.5	103.6	28580	0.0072	0.525

continuous current ratings (load factor = 100%) for one circuit in operation (Amperes)							
Laying conditions: Trefoil formation				Laying conditions: Flat formation			
Type Of Earthing Bonding System	Nominal Cross sectional area	Direct burial	In air (Shaded)	Type Of Earthing Bonding System	Nominal Cross sectional area	Direct burial	In air (Shaded)
		P_1 , in °C cm/W	$T = 30$ °C			P_1 , in °C cm/W	$T = 30$ °C
Bonding at both ends	150	407	485	Cross or Single point bonding	150 R	473	561
	185	458	553		185 R	536	644
	240	526	648		240 R	623	762
	300	589	738		300 R	705	877
	400	662	846		400 R	804	1018
	500	744	968		500 R	916	1183
Cross or Single point bonding	630 R	902	1178		630 R	1043	1373
	800 R	1009	1344		800 R	1176	1584
	1000 S	1212	1653		1000 S	1377	1913
	1200 S	1309	1811		1200 S	1493	2102
	1600 S	1502	2129		1600 S	1720	2499
	2000 S	1656	2395		2000 S	1913	2845
	2500 S	1803	2653	2500 S	2103	3192	

Note: Copper wires cross section area and dimensions are based on the required earth fault current.

R: Round conductor
S: Segmental Conductor

38/66 (72.5) KV

**Single core Copper conductor, XLPE insulated
Lead Sheathed and HDPE sheath
(Cu/XLPE/Lead/HDPE).**



Description

- Stranded circular or segmental compacted copper conductor, semi-conducting layer as conductor screen, XLPE insulated, semi-conducting layer as non metallic insulation screen, semi conductive water blocking tape to protect the screen area from longitudinal water penetration, lead sheathed with suitable thickness to withstand the required earth fault current and HDPE sheathed with graphite coating or extruded semi-conducting layer.
- Cables are designed and tested to comply with IEC 60228, 60840 and 60811.

Constructional data (Nominal Values)

Product Code	Conductor			Thickness of Conductor Screen	Thickness of insulation	Thickness of insulation Screen	Thickness of Lead Sheath	Thickness of outer sheath	Approx. outer diameter of cable	Approx. weight of cable	Max. DC conductor resistance at 20 °C	Capacitance
	Nominal Cross sectional area	Shape	Approx. diameter Screen									
	mm ²		mm	mm	mm	mm	mm	mm	mm	Kg/Km	Ω/Km	µf/km
CX6-TX01-N18	150	Compact round standard	14.1	1	10	1	2.0	3.5	50.3	5720	0.1240	0.173
CX6-TX01-N19	185		15.8	1	10	1	2.0	3.5	52	6260	0.0991	0.186
CX6-TX01-N20	240		18.2	1	10	1	2.1	3.5	54.6	7220	0.0754	0.203
CX6-TX01-N30	300		20.6	1	10	1	2.2	3.5	57.2	8270	0.0601	0.221
CX6-TX01-N40	400		23.2	1	10	1	2.3	3.5	60	9520	0.0470	0.239
CX6-TX01-N50	500		26.6	1	10	1	2.4	4	64.6	11300	0.0366	0.263
CX6-TX01-N60	630		30.1	1	10	1	2.4	4	68.1	13190	0.0283	0.288
CX6-TX01-N70	800	34.4	1	10	1	2.6	4	72.8	15730	0.0221	0.319	
CX6-TX01-N80	1000	Segment standard (Miliken)	40	1.5	10	1.2	2.7	4	80.6	19220	0.0176	0.371
CX6-TX01-N81	1200		43.7	1.5	10	1.2	2.8	4.5	85.5	21690	0.0151	0.397
CX6-TX01-N83	1600		50.5	1.5	10	1.2	3.0	4.5	92.7	27490	0.0113	0.444
CX6-TX01-N85	2000		56.5	1.5	10	1.2	3.2	4.5	99.1	32140	0.0090	0.486
CX6-TX01-N86	2500		62	1.5	10	1.2	3.4	4.5	105	39110	0.0072	0.525

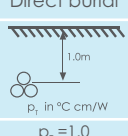
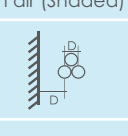
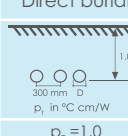
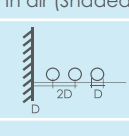
continuous current ratings (load factor = 100%) for one circuit in operation (Amperes)							
Laying conditions: Trefoil formation				Laying conditions: Flat formation			
Type Of Earthing Bonding System	Nominal Cross sectional area	Direct burial	In air (Shaded)	Type Of Earthing Bonding System	Nominal Cross sectional area	Direct burial	In air (Shaded)
		 p_1 in °C cm/W	 T = 30 °C			 p_1 in °C cm/W	 T = 30 °C
	mm ²	$p_1 = 1.0$ T = 20 °C			mm	$p_1 = 1.0$ T = 20 °C	
Bonding at both ends	150 R	414	495	Cross or Single point bonding	150 R	475	564
	185 R	468	565		185 R	537	647
	240 R	540	664		240 R	624	765
	300 R	609	760		300 R	707	882
	400 R	687	874		400 R	806	1023
	500 R	773	1005		500 R	919	1190
Cross or Single point bonding	630 R	899	1182		630 R	1046	1380
	800 R	1001	1346		800 R	1180	1592
	1000 S	1191	1642		1000 S	1380	1917
	1200 S	1282	1793		1200 S	1493	2103
	1600 S	1451	2088		1600 S	1722	2491
	2000 S	1573	2318		2000 S	1912	2823
	2500 S	1684	2535	2500 S	2079	3149	

Note:
Lead Alloy thickness is based on the required earth fault current.

R: Round conductor
S: Segmental Conductor

76/132 (145) KV

Single core Copper conductor, XLPE insulated Copper wire screen and HDPE sheath (Cu/XLPE/CW/HDPE).



Description

- Stranded circular or segmental compacted copper conductor, semi-conducting layer as conductor screen, XLPE insulated, semi-conducting layer as non metallic insulation screen, Semi-conductive water blocking tape, copper wire as metallic insulation screen to withstand the required earth fault current, non-conductive water blocking tape to protect the screen area from longitudinal water penetration, copolymer aluminum tape to protect the cable from radial water penetration and HDPE sheathed with graphite coating or extruded semi-conducting layer.
- Cables are designed and tested to comply with IEC 60228, 60840 and 60811.

Constructional data (Nominal Values)

Product Code	Conductor			Thickness of Conductor Screen	Thickness of insulation	Thickness of insulation Screen	No. of wires X Wire dia.	Thickness of outer sheath	Approx. outer diameter of cable	Approx. weight of cable	Max. DC conductor resistance at 20 °C	Capacitance
	Nominal Cross sectional area	Shape	Approx. diameter Screen									
	mm ²		mm									
CX7-TX01-K20	240	Compact round standard	18.2	1.2	16	1	75 x 1.75	4.5	70.1	6960	0.0754	0.149
CX7-TX01-K30	300		20.6	1.2	16	1	75 x 1.75	4.5	72.5	7710	0.0601	0.160
CX7-TX01-K40	400		23.2	1.2	16	1	75 x 1.75	4.5	75.1	8640	0.0470	0.172
CX7-TX01-K50	500		26.6	1.2	16	1	75 x 1.75	4.5	78.5	9920	0.0366	0.188
CX7-TX01-K60	630		30	1.2	16	1	75 x 1.75	4.5	82	11380	0.0283	0.204
CX7-TX01-K70	800	Segment standard (Miliken)	34.4	1.2	16	1	75 x 1.75	4.5	86.3	13400	0.0221	0.223
CX7-TX01-K80	1000		40	1.5	16	1.2	75 x 1.75	4.5	95.2	15920	0.0176	0.261
CX7-TX01-K81	1200		43.7	1.5	16	1.2	75 x 1.75	4.5	97.1	17840	0.0151	0.269
CX7-TX01-K83	1600		50.5	1.5	16	1.2	75 x 1.75	4.5	105.5	22380	0.0113	0.306
CX7-TX01-K85	2000		56.5	1.5	16	1.2	75 x 1.75	4.5	110.5	26450	0.0090	0.328
CX7-TX01-K86	2500		62	1.5	16	1.2	75 x 1.75	4.5	116.8	31365	0.0072	0.356

continuous current ratings (load factor = 100%) for one circuit in operation (Amperes)							
Laying conditions: Trefoil formation				Laying conditions: Flat formation			
Type Of Earthing Bonding System	Nominal Cross sectional area	Direct burial	In air (Shaded)	Type Of Earthing Bonding System	Nominal Cross sectional area	Direct burial	In air (Shaded)
		mm ²	$p_1 = 1.0$ T = 20 °C			T = 30 °C	mm
Bonding at both ends	240 R	509	635	Cross or Single point bonding	240 R	606	739
	300 R	567	720		300 R	687	850
	400 R	634	820		400 R	784	985
	500 R	706	933		500 R	896	1146
	630 R	904	1173		630 R	1021	1331
Cross or Single point bonding	800 R	1013	1339		800 R	1153	1534
	1000 S	1214	1642		1000 S	1357	1858
	1200 S	1311	1789		1200 S	1467	2033
	1600 S	1512	2121		1600 S	1703	2437
	2000 S	1666	2375		2000 S	1892	2756
	2500 S	1824	2645	2500 S	2085	3103	

Note: Copper wires cross section area and dimensions are based on the required earth fault current.

R: Round conductor
S: Segmental Conductor

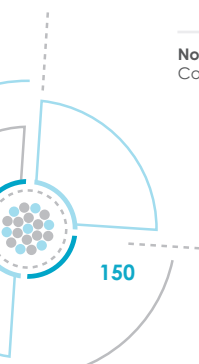

76/132 (145) KV

Single core Copper conductor, XLPE insulated Lead Sheathed and HDPE sheath (Cu/XLPE/Lead/HDPE).



Description

- Stranded circular or segmental compacted copper conductor, semi-conducting layer as conductor screen, XLPE insulated, semi-conducting layer as non metallic insulation screen, semi conductive water blocking tape to protect the screen area from longitudinal water penetration, lead sheathed with suitable thickness to withstand the required earth fault current and HDPE sheathed with graphite coating or extruded semi-conducting layer.
- Cables are designed and tested to comply with IEC 60228, 60840 and 60811.

Constructional data (Nominal Values)

Product Code	Conductor			Thickness of Conductor Screen	Thickness of insulation	Thickness of insulation Screen	Thickness of Lead Sheath	Thickness of outer sheath	Approx. outer diameter of cable	Approx. weight of cable	Max. DC conductor resistance at 20 °C	Capacitance
	Nominal Cross sectional area	Shape	Approx. diameter Screen									
	mm ²		mm									
CX7-TX01-N20	240	Compact round standard	18.2	1.2	16	1	2.4	4.5	69.6	10050	0.0754	0.149
CX7-TX01-N30	300		20.6	1.2	16	1	2.5	4.5	72.2	11220	0.0601	0.160
CX7-TX01-N40	400		23.2	1.2	16	1	2.6	4.5	75	12600	0.0470	0.172
CX7-TX01-N50	500		26.6	1.2	16	1	2.7	4.5	78.6	14450	0.0366	0.188
CX7-TX01-N60	630		30.1	1.2	16	1	2.7	4.5	82.5	16490	0.0283	0.204
CX7-TX01-N70	800		34.4	1.2	16	1	2.9	4.5	86.8	19200	0.0221	0.223
CX7-TX01-N80	1000	Segment standard (Miliken)	40	1.5	16	1.2	3.0	4.5	98.1	24960	0.0176	0.261
CX7-TX01-N81	1200		43.7	1.5	16	1.2	3.1	4.5	100.5	25360	0.0151	0.269
CX7-TX01-N83	1600		50.5	1.5	16	1.2	3.3	4.5	106.8	31480	0.0113	0.306
CX7-TX01-N85	2000		56.5	1.5	16	1.2	3.5	4.5	112.2	36860	0.0090	0.328
CX7-TX01-N86	2500		62	1.5	16	1.2	3.7	4.5	119.9	43200	0.0072	0.356

continuous current ratings (load factor = 100%) for one circuit in operation (Amperes)

Laying conditions: Trefoil formation				Laying conditions: Flat formation			
Type Of Earthing Bonding System	Nominal Cross sectional area	Direct burial	In air (Shaded)	Type Of Earthing Bonding System	Nominal Cross sectional area	Direct burial	In air (Shaded)
		p_1 in °C cm/W	$T = 30$ °C			p_1 in °C cm/W	$T = 30$ °C
	mm ²	$p_1 = 1.0$ $T = 20$ °C			mm	$p_1 = 1.0$ $T = 20$ °C	
Bonding at both ends	240 R	536	661	Cross or Single point bonding	240 R	607	741
	300 R	603	754		300 R	687	853
	400 R	682	866		400 R	784	988
	500 R	767	995		500 R	896	1150
	630 R	896	1170		630 R	1021	1334
Cross or Single point bonding	800 R	1000	1333		800 R	1151	1538
	1000 S	1185	1621		1000 S	1352	1858
	1200 S	1271	1756		1200 S	1459	2029
	1600 S	1437	2057		1600 S	1683	2418
	2000 S	1559	2276		2000 S	1857	2716
	2500 S	1670	2497	2500 S	2026	3027	

Note:
Lead Alloy thickness is based on the required earth fault current.

R: Round conductor
S: Segmental Conductor

127/220 (245) KV

**Single core Copper conductor, XLPE insulated
Copper wire screen and HDPE sheath
(Cu/XLPE/CW/HDPE).**





Description

- Stranded circular or segmental compacted copper conductor, semi-conducting layer as conductor screen, XLPE insulated, semi-conducting layer as non metallic insulation screen, Semi-conductive water blocking tape, copper wire as metallic insulation screen to withstand the required earth fault current, non-conductive water blocking tape to protect the screen area from longitudinal water penetration, copolymer aluminum tape to protect the cable from radial water penetration and HDPE sheathed with graphite coating or extruded semi-conducting layer.
- Cables are designed and tested to comply with IEC 60228, 62067 and 60811.

Constructional data (Nominal Values)

Product Code	Conductor			Thickness of Conductor Screen	Thickness of insulation	Thickness of insulation Screen	Thickness of Lead Sheath	Thickness of outer sheath	Approx. outer diameter of cable	Approx. weight of cable	Max. DC conductor resistance at 20 °C	Capacitance
	Nominal Cross sectional area	Shape	Approx. diameter Screen									
	mm ²		mm	mm	mm	mm	mm	mm	mm	Kg/Km	Ω/Km	µf/km
CX8-TX01-K40	400	Compact round standard	23.2	1.5	23	1.5	75 x 1.75	4.5	90.6	10520	0.0470	0.138
CX8-TX01-K50	500		26.6	1.5	23	1.5	75 x 1.75	4.5	94.1	11870	0.0366	0.149
CX8-TX01-K60	630		30	1.5	23	1.5	75 x 1.75	4.5	97.6	13410	0.0283	0.160
CX8-TX01-K70	800		34.4	1.5	23	1.5	75 x 1.75	4.5	101.9	15530	0.0221	0.174
CX8-TX01-K80	1000	Segment standard (Miliken)	40	1.5	23	1.5	75 x 1.75	5	110.8	18250	0.0176	0.199
CX8-TX01-K81	1200		43.7	1.5	23	1.5	75 x 1.75	5	112.7	20220	0.0151	0.205
CX8-TX01-K83	1600		50.5	1.5	23	1.5	75 x 1.75	5	121.1	24940	0.0113	0.231
CX8-TX01-K85	2000		56.5	1.5	23	1.5	75 x 1.75	5	126.1	28870	0.0090	0.247
CX8-TX01-K86	2500		62	1.5	23	1.5	75 x 1.75	5	132.4	34785	0.0072	0.266

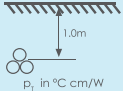
continuous current ratings (load factor = 100%) for one circuit in operation (Amperes)

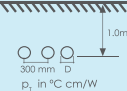
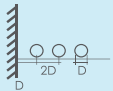
Laying conditions: Trefoil formation				Laying conditions: Flat formation			
Type Of Earthing Bonding System	Nominal Cross sectional area	Direct burial	In air (Shaded)	Type Of Earthing Bonding System	Nominal Cross sectional area	Direct burial	In air (Shaded)
		 P _r in °C cm/W	 T = 30 °C			 P _r in °C cm/W	 T = 30 °C
	mm ²	P _r = 1.0 T = 20 °C	T = 30 °C		mm	P _r = 1.0 T = 20 °C	T = 30 °C
Bonding at both ends	400 R	633	818	Cross or Single point bonding	400 R	761	949
	500 R	707	933		500 R	869	1103
	630 R	894	1152		630 R	991	1278
	800 R	1004	1315		800 R	1118	1471
Cross or Single point bonding	1000 S	1196	1602		1000 S	1317	1779
	1200 S	1292	1745		1200 S	1424	1943
	1600 S	1492	2069		1600 S	1652	2324
	2000 S	1648	2319		2000 S	1835	2624
	2500 S	1806	2584		2500 S	2022	2949

Note: Copper wires cross section area and dimensions are based on the required earth fault current.

R: Round conductor
S: Segmental Conductor

127/220 (245) KV

Single core Copper conductor, XLPE insulated Lead Sheathed and HDPE sheath (Cu/XLPE/Lead/HDPE).



Description

- Stranded circular or segmental compacted copper conductor, semi-conducting layer as conductor screen, XLPE insulated, semi-conducting layer as non metallic insulation screen, semi conductive water blocking tape to protect the screen area from longitudinal water penetration, lead sheathed with suitable thickness to withstand the required earth fault current and HDPE sheathed with graphite coating or extruded semi-conducting layer.
- Cables are designed and tested to comply with IEC 60228, 62067 and 60811.

Constructional data (Nominal Values)

Product Code	Conductor			Thickness of Conductor Screen	Thickness of insulation	Thickness of insulation Screen	Thickness of Lead Sheath	Thickness of outer sheath	Approx. outer diameter of cable	Approx. weight of cable	Max. DC conductor resistance at 20 °C	Capacitance
	Nominal Cross sectional area	Shape	Approx. diameter Screen									
	mm ²		mm									
CX8-TX01-N40	400	Compact round standard	23.2	1.5	23	1.5	3.2	4.5	91.8	17330	0.0470	0.138
CX8-TX01-N50	500		26.6	1.5	23	1.5	3.3	4.5	95.4	19370	0.0366	0.149
CX8-TX01-N60	630		30.1	1.5	23	1.5	3.4	4.5	99.1	21620	0.0283	0.160
CX8-TX01-N70	800		34.4	1.5	23	1.5	3.5	4.5	103.6	24570	0.0221	0.174
CX8-TX01-N80	1000	Segment standard (Milliken)	40	1.5	23	1.5	3.6	5	112.9	29330	0.0176	0.199
CX8-TX01-N81	1200		43.7	1.5	23	1.5	3.9	5	115.2	32290	0.0151	0.205
CX8-TX01-N83	1600		50.5	1.5	23	1.5	4.1	5	123.8	38560	0.0113	0.231
CX8-TX01-N85	2000		56.5	1.5	23	1.5	4.2	5	129.4	43950	0.0090	0.247
CX8-TX01-N86	2500		62	1.5	23	1.5	4.4	5	136.9	49865	0.0072	0.266

continuous current ratings (load factor = 100%) for one circuit in operation (Amperes)

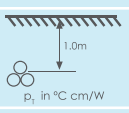
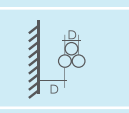
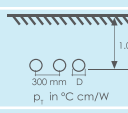
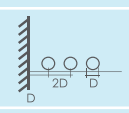
Laying conditions: Trefoil formation				Laying conditions: Flat formation			
Type Of Earthing Bonding System	Nominal Cross sectional area	Direct burial	In air (Shaded)	Type Of Earthing Bonding System	Nominal Cross sectional area	Direct burial	In air (Shaded)
							
		mm ²	$p_t = 1.0$ T = 20 °C			T = 30 °C	mm
Bonding at both ends	400 R	666	848	Cross or Single point bonding	400 R	761	953
	500 R	749	972		500 R	869	1106
	630 R	881	1146		630 R	989	1281
	800 R	983	1304		800 R	1114	1471
Cross or Single point bonding	1000 S	1154	1573		1000 S	1306	1772
	1200 S	1234	1703		1200 S	1407	1931
	1600 S	1393	1989		1600 S	1615	2288
	2000 S	1510	2200		2000 S	1776	2559
	2500 S	1613	2412		2500 S	1926	2882

Note:
Lead Alloy thickness is based on the required earth fault current.

R: Round conductor
S: Segmental Conductor

230/400 (420) KV

Single core Copper conductor, XLPE insulated, Copper Wire Screen, Lead Sheathed and HDPE sheath (Cu/XLPE/CWS/Lead/HDPE).



Description

- Stranded circular or segmental compacted copper conductor, semi-conducting layer as conductor screen, XLPE insulated, semi-conducting layer as non metallic insulation screen, semi conductive water blocking tape to protect the screen area from longitudinal water penetration, combination between copper wires screen and lead sheathed with suitable thickness to withstand the required earth fault current and HDPE sheathed with graphite coating or extruded semi-conducting layer.
- Cables are designed and tested to comply with IEC 60228, 62067 and 60811.

Constructional data (Nominal Values)

Product Code	Conductor			Thickness of Conductor Screen	Thickness of insulation	Thickness of insulation Screen	No. of wires X Wire dia.	Thickness of Lead Sheath	Thickness of outer sheath	Approx. outer diameter of cable	Approx. weight of cable	Max. DC conductor resistance at 20 °C	Capacitance
	Nominal Cross sectional area	Shape	Approx. diameter										
	mm ²		mm										
CXF-TX01-H70	800	Compact	34.5	2.0	35	2.0	85 X 1.35	3.0	5.0	135.6	32875	0.0221	0.1345
CXF-TX01-H80	1000		standard	38.2	2.0	33.5	2.0	84 X 1.35	3.0	5.0	136.3	34565	0.0176
CXF-TX01-H81	1200	Segment standard (Miliken)	42.5	2.0	31.5	2.0	84 X 1.35	3.0	5.0	137.1	36285	0.0151	0.1638
CXF-TX01-H82	1400		47.5	2.0	30.5	2.0	82 X 1.35	3.0	5.0	140.1	38875	0.0129	0.1794
CXF-TX01-H83	1600		50.0	2.0	29.5	2.0	81 X 1.35	3.0	5.1	140.8	40365	0.0113	0.1898
CXF-TX01-H85	2000		55.0	2.0	28.5	2.0	79 X 1.35	3.0	5.2	144.3	44580	0.009	0.208
CXF-TX01-H86	2500		61.8	2.0	27.7	2.0	76 X 1.35	3.0	5.3	149.3	49960	0.0072	0.2312
EXF-TX01-H90	3000 En	69.0	2.0	26.5	2.0	73 X 1.35	3.0	5.4	154.7	56140	0.006	0.2571	

continuous current ratings (load factor = 100%) for one circuit in operation (Amperes)							
Laying conditions: Trefoil formation				Laying conditions: Flat formation			
Type Of Earthing Bonding System	Nominal Cross sectional area	Direct burial	In air (Shaded)	Type Of Earthing Bonding System	Nominal Cross sectional area	Direct burial	In air (Shaded)
		$p_1 = 1.0$ $T = 20\text{ }^\circ\text{C}$	$T = 30\text{ }^\circ\text{C}$			$p_1 = 1.0$ $T = 20\text{ }^\circ\text{C}$	$T = 30\text{ }^\circ\text{C}$
Cross or Single point bonding	800 R	915	1360	Cross or Single point bonding	800 R	1000	1430
	1000 R	1060	1550		1000 R	1165	1730
	1200 S	1120	1620		1200 S	1250	1880
	1400 S	1140	1680		1400 S	1295	1960
	1600 S	1175	1730		1600 S	1330	2025
	2000 S	1255	1920		2000 S	1435	2275
	2500 S	1360	2140		2500 S	1580	2550
	3000 S En	1520	2440		3000 S En	1830	3050

Note:
Copper wires cross section area and dimensions along with Lead Alloy thickness is based on the required earth fault current.

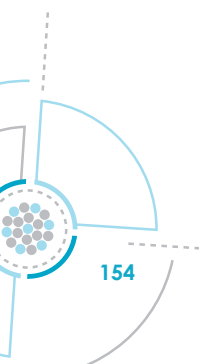

290/500 (550) KV

Single core Copper conductor, XLPE insulated, Copper Wire Screen, Lead Sheathed and HDPE sheath (Cu/XLPE/CWS/Lead/HDPE).



Description

- Stranded circular or segmental compacted copper conductor, semi-conducting layer as conductor screen, XLPE insulated, semi-conducting layer as non metallic insulation screen, semi conductive water blocking tape to protect the screen area from longitudinal water penetration, combination between copper wires screen and lead sheathed with suitable thickness to withstand the required earth fault current and HDPE sheathed with graphite coating or extruded semi-conducting layer.

Constructional data (Nominal Values)

Product Code	Conductor			Thickness of Conductor Screen	Thickness of insulation	Thickness of insulation Screen	No. of wires X Wire dia.	Thickness of Lead Sheath	Thickness of outer sheath	Approx. outer diameter of cable	Approx. weight of cable	Max. DC conductor resistance at 20 °C	Capacitance
	Nominal Cross sectional area	Shape	Approx. diameter										
	mm ²												
CXP-TX01-H81	1200	Segment standard (Miliken)	42.5	2.0	35	2.0	75 X 1.75	3.0	5.3	145.5	39180	0.0151	0.1527
CXP-TX01-H82	1400		47.5	2.0	33.5	2.0	74 X 1.75	3.0	5.3	147.5	41500	0.0129	0.1682
CXP-TX01-H83	1600		50.0	2.0	33	2.0	74 X 1.75	3.0	5.3	149.0	43275	0.0113	0.1755
CXP-TX01-H85	2000		55.0	2.0	31.5	2.0	73 X 1.75	3.0	5.4	151.5	47220	0.009	0.1935
CXP-TX01-H86	2500		61.8	2.0	30.5	2.0	71 X 1.75	3.0	5.6	156.7	52685	0.0072	0.2141
EXP-TX01-H90	3000 En		69.0	2.0	29.5	2.0	69 X 1.75	3.0	5.7	162.1	58915	0.006	0.2369

continuous current ratings (load factor = 100%) for one circuit in operation (Amperes)							
Laying conditions: Trefoil formation				Laying conditions: Flat formation			
Type Of Earthing Bonding System	Nominal Cross sectional area	Direct burial	In air (Shaded)	Type Of Earthing Bonding System	Nominal Cross sectional area	Direct burial	In air (Shaded)
		$p_1 = 1.0$ $T = 20\text{ }^\circ\text{C}$	$T = 30\text{ }^\circ\text{C}$			$p_1 = 1.0$ $T = 20\text{ }^\circ\text{C}$	$T = 30\text{ }^\circ\text{C}$
Cross or Single point bonding	1200 S	1110	1590	Cross or Single point bonding	1200 S	1235	1800
	1400 S	1140	1650		1400 S	1280	1895
	1600 S	1160	1720		1600 S	1315	1975
	2000 S	1250	1890		2000 S	1425	2205
	2500 S	1350	2080		2500 S	1540	2455
	3000 S En	1540	2495		3000 S En	1880	3115

Note: Copper wires cross section area and dimensions along with Lead Alloy thickness is based on the required earth fault current.





Drum Handling, Lifting and Storage guide

Personal protective equipment

Before start dealing with any cable drum, please make sure that all safety precautions are taken, this includes, but not limited to:

- 1- Stout gloves
- 2- Protective footwear
- 3- Eye protection
- 4- Protective clothing
- 5- Helmet



Storage

Cable drums should be stored upright on a flat & firm surface. No drums should be stored on their sides under any circumstances.

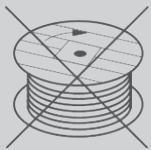

This type of storage is not recommended.

Cable drums should be aligned to insure that no flange of any drum can touch the cable on another drum.

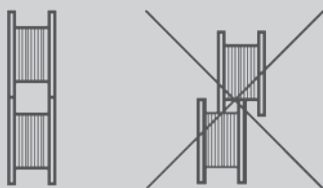

The drums should be aligned as shown.

Cables stored at temperature below the temperatures recommended for installation by the manufacture should be protected from any kind of mechanical stress, like impact, shocks, bending and torsion.

Drum battens and cable end caps should not be removed until the cable is about to be installed.

Suitable wedges should be used to insure that the drum is not able to move after being placed in its position. Wedges must be positioned at flange end and not between them.



The drum should be stood upright, using wedges in the heels of the flanges.

Long term storage

Drums should be stored in a place such as they are protected from UV degradation and direct sunlight, preferred to be indoor with good air ventilation and protected from any heat sources.

Drums should be rolled by 90 Degrees every three months max.

Drum bolts should be checked every one-month max, and fastened whenever necessary.

Lifting and handling

Fork lifts and cranes sufficient to the drum size and weight should be used.

If the drum is required to be rolled, it should be rolled for short distances, and on smooth and solid ground. Rolling should be in the direction indicated by the arrow printed on the drum.

When lifting using a fork lift, the cable drum flanges should be lifted right angle to the fork. The fork should be longer than the width of the drum.



On lifting using a crane, a beam should be used in the cable center hole, and with length larger than the drum width. Another beam should be used from upside to prevent the lifting wires from causing any damage for the drums. Beams should be sufficient for cable drum width and weight. Drum axle should always maintain in horizontal position.



On lowering the drum, make sure that the drum is moving as slow as possible, and avoid any hard impact with the ground. Never drop the drum from any level.

Rewinding:

When cable rewinding is required, same cable drum dimensions should be used. If different drum dimensions to be used, drum weight capacity should be checked before processing. Using drum having barrel diameter less than the diameter of the old drum should be avoided.

Max. applied pulling force and min. bending radius for cable should be respected during rewinding. Motorized pay-off and take-up are always recommended.

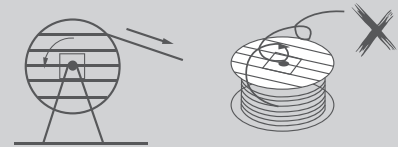

Reverse bending should be avoided.

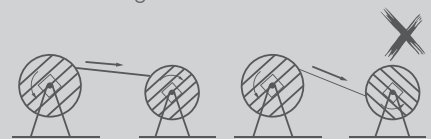

Laying of Power Cables

Applied Laying Depth

Type of Cable	Depth of Laying (cm)
L.V	50 - 80
M.V	80 - 100
H.V	100 - 120
E.H.V	120 - 140

- Cable laying is a major factor affecting the cable life.
- Our Catalogue based on 50 cm for L.V & M.V and 100 cm for H.V & E.H.V

Laying Methods

1- Preparation for the cable

1. The cable should, wherever, be de-coiled from the top of the drum. For this the drum must be positioned such that the arrow on the drum points opposite to the direction of rotation for de-coiling. The drum is lifted on its axle by the aid of winches such that the plank used for braking cannot become wedged beneath.
2. The cable must be inspected for external damage which, e.g. may have been incurred by incorrect rolling of the drum. Since the laying of cables is often carried out by unskilled labor it is necessary to emphasize that the cable is a highvalue commodity and is very sensitive to damage and must be handled with the necessary care.
3. In order to avoid damage to the corrosion protection and the insulation. the cables must not be dragged over sharp objects and must not be bent too sharply (see Table 1).
4. It must be possible to brake the drum at any time in order to avoid. in the event of a sudden stoppage, continuation of decoiling which would result in sharp bending of the cable . Avoidance of kinking is especially critical under all circumstances.
5. Cables must be heated prior to laying where the cable temperature is below (- 5°C) for polymer insulated cables, otherwise the insulation and corrosion protection will be damage during bending. These values apply to the cables themselves and not to the ambient temperature. either the drums must be stored for several days in a heated building or heaters or hot air blowers applied at a sufficient distance. During this warming process the drums should be rotated at intervals.
6. To avoid ingress of moisture it must be observed that the end capping of the cable is not damaged. Cut points of cables must be immediately capped.

Table 1
Minimum permissible bending radii (r) when laying cables

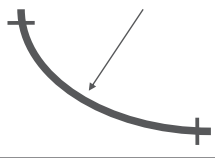
	Polymer insulated cables
Over UO/U = 1.9/3.3kV	
• PE or LSHF jacket	20 X D
• Lead unarmored	18 X D
• Lead armored	15 X D
• PVC jacket	15 X D
Up to UO/U = 1.9/3.3kV	
• PE or LSHF jacket	20 X D
• Lead unarmored	18 X D
• Lead armored	15 X D
• PVC jacket single core or multi armored wire or unarmored	8 X D
• PVC jacket single core or multi armored tape or shield tape	15 X D

2- Laying of Cables in the Ground

2.1 Cable Route

1. For the progression of a cable route in built-up areas it is most suitable to use a paved pedestrian area or in overland routes to follow a foot path. The depth of trench is dependent on the number of cable to be laid above one another in the same trench, furthermore in urban areas and on industrial sites it also depends on any gas or water pipes which exist or may be laid in the future.
2. The cable laying uppermost below a paved pedestrian area or foot path should be at a depth not less than 0.6m and below roads at a depth of not less than 0.8m. Where cable are laid at shallower depths they must be protected by e.g. concrete slabs of sufficient thickness.
3. The cables are normally covered with a layer of sand or stone-free (sieved) soil 10 cm thick and then, to protect against surface damage during subsequent earth workings, are covered with bricks, plastic plates or similar devices. If covers are not provided warning tapes of plastic are normally used to mark the cable route.
4. Where high-voltage and low-voltage cables are laid in the same trench, it is the practice to lay the high-voltage cable in the lowest position. The high-voltage cable are then embedded in sand and covered by protective slabs. Above these on an additional layer of sand the low-voltage cables are laid. In such a cable arrangement the current load capacity, because of the mutual heating effect and drying out of the soil, is reduced .
5. If control cables and high-voltage cables run on parallel routes for any great distance the magnitude of interference must be investigated. The same applies where the route is in close proximity to or crosses railway installations or communication networks of the post office.

2.2 Crossing of Roads

1. When the route crosses a roadway the cables must be drawn into pipes or cable duct blocks which extend beyond and under the pavements.
2. It is advisable always to provide reserve space in pipes or pipe ducts to avoid the necessity to reexcavate when adding cable at a later date. Pipe cavities which are not occupied immediately should be sealed off.
3. The pipe bore should have a diameter of at least 1.5 times the outer diameter d of the cable. Pipe bends should, in respect of pulling the cable through, have a minimum radius corresponding to those shown in table 2.0 where for the value of d the pipe outer diameter should be used.

Table 2
Minimum permissible bending radii (r) for pipes

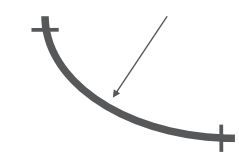
	PVC Pipes	PE Pipes
Based on DR factor		
• 9 or less	200 X D	20 X D
• 11, 13.5	250 X D	25 X D
• 17, 21	270 X D	27 X D
• 26	340 X D	34 X D

DR: dimension ratio: average outer diameter divided by minimum wall thickness

3- Cable Laying Methods

The following methods may be employed for laying cables:

- Paying out from a cable trailer
- Laying by hand
- Laying by motor driven rollers
- Pulling off by winches
- Ploughing in.

3.1 Paying out from a Cable Trailer

Providing there are no obstructions in the trench or its vicinity, cable may be paid out direct from the cable trailer. However it must be ensured that during the paying out the drum is manually rotated and braked in accordance with the laying speed to avoid hightensile force or sharp bending of the cable.

3.2 Laying by Hand

Cable rollers placed at distances of between 3 to 4m make laying easier. Corner rollers or similar devices should be provided at any bend in the route, always maintaining the minimum bending radii of the cable .

If the cable is not guided by rollers it must be guided by hand. The men supporting the cable should be spaced at between 4 to 6 m along the cable.

3.3 Laying by Motor Driven Rollers

Motorized rollers are used to pull the cable off the jacked up drum. It is advantageous to use rollers driven by electric motors installed in the cable trench at distances of 20 to 30 m. Where sharp bends occur it may be necessary to place such a roller at both the commencement and the end of the bend.

3.4 Pulling off by winches

Pulling off by winch is possible only if there are very few bends or other obstructions in the route.

After releasing the cable end from the drum a pulling stocking is placed over the end and tied in position. A rope is secured to the eye of the pulling stocking .

When laying unarmoured cables or steel-tape armoured cables with the aid of a winch, the rope can be secured to the cable via a pulling head which grips directly on to the conductors.

All cables, in particular single-core cables should not be straightened after laying, but left slightly meandering, to allow for longitudinal expansion and contraction during thermal cycling (changes in current loading).

Table 3
Permissible pulling force (guide values)

Means of pulling	Type of cable	Formula	Factor
With pulling head attached to conductors	All type of cable	$P = \sigma \cdot A$	$\sigma = 50 \text{ N/mm}^2$ (Cu-conductor) $\sigma = 30 \text{ N/mm}^2$ (Al- conductor)
With pulling stocking	Cable with metal sheath without pull resistant armouring.	$P = K \cdot d^2$	$K = 3 \text{ N/mm}^2$

When laying 3 single-core cable simultaneously with a common pulling stocking the same maximum pulling force applies, whereas the pulling force for 3 laid-up single-core cables is 3 times that of a single-core and for 3 non-laidup single-core cable is 2 time that of a single core.

- P Pull in N
 A Total cross sectional area in mm of all conductors (but not screen or concentric conductor)
 d Outside diameter of cable in mm
 σ Permissible tensile stress of conductor in N/ mm²
 K Empirically derived factor in N/ mm²

3.5 Plough-laying of Cables

In open terrain the cables may be plough-laid directly into the ground where circumstances permit, no obstructions, e.g. pipe runs which cross the route, and where protection of the cable with plastic plates or similar is not acceptable. This type of cable laying is particularly cost effective. Cables with PE sheath are particularly suitable for this form of laying .

4- Laying of Single-Core Cables

For the laying of single-core cables under practical conditions, depending on local circumstances several methods have proved effective:

- Pulling-off and laying individual lengths in sequence,
- Simultaneously pulling-off three lengths from three cable drums.
- Laying of three pre-laid-up cables,
- Plough laying of three bunched cables.

If the three lengths are laid in sequence care must be taken that the cable already laid is not damaged by the cables following (e.g. by chaffing or abrasive action).

If on site sufficient space is available the simultaneous pulling off of three single-core cables from three individual drums has advantages. In a bunching bench the three cables are brought together for bunching in triangular formation for bunching and can then be laid as a single cable. The system is also proven where the three drums are carried on a suitably adapted flat back lorry.

5- Cable Tunnels and Ducts

The main advantage of using cable tunnels or ducts is the ease of access for replacement or extension of the installation without extensive workings.

Especially, where there is great cable massing, the cables installed in ducts can normally be subjected to higher loading than when laid in the ground. A disadvantage is the high cost of supply and installation of the ducts. For this reason installation in ducts is normally restricted to buildings and around outdoor switch gear plant.

In walk through ducts (cable tunnels) the cables are for practical reasons laid on cable trays above one another. Multi-core cables which are laid horizontally on the duct floor or on the trays do not require fixing.

The cables should be laid in the duct with a space between each approximately equal to the cable diameter. The load capacity of the cable may be determined. Since this is dependent on ambient air temperature a good natural ventilation should be provided in the duct (openings for ingoing and outgoing air).

Where necessary forced ventilation must be provided. With due consideration of the possibility of spreading of fire the cable ducts must be with barriers at least at the point of entry into operation rooms, switching stations, etc.

6- Side Wall Pressure

To preclude damage to the cable from the dynamic radial pressure, which develops when a cable is pulled around a bend under pulling tension, this pressure must be kept as low as possible.

Permissible maximum side wall pressure to the cable at bending point during installation is 1000 kg/m.

$$\text{NOTE: Side wall pressure to cable} = \frac{\text{pulling tension (kgf)}}{\text{bending radius (m)}} = \frac{T}{R}$$

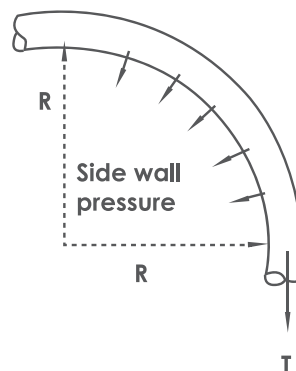

T: Pulling tension (kgf)
R: Bending radius (m)

Earthing of Single Core H.V. and E.H.V. Cables

Distribution voltage cables are normally installed with solidly bonded sheaths and, in order to minimize the sheath circulating currents on single-core cables produced by the magnetic flux linking the conductors and sheaths, they are nearly always laid in close touching trefoil formation. However, trefoil formation is poor for heat dissipation, as the three cables have a considerable heating effect upon one another. This is generally not a limitation for cable system at 33 kV but with larger conductor sizes and higher voltages alternative "specially bonded" systems are more economic.

Special bonding involves earthing the single-core cable sheaths at one point only and insulating all other points of the sheath from earth, so that the circulating sheath losses are eliminated and the phase cables can design be spaced apart to reduce their mutual heating effect without increasing sheath losses.

If one termination only is grounded, the sheaths are subjected to a standing voltage of zero at the ground connection and maximum at the point furthest from this connection. This voltage is proportional to the conductor current and cable spacing. To protect the sheath insulation against transient voltages arising from lightning or switching transients it is therefore necessary to fit sheath voltage limiters (SVLs) at all joint and sealing end positions where the sheath is insulated from earth.

Three basic variations of specially bonded systems are commonly used: single end bonding, mid-point bonding and cross-bonding.

Specially Bonded Cable Systems

Single End Bonding System

In this system the sheaths at one termination are earthed and at the other termination are insulated from ground and fitted with SVLs. It is necessary to provide a separate earth continuity conductor for fault currents which would normally return via the cable sheaths. The standing voltage is proportional to the cable length and therefore the voltage limitation imposes a limitation on the length of the cable that may be bonded in this manner.

Diagram showing the principle of a power line earthing at one point

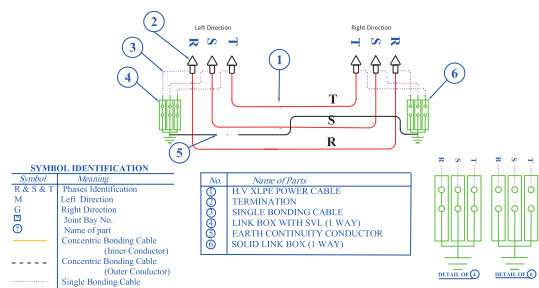

Mid-point Bonding System

Bonding of the mid-point is used where the route length is too long to employ a single end bonding system. In this system the cable is earthed at the mid-point (at joint) of the route and is insulated from ground and provided with SVLs at each termination or vice versa. It can be seen that this doubles the possible route length as the maximum allowable standing voltage can be tolerated at each sealing end or joint.

Earthing system mid-point

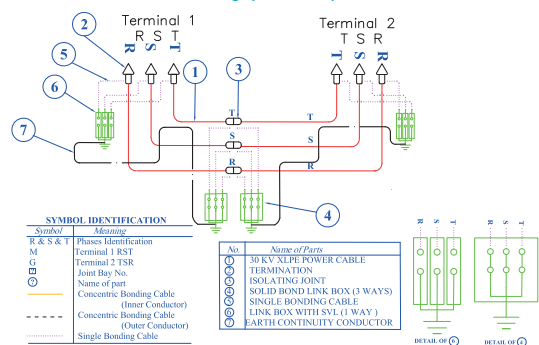

Cross-bonding System

In long routes, the route is split up into "major" sections, each comprised of three lengths and special joints are fitted. At each third joint position the sheaths are connected together and at all other positions they are connected so that all sheaths occupying the same position in the cable trench are connected in series. The sheaths at the intermediate positions are also connected to SVLs. The three sheaths connected in series are associated with conductors of different phases and when the cables are installed in trefoil formation their currents, and hence the sheath voltages, have equal magnitude but phase displacements of 120°. The overall effect is that the resultant voltage and current in the three sheaths are zero. When cables are laid in flat formation the voltages induced in the sheaths of the outer cable are greater than induced on the sheath of the middle cable and the phasor sum is not zero. The cables are therefore transposed at every joint position and the cross-connections are made with a phase rotation opposite to that of transposition so that the sheaths are effectively straight connected.

Cross - bonding system

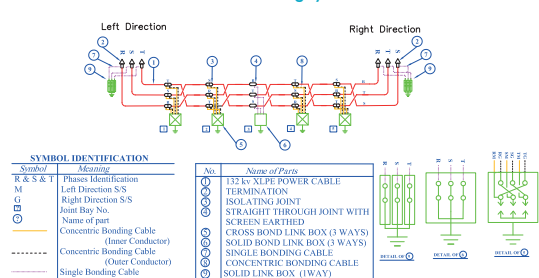

Cables Clarification Sheet

Rated Voltage

- | | | | | |
|---|------------------------------------|--|--|------------------------------------|
| <input type="checkbox"/> 450/750 V | <input type="checkbox"/> 0.6/1 kV | <input type="checkbox"/> 1.8/3 kV (1.9/3.3 kv) | <input type="checkbox"/> 3.6/6 kV (3.8/6.6 kV) | <input type="checkbox"/> 26/45 kV |
| <input type="checkbox"/> 6/10 kV (6.35/11 kV) | <input type="checkbox"/> 8.7/15 kV | <input type="checkbox"/> 12/20 kV (12.7/22 kV) | <input type="checkbox"/> 18/30 kV (19/33 kV) | <input type="checkbox"/> 64/110 kV |
| <input type="checkbox"/> 38/66 kV | <input type="checkbox"/> 76/132 kV | <input type="checkbox"/> 127/220 kV | | <input type="checkbox"/> 87/150 kV |
| | | | | <input type="checkbox"/> 500 kV |

Conductor C.S.A = mm²

- | | | | | |
|------------------------------------|--------------------------------|-----------------------------------|-----------------------------------|-----------------------------------|
| <input type="checkbox"/> Copper | <input type="checkbox"/> Solid | <input type="checkbox"/> Stranded | <input type="checkbox"/> Flexible | <input type="checkbox"/> Milliken |
| <input type="checkbox"/> Aluminium | <input type="checkbox"/> Solid | <input type="checkbox"/> Stranded | | |

Insulation

- | | | | |
|------------------------------|------------------------------------|-------------------------------|-------------------------------|
| <input type="checkbox"/> PVC | <input type="checkbox"/> PVC - F.R | <input type="checkbox"/> XLPE | <input type="checkbox"/> LSHF |
|------------------------------|------------------------------------|-------------------------------|-------------------------------|

Copper Screen Short Circuit Current = kA

- | | | |
|--------------------------------------|--------------------------------------|---|
| <input type="checkbox"/> Copper Wire | <input type="checkbox"/> Copper Tape | <input type="checkbox"/> Copper (Tape + Wire) |
|--------------------------------------|--------------------------------------|---|

Metallic Sheath

- | | | |
|-------------------------------|-------------------------------------|-----------------------------------|
| <input type="checkbox"/> Lead | <input type="checkbox"/> Lead Alloy | <input type="checkbox"/> Aluminum |
|-------------------------------|-------------------------------------|-----------------------------------|

Armour

- | | | | |
|-----------------------------------|-------------------------------|--|--|
| <input type="checkbox"/> Steel | <input type="checkbox"/> Tape | <input type="checkbox"/> Galvanized Tape | <input type="checkbox"/> Galvanized Wire |
| <input type="checkbox"/> Aluminum | <input type="checkbox"/> Tape | <input type="checkbox"/> Wire | |

Sheathing (Overall Jacket)

- | | | | |
|--------------------------------|------------------------------------|-------------------------------------|-------------------------------|
| <input type="checkbox"/> PVC | <input type="checkbox"/> PVC - F.R | <input type="checkbox"/> HDPE | <input type="checkbox"/> LSHF |
| <input type="checkbox"/> LLDPE | <input type="checkbox"/> MDPE | <input type="checkbox"/> Other | |



System's Certificates

BASEC
BEST APPROVAL SERVICE FOR CABLES

Certificate No: **CS1-185/002.2**

Certificate of Conformity

BASEC hereby certifies that: **Egytech Cables (EI Sewedy)**
10th of Ramadan City
Industrial Zone A3, Cairo, Egypt

Has implemented and maintains a Management System that fulfills the requirements of: **BS EN ISO 9001:2015**

In respect of the location listed above and for the following scope of activities:

Scope of Certification:
The design, development, manufacture and supply of: Building Wires, Indoor Wires, Control and Low Voltage Cables up to 1 kV, Medium Voltage Cables up to 36 kV, High Voltage Cables up to 150 kV, Extra High Voltage Cables up to 500 kV, Overhead Transmission Lines up to 500 kV, Optical Ground Wires and Solar Cables, Recycling of Cables.

Issue no: 13
Date of initial certification: 06/02/2007
Issue date: 11/08/2023

Signed for and on behalf of BASEC Group Ltd
Karam O'Brien Date: 11/08/2023

If the conditions set out in the certification agreement are not fulfilled this Certificate may be suspended/invalid. This certificate does not confirm product conformity in any way and is issued subject to ongoing surveillance for continued compliance, and in accordance with BASEC's Regulations.

BASEC Group Ltd, Priority House, Priority Way, Milton Keynes, MK9 3PL, UK
Telephone: +44 (0)1295 252222, Fax: +44 (0)1295 252222

Expiry date: 04/11/2028

EURO CERT

CERTIFICATE

EUROCERT certifies that the company: **EI Sewedy Cables, Egytech Cables - Egypt.**
Industry Zone A3, 10th of Ramadan, Cairo, Egypt
Industry Zone A3, 10th of Ramadan, Cairo, Egypt
implements Occupational Health and Safety Management System according to the Standard: **EN ISO 14001:2015**
for the following Scope of Certification:

DESIGN, MANUFACTURE AND SUPPLY OF:
• BUILDING WIRES, INDOOR WIRES, CONTROL AND LOW VOLTAGE CABLES UP TO 1 kV.
• MEDIUM VOLTAGE CABLES UP TO 36 kV.
• HIGH VOLTAGE CABLES UP TO 150 kV.
• EXTRA HIGH VOLTAGE CABLES UP TO 500 kV.
• OVERHEAD TRANSMISSION LINES UP TO 500 kV AND EXECUTION OF TURN KEY PROJECTS FOR 220 kV.
• OPTICAL GROUND WIRES INCLUDING INSTALLATION.

On behalf of EUROCERT
Sifirius George
International Markets Director of Eurocert SA - Greece

Loss of fulfillment of the conditions set out in the contract No. 00000212, makes this Certificate invalid. Check the validity of the certificate with the CE mark at right. The certificate is subject to annual surveillance.

EUROCERT S.A. - 18, Olympos & Sifirius Str., 15125, Marousi, Greece
T: +30 210 5232444, F: +30 210 5232457, E: info@eurocert.com, www.eurocert.com

EURO CERT

CERTIFICATE

EUROCERT certifies that the company: **EI Sewedy Cables, Egytech Cables - Egypt.**
Industry Zone A3, 10th of Ramadan, Cairo, Egypt
Industry Zone A3, 10th of Ramadan, Cairo, Egypt
implements Occupational Health and Safety Management System according to the Standard: **ISO 45001:2018**
for the following Scope of Certification:

DESIGN, MANUFACTURE AND SUPPLY OF:
• BUILDING WIRES, INDOOR WIRES, CONTROL AND LOW VOLTAGE CABLES UP TO 1 kV.
• MEDIUM VOLTAGE CABLES UP TO 36 kV.
• HIGH VOLTAGE CABLES UP TO 150 kV.
• EXTRA HIGH VOLTAGE CABLES UP TO 500 kV.
• OVERHEAD TRANSMISSION LINES UP TO 500 kV AND EXECUTION OF TURN KEY PROJECTS FOR 220 kV.
• OPTICAL GROUND WIRES INCLUDING INSTALLATION.

On behalf of EUROCERT
Sifirius George
International Markets Director of Eurocert SA - Greece

Loss of fulfillment of the conditions set out in the contract No. 00000212, makes this Certificate invalid. Check the validity of the certificate with the CE mark at right. The certificate is subject to annual surveillance.

EUROCERT S.A. - 18, Olympos & Sifirius Str., 15125, Marousi, Greece
T: +30 210 5232444, F: +30 210 5232457, E: info@eurocert.com, www.eurocert.com

Accreditation Certificate No. (211021A)

Arab Republic of Egypt
Egyptian Accreditation Council (EGAC)
Certifies that **EI Sewedy Cables Laboratory (A3)**
Industrial Zone (A3) - 10th of Ramadan City
Shariya Governorate - Egypt
Has been accredited by EGAC in compliance with the requirements of **ISO/IEC 17025:2017**
In Some Electrical and Non Electrical Tests for Power Cables
The scope of accreditation is described in the attached schedule No. (211021B)
Scope Issue No.(04)

Issue No. (04): December 01, 2020 Valid to: August 13, 2024

Subject to continued compliance to the above standard and the requirements of EGAC

EGAC is an ILAC/MRA Signatory in the Field of Calibration, Testing, Medical Labs, Proficiency Testing Providers and Inspection Bodies Accreditation

1st Accreditation Date: August 14, 2012

Eng. Hany El Desouki
EGAC Executive Director

Nevein Gamea
Chairman of EGAC
Minister of Trade and Industry

EURO CERT

CERTIFICATE

EUROCERT certifies that the company: **ELSEWEDY CABLES- EGYTECH CABLES - EGYPT.**
Industrial Zone A3, 10th of Ramadan, 10 Shariya, Egypt
Industry Zone A3, 10th of Ramadan, 10 Shariya, Egypt
implements Continuity Management System according to the Standard: **ISO 37301:2021**
for the following field of application:

Design, Manufacture and supply of:
• BUILDING WIRES, INDOOR WIRES, CONTROL AND LOW VOLTAGE CABLES UP TO 1 kV.
• MEDIUM VOLTAGE CABLES UP TO 36 kV.
• HIGH VOLTAGE CABLES UP TO 150 kV.
• EXTRA HIGH VOLTAGE CABLES UP TO 500 kV.
• OVERHEAD TRANSMISSION LINES UP TO 500 kV AND EXECUTION OF TURN KEY PROJECTS FOR 220 kV.
• OPTICAL GROUND WIRES INCLUDING INSTALLATION, LEAD AND EXPORT CERTIFICATION.

On behalf of EUROCERT S.A.
Sifirius George
Director of International Markets

Loss of fulfillment of the conditions set out in the contract No. 00000212, makes this Certificate invalid. Check the validity of the certificate with the CE mark at right. The certificate is subject to annual surveillance.

EUROCERT S.A. - 18, Olympos & Sifirius Str., 15125, Marousi, Greece
T: +30 210 5232444, F: +30 210 5232457, E: info@eurocert.com, www.eurocert.com

EURO CERT

CERTIFICATE

EUROCERT certifies that the company: **EL SEWEDY CABLES, EGYTECH CABLES - EGYPT.**
Industry Zone A3, 10th of Ramadan, Cairo, Egypt
Industry Zone A3, 10th of Ramadan, Cairo, Egypt
implements a Business Continuity Management System according to the Standard: **ISO 22301:2019**
for the following Scope of Certification:

DESIGN, MANUFACTURE AND SUPPLY OF:
• BUILDING WIRES, INDOOR WIRES, CONTROL AND LOW VOLTAGE CABLES UP TO 1 kV.
• MEDIUM VOLTAGE CABLES UP TO 36 kV.
• HIGH VOLTAGE CABLES UP TO 150 kV.
• EXTRA HIGH VOLTAGE CABLES UP TO 500 kV.
• OVERHEAD TRANSMISSION LINES UP TO 500 kV AND EXECUTION OF TURN KEY PROJECTS FOR 220 kV.
• OPTICAL GROUND WIRES INCLUDING INSTALLATION.

On behalf of EUROCERT S.A.
Sifirius George
Director of International Markets

Loss of fulfillment of the conditions set out in the contract No. 00000212, makes this Certificate invalid. Check the validity of the certificate with the CE mark at right. The certificate is subject to annual surveillance.

EUROCERT S.A. - 18, Olympos & Sifirius Str., 15125, Marousi, Greece
T: +30 210 5232444, F: +30 210 5232457, E: info@eurocert.com, www.eurocert.com

EURO CERT

CERTIFICATE

EUROCERT certifies that the company: **EL SEWEDY CABLES, EGYTECH CABLES - EGYPT.**
Industry Zone A3, 10th of Ramadan, Cairo, Egypt
Industry Zone A3, 10th of Ramadan, Cairo, Egypt
implements an Energy Management System according to the Standard: **EN ISO 50001:2018**
for the following Scope of Certification:

DESIGN, MANUFACTURE AND SUPPLY OF: - BUILDING WIRES, INDOOR WIRES, CONTROL AND LOW VOLTAGE CABLES UP TO 1 kV. - MEDIUM VOLTAGE CABLES UP TO 36 kV. - HIGH VOLTAGE CABLES UP TO 150 kV. - EXTRA HIGH VOLTAGE CABLES UP TO 500 kV. - OVERHEAD TRANSMISSION LINES UP TO 500 kV AND EXECUTION OF TURN KEY PROJECTS FOR 220 kV. - OPTICAL GROUND WIRES INCLUDING INSTALLATION.

On behalf of EUROCERT
Sifirius George
Director of International Markets

Loss of fulfillment of the conditions set out in the contract No. 00000212, makes this Certificate invalid. Check the validity of the certificate with the CE mark at right. The certificate is subject to annual surveillance.

EUROCERT S.A. - 18, Olympos & Sifirius Str., 15125, Marousi, Greece
T: +30 210 5232444, F: +30 210 5232457, E: info@eurocert.com, www.eurocert.com

Product's Certificates

DNV-GL

KEMA TEST REPORT 1727-18

Object Power cable system consisting of 1-core power cable, 2 outdoor terminations, 1 joint and 1 GIS sealing end (wet type) 290/300 (S40) kV – 1x2500 mm² – ECU – XLPE

Client Elsewedy Cables, 10th of Ramadan City Industrial Zone A3, Egypt

Manufacturer Elsewedy Cables, 10th of Ramadan City Industrial Zone A3, Egypt

Accessories See section 1.1.3 Characteristics of the accessories

Tested by KEMA B.V., Kingdombelweg 155, Arnhem, the Netherlands

Date of tests 26 September 2018 until 16 January 2019

Test specification The tests have been carried out in accordance with client's instructions. Test procedure and test parameters were based on IEC 62067:2011.

Summary and conclusion The object passed the tests.

This report applies only to the object tested. The responsibility for conformity of any object having the same type references as that tested rests with the Manufacturer. It is declared by the manufacturer that this report consists of 99 pages in total.

KEMA B.V.
Bureau Veritas
Director, High-Voltage Laboratory
Arnhem, 25 October 2020

Industry & Facilities Division Page 1 of 5

Third Party Inspection Report

INSPECTION REPORT Nr. EG/IAH/2023/0004/006 Revision Nr. 0

Inspection requested by: EL SEWEDY CABLES - EGYPT

Inspection performed as Recognized Authority: Yes, (Recognized) No

Project: TYPE TEST FOR MV POWER CABLE 193KV

BY Client: EL SEWEDY CABLES - EGYPT IPO Ref. (if applicable): (BY external PO)

Manufacturer/Vendor: EL SEWEDY CABLES - EGYPT P. n. n. (refer to BY)

Sub-Vendor: N/A P. n. n. (refer to Manufacturer)

Inspection location: 10th OF RAMADAN CITY, INDUSTRIAL ZONE 3, EGYPT

Inspection performed on: Starting 15 May 2023 and end on 4 June 2023 days stopping are 15.16.17.21.22.23.30.31 May 2023.8.9 and 4 June 2023/16 days

Previous inspection: Not Applicable

Next inspection: As per client request

MATERIAL / SUBJECT OF INSPECTION	ITEM / TAG N°	QTY As per IPO	QTY Offered for inspection
Power Cable 1x1000 ALXLPE/CW/SHDPE Voltage 193kV (S40) kV	WO 5084/2022	One Drum	One Drum

A - INSPECTION RESULT:

Satisfactory (Without comments) Satisfactory with comments (Any of testing Purposes or Non Conformity items is still open) Not Satisfactory (NCR raised during the inspection)

Inspection Summary: (In details refer to section E)

A Power Cable 1x1000mm² ALXLPE/CW/SHDPE 193kV (S40) kV was offered by El Sewedy Cables-Egypt for witnessing Test tests on mentioned Cable according to IEC 62067-1:2011 and found satisfactory at time of inspection.

Open Non Conformities: Yes, details in section G No

Open Punch List Items: Yes, details in section H No

Release Note issued: Yes, number(s): (Please refer to section J) No

By Traceability Stamping: Yes, No

BY Inspector: Mohamed Samir BY Coordinator: Mohamed Samir

BY Office: Cairo - Egypt Inspection Report Date: 8 June 2023

Dispositions: CLIENT BY MANUFACTURER OTHER

GM-S-101 INSPECTION Rev. 3 Copyright Bureau Veritas 10/2019

TEST REPORT Report No. (897) 2019

CLIENT: EL SEWEDY CABLES, 10th of Ramadan City, Industrial Zone (A3).

Report Date: 3/10/2019

Place: LABORATORIES OF EXTRA HIGH VOLTAGE RESEARCH CENTER - Internal Code: TO-AC-19-00-12 - 01.

Standard Specification: IEC 62067 (2011) "Power cables with extruded insulation and their accessories for rated voltages above 150 kV (Um=170 kV) up to 500 kV (Um = 550 kV)." **Requirements:** Type tests according to IEC 62067.

Description of The Specimen: Loop System content of power cable, cross-bonding joint, Outdoor porcelain sealing end with the following specification:

- 1- **Power cable 230 kV with the following specification:**
 - Manufacturer : EL SEWEDY CABLES
 - Type : 120 kV/CU/CLPE/CW/SHDPE - 1x2000 mm².
 - No. of Phases : 1
 - Insulation : XLPE
 - Conductor Material : Copper
 - Conductor cross-section : 2000 mm²
 - CW/SH : CW/SH
 - Sheath Material : HDPE-ST
 - Sheath Color : Black
 - Rated Frequency : 50 Hz
 - Water Penetration Design : A barriers are included which prevents longitudinal water penetration along the conductor (swelling powder), the outer surface of the conductor (water blocking tapes), the gap between the outer surface of the insulation screen and the metallic screen and the metallic screen (water blocking tape)

VEIKI-VNI No. 13239/VNI

ELECTRIC LARGE LABORATORIES LTD. TESTING LABORATORY Page 1 of 32

TYPE TEST REPORT

Test object: Overhead line conductor

Designation: ACS8 9515

Manufacturer: Elsewedy Cables Industrial Area A3, 10th of Ramadan City, Egypt

Tested for: Siemens Mobility GmbH, Werner-von-Siemens-Str. 67, 91052 Erlangen Germany

Date of tests: 17th May 2023 - 09th October 2023

Project ID: NAL-29-2023

Order/Contract: PO: 02420/2023 11.04.2023

Test specifications: EN 50182:2001 Conductors for overhead lines - Round wire concentric lay stranded conductors
EN 50183:2000 Conductors for overhead lines - Zinc coated steel wires
IEC 62461:2012 Conductors for overhead lines - Aluminium and aluminium alloy wires for concentric lay stranded conductors
EN 50234:2003 Conductors for overhead lines - Characteristics of galvanized steel

Tests performed: The test object, constructed in accordance with the description, drawings and photographs incorporated in this report has been subjected to the following tests: Verification of construction and DC resistance measurement, Tensile break test and Strain-stress test and Stripping test, Individual wire testing and drop tests of galvanized steel.

Test results: The test object fulfilled the relevant requirements of the standard. This document has been issued by VEIKI-VNI Electric Large Laboratories Ltd. Testing Laboratory in accordance with above mentioned test specifications. This document applies only to the test object. The responsibility for conformity of any product having the same designation with the test object rests with the Manufacturer. This document comprises 32 pages in total (32 numbered pages, 2 pages of annex and 1 page of test report of galvanized steel).

17th October, 2023
László Nodeman, Notifier responsible for the test
Norbert Mészáros, Supervisor
Balázs Varga, head of laboratory

1155 Budapest, Vagyóly u. 2-4., HUNGARY
E-mail: VEIKI-VNI@veiki.com
Phone: +36-1-47-3157
www.veiki.hu

KEMA Labs

INSPECTION REPORT 3144-22

Test object Power cable system consisting of single-core power cable, 1 outdoor termination and 1 cross-bonding joint

Ca/ALPE/ANS-FQ/HDPE 130/230 (S45) kV 1x2500 mm²

Manufacturer Cable: Elsewedy Cables, Industrial Zone A3, 10th of Ramadan City, Egypt
Accessory 1: B-ring Kabel AG, Industriestraße 15, 5200 Brugg, Switzerland
Accessory 2: B-ring Kabel AG, Industriestraße 15, 5200 Brugg, Switzerland

Client B-ring Kabel AG, Industriestraße 15, 5200 Brugg, Switzerland

Details of tests Request 16 to 26 September 2022

Test location Kingdombelweg 155, Arnhem, the Netherlands

Test specifications The tests were in accordance with IEC 62067:2022

Regarding Type Tests

This report applies only to the individual object tested. KEMA Labs makes no representations or warranties, expressed or implied, other than the object tested. It is the responsibility of the applicable device manufacturer to ensure that any other devices or units having the same name and description as the test object are identical.

This report comprises 79 pages in total.

Issued by KEMA B.V.
Services & Smart Technologies
Arnhem, February 10, 2023

Tests on ACS8 Hen Conductor
K-31209-RP-0001 R00

Prepared for Elsewedy Cables
Purchase Order #: PO 7/022-R02

Issue Date 2023-Mar-20

Prepared by: Heide Liu, MEng
Reviewed by: Tyler Gilmore
Approved by: André Maurice

Project Manager: Service Line Manager
Transmission & Distribution Technologies

KINETRICS INC., 803 Kipling Ave, Unit 2, Markham, Ontario, Canada www.kinetrics.com
Proprietary and Confidential

IMQ Rapporto di valutazione Nr. CN20-005-061-02

REPORTO DI VALUTAZIONE Evaluation Report No.

Prova Richiesta da: EISEWEDY CABLES
P301 no. 2P 1 x 1000mm² 10th Settlement New Cairo Cairo Egypt

Costruttore: EISEWEDY CABLES
P301 no. 2P 1 x 1000mm² 10th Settlement New Cairo Cairo Egypt

1. OGGETTO IN PROVA: Cavo Laminato di Alto Tensione
High voltage single core cable

Segno di designazione: AR641HSE - 1x1600 mm² - 87/150 kV

Segno del costruttore: AKCH0MCH8F-0004 - ALXLPE/CW/SHDPE 1x1600 mm² - 87/150 kV

2. SCOPO DELLE PROVE: Prova di invecchiamento a lunga termine per la verifica sui componenti del rivestimento laminato (profilo longitudinale) secondo la modalità contenuta nel documento di riferimento. Lunga tempo aging di superficie e di spessore di rivestimento di isolamento secondo la modalità descritta nel documento di riferimento.

3. DOCUMENTI DI RIFERIMENTO: Vedi pagina 2 del presente rapporto

4. DATA RICEVIMENTO CAMPIONI / SEM: Copie di campioni ricevuti: 08/01/2023

5. DATA DELLE PROVE: Dal 20/03/2023 al 02/07/2023

Il presente Rapporto di prova è compilato da: 7 pagine di cui (pagine including):
7 pagine di rapporto (pages of report)
7 pagine di allegati (extra pages)

Approvato da: C. MAZZUCCHI
Reporto Tecnico (Technical Report)

Revisione: 01/01/2023
Descrizione della Revisione: Prima emissione / First edition

Mod. TRF 3003/2 Pagina 1 di 7

DEKRA Page 2 of 55

TYPE TEST REPORT 2275637 01-AMV-23-0027

TYPE TEST REPORT

OBJECTS 132 kV AC power cable, 1 x 1000 mm²
76/132 (145) kV – 1x1000 mm² – Cu/XLPE/CW/SHDPE/ST/HDPE

CLIENT EGYTECH CABLES (ELSEWEDY CABLES), 10th of Ramadan City, Egypt

MANUFACTURER EGYTECH CABLES (ELSEWEDY CABLES), 10th of Ramadan City, Egypt

REFERENCE 227563700

INSPECTED BY DEKRA Certification B.V., Arnhem, The Netherlands

TEST LOCATION EGYTECH CABLES (ELSEWEDY CABLES), 10th of Ramadan City, Egypt

DATE(S) OF TESTS 18 April to 25, May 2023

TEST SPECIFICATION The tests have been carried out in accordance with IEC 60940 (2020)

SUMMARY AND CONCLUSION The cable passed the type tests.

This report applies only to the object tested. The responsibility for conformity of any object having the same type references as that tested rests with the manufacturer. This report consists of 55 pages in total.

DEKRA Certification B.V.
H.L. Schenkendijk
Certification Manager
Medium & High Voltage Components

Arnhem, 8 June 2023
© DEKRA Certification B.V. All rights reserved
DEKRA Certification B.V. and/or its subsidiaries are not liable for any direct, indirect, incidental or consequential loss (including through or because of the use of the information in this document) or any other loss whatsoever.

DEKRA Certification B.V. Meentze 1081, 6825 MJ Arnhem, P.O. Box 9166, 6820 EN Arnhem, The Netherlands
+31 (0) 48 42 21 21 | +31 (0) 48 42 109 | info@dekra.com | www.dekra.com | Company registration: 61848382

Copyright: Only integral reproduction of this report is permitted without written permission from DEKRA. Electronic copies in e.g. PDF format or scanned version of this report may be available and have the status: "for information only". The printed end-bracket content of this report is the only valid version.

Our Partners



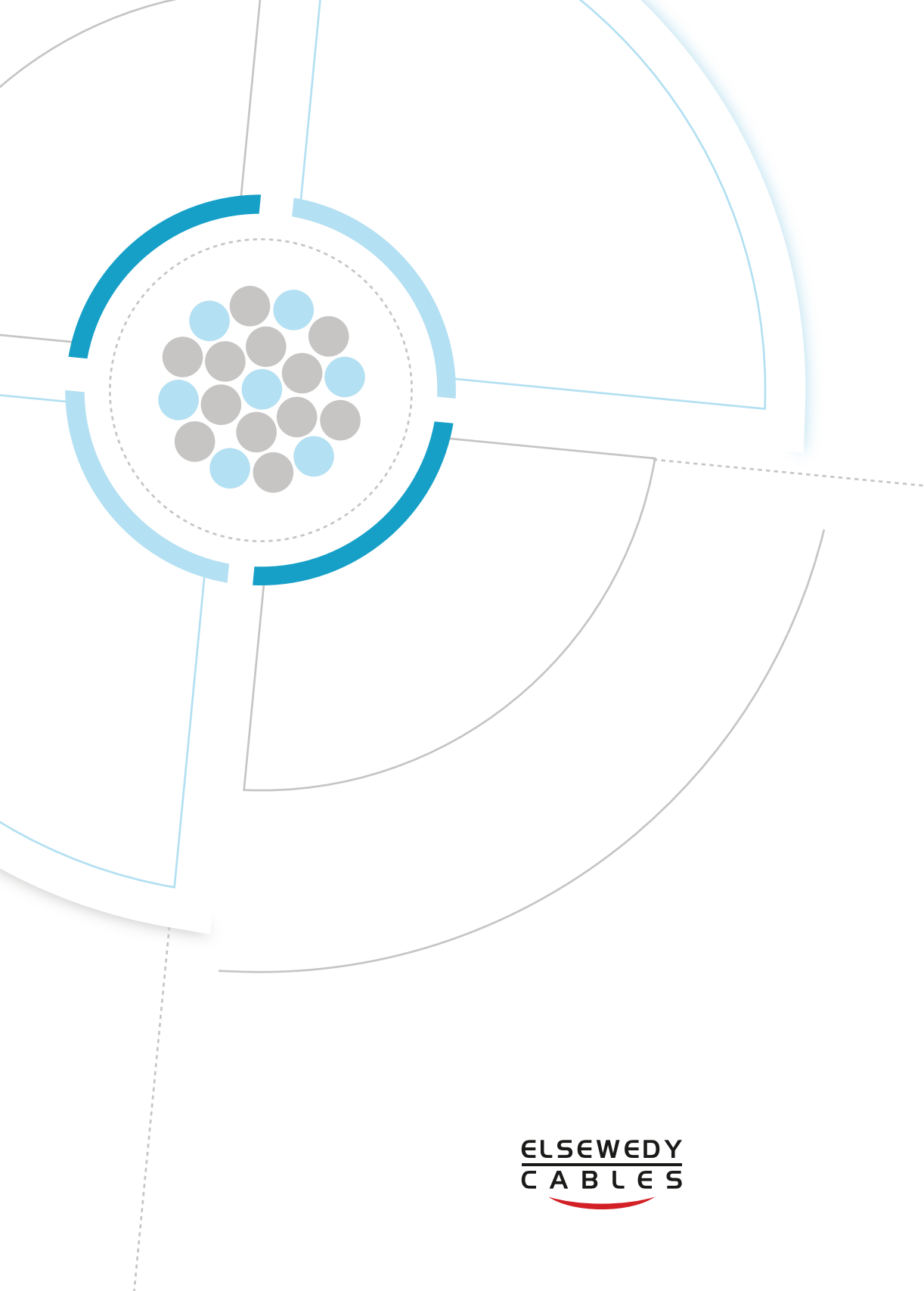

ELSEWEDY
CABLES

POWER CABLES CATALOGUE
POWER TO RELY ON

Plot No. 13co3, Cairo Festival City, 5th Settlement,
P.O.Box 310, New Cairo, Egypt
Tel.: +202 275 99 700 / 1
Fax: +202 275 99 731
E-mail: info@elsewedy.com

www.elsewedy.com

 **19159**